



# CITY

5-12

7993



2+3+4



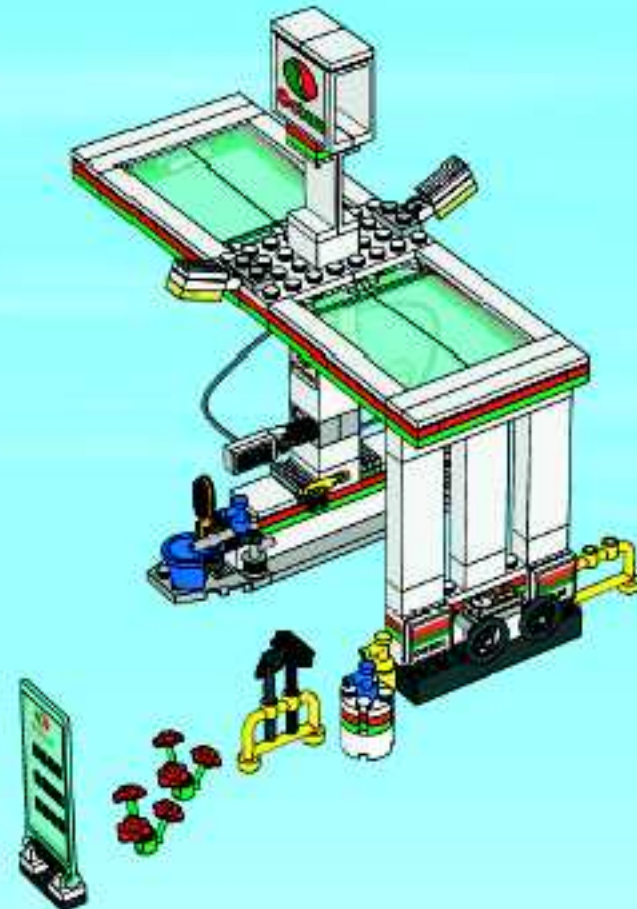
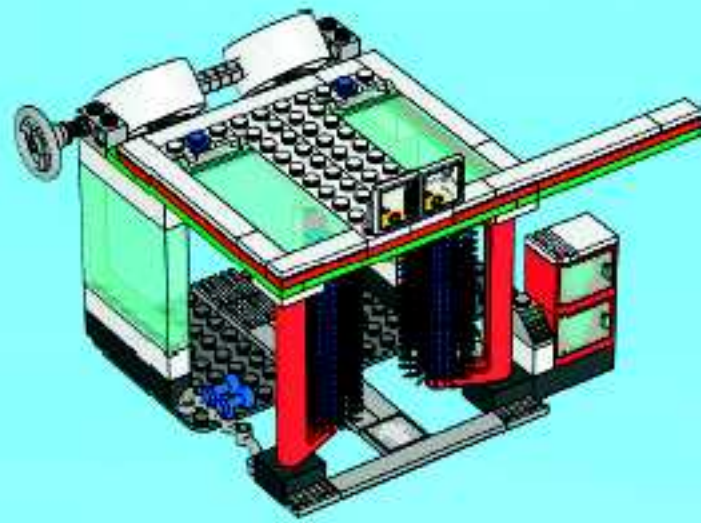
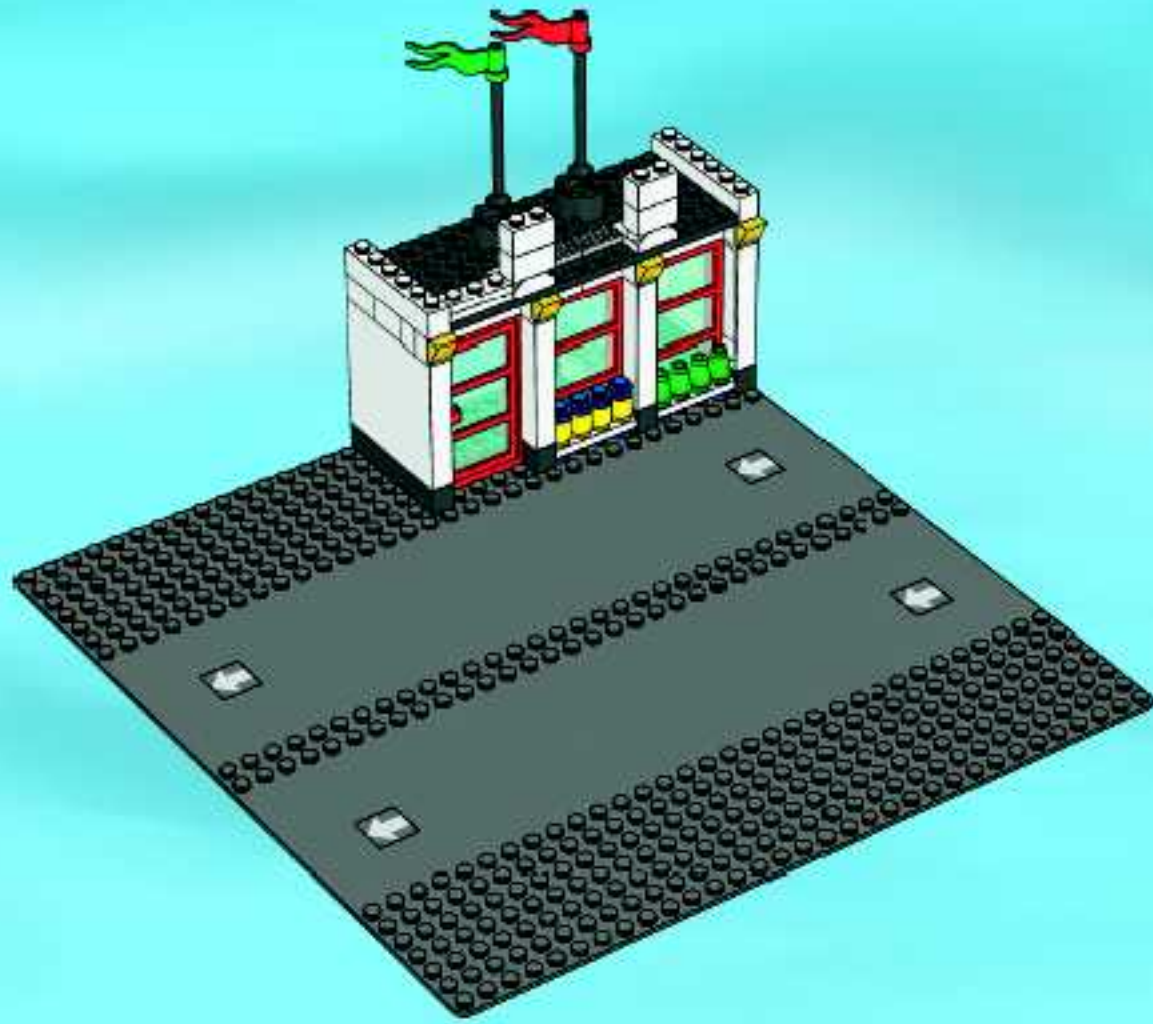



1

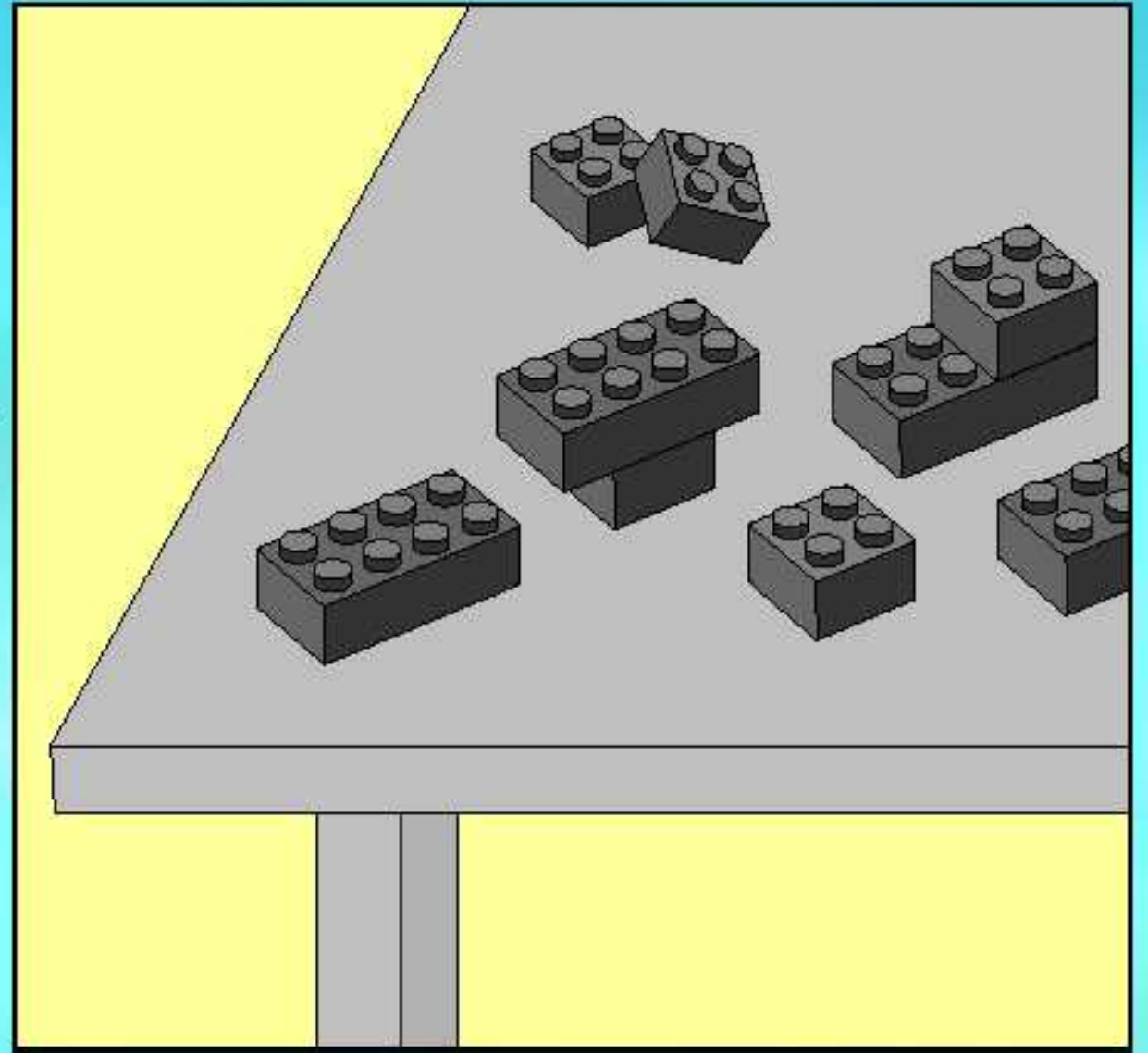
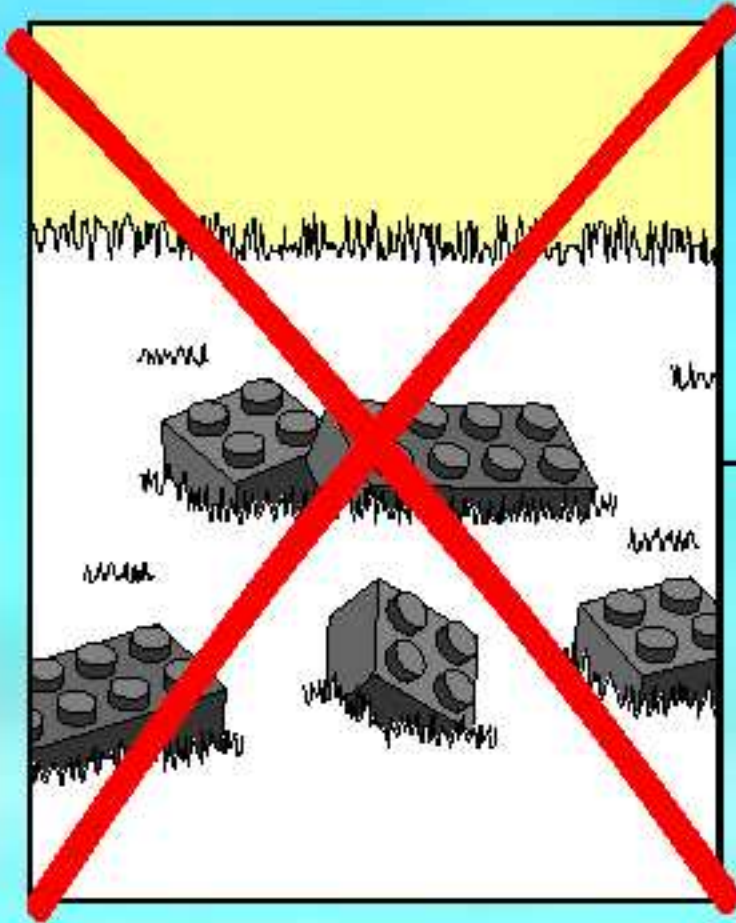

2





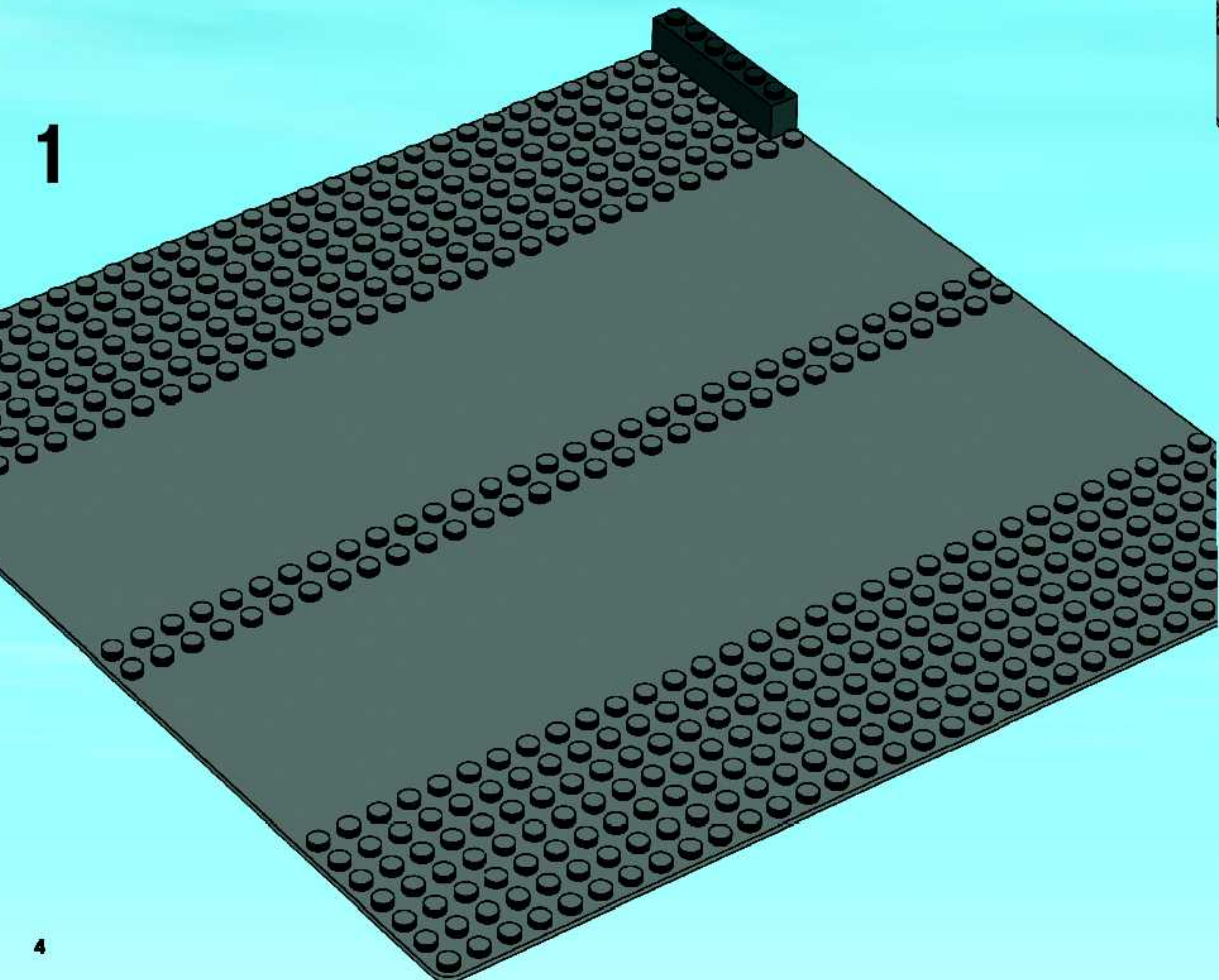
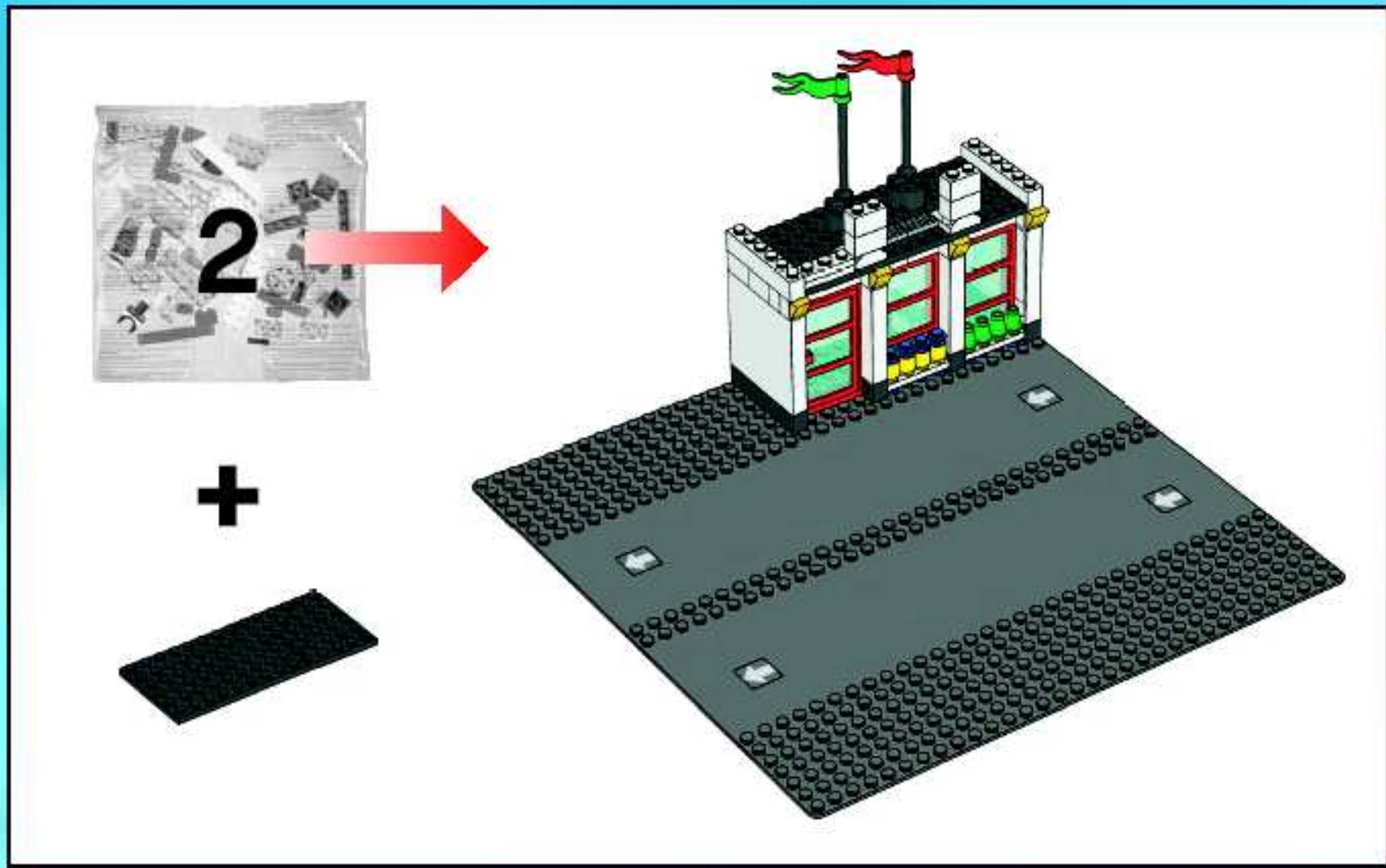



2

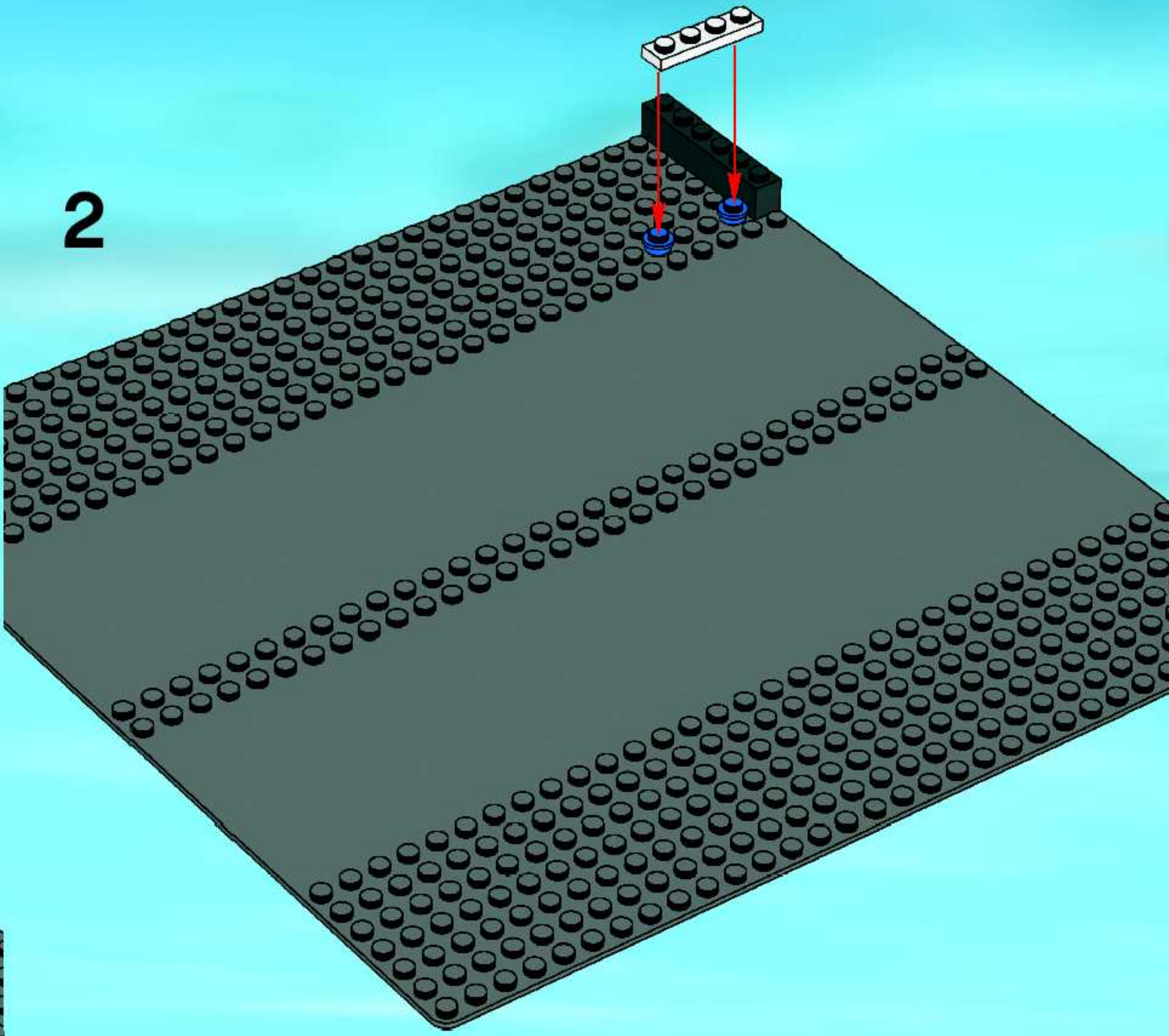



3

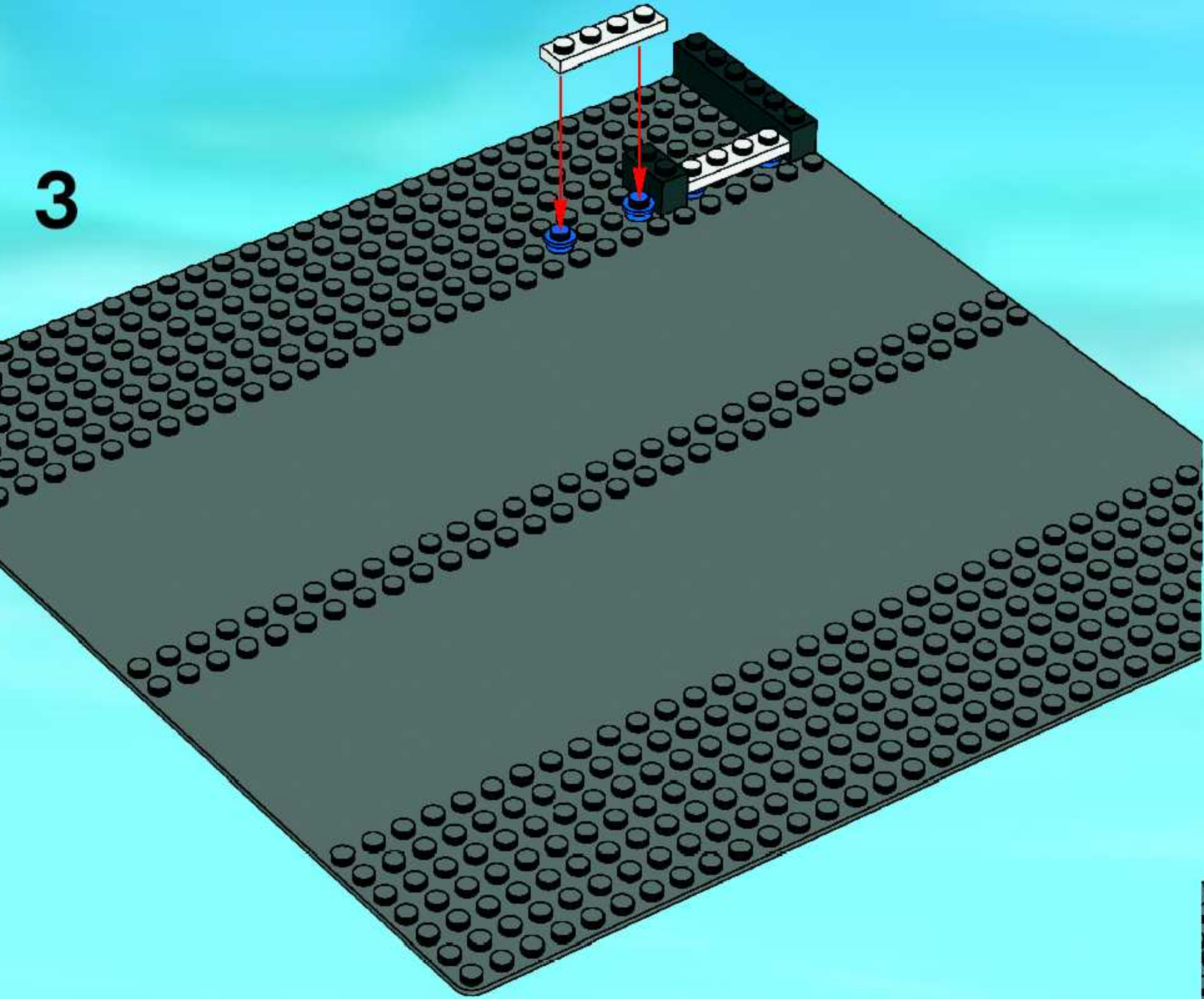



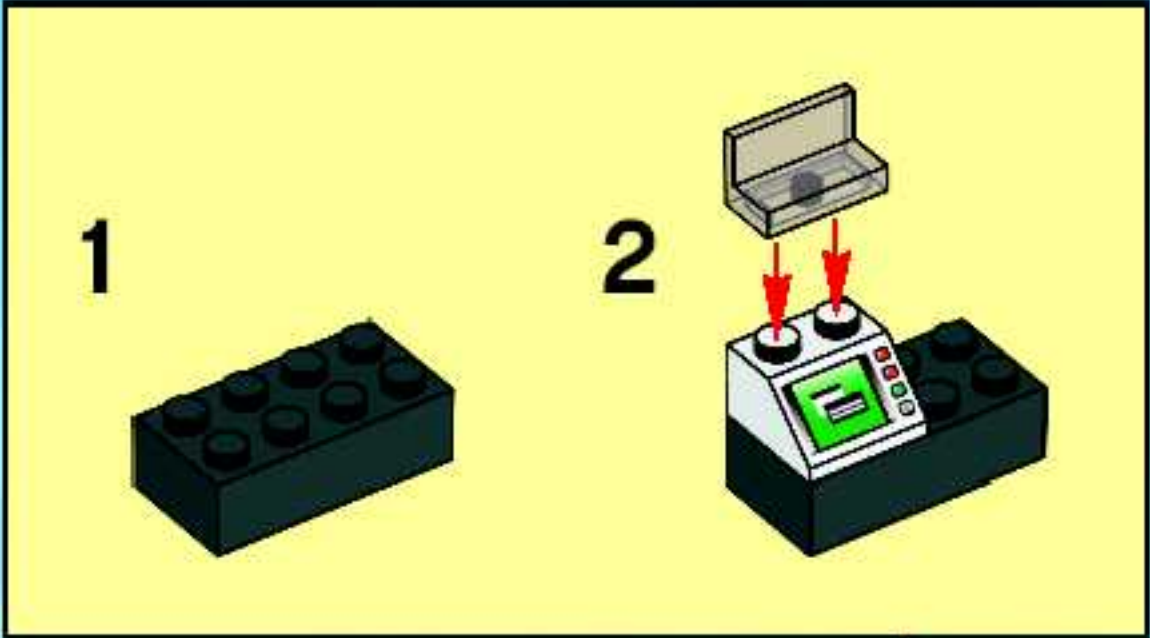

4

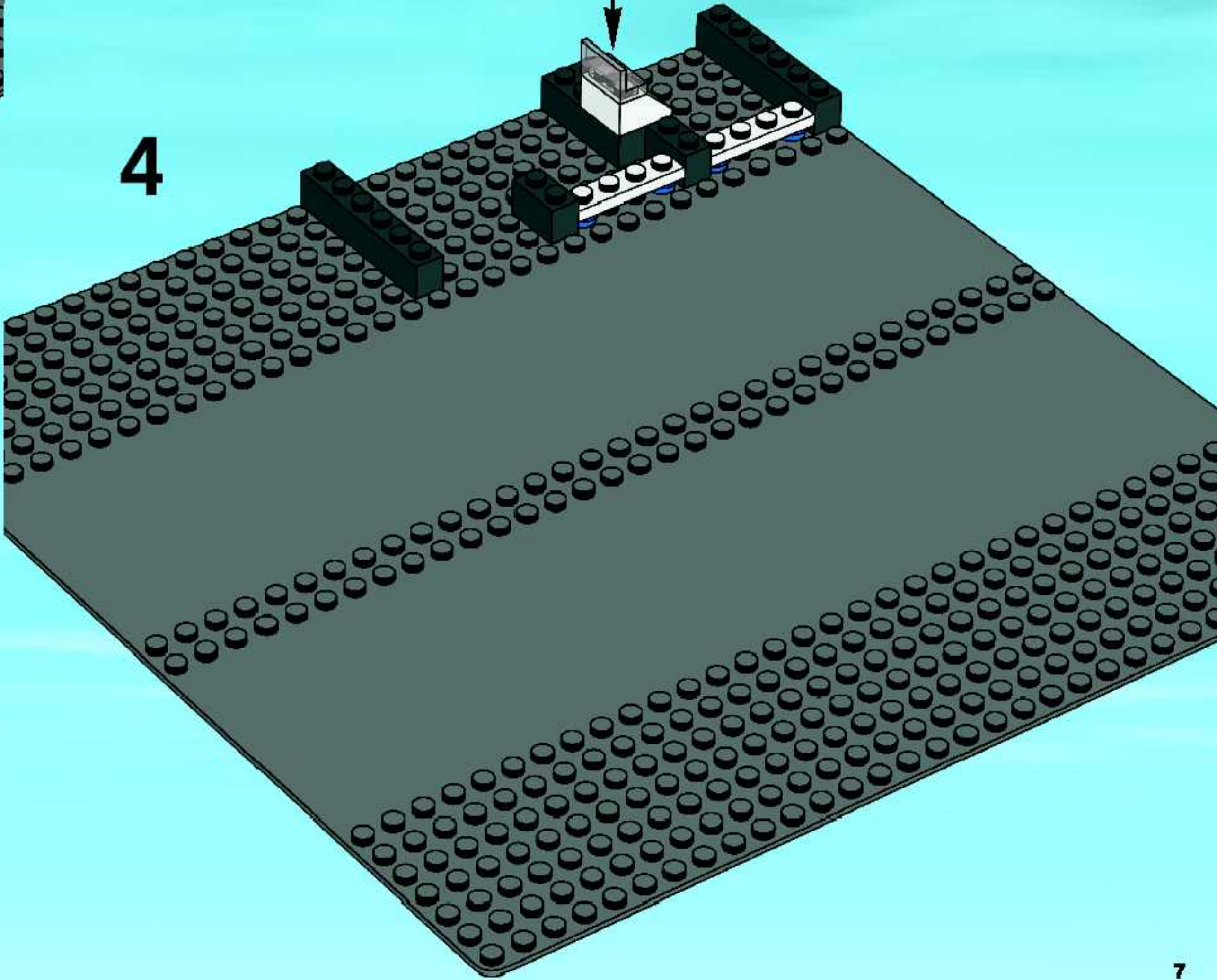



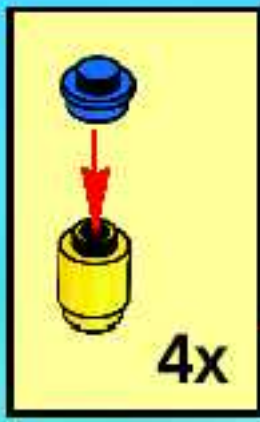

5

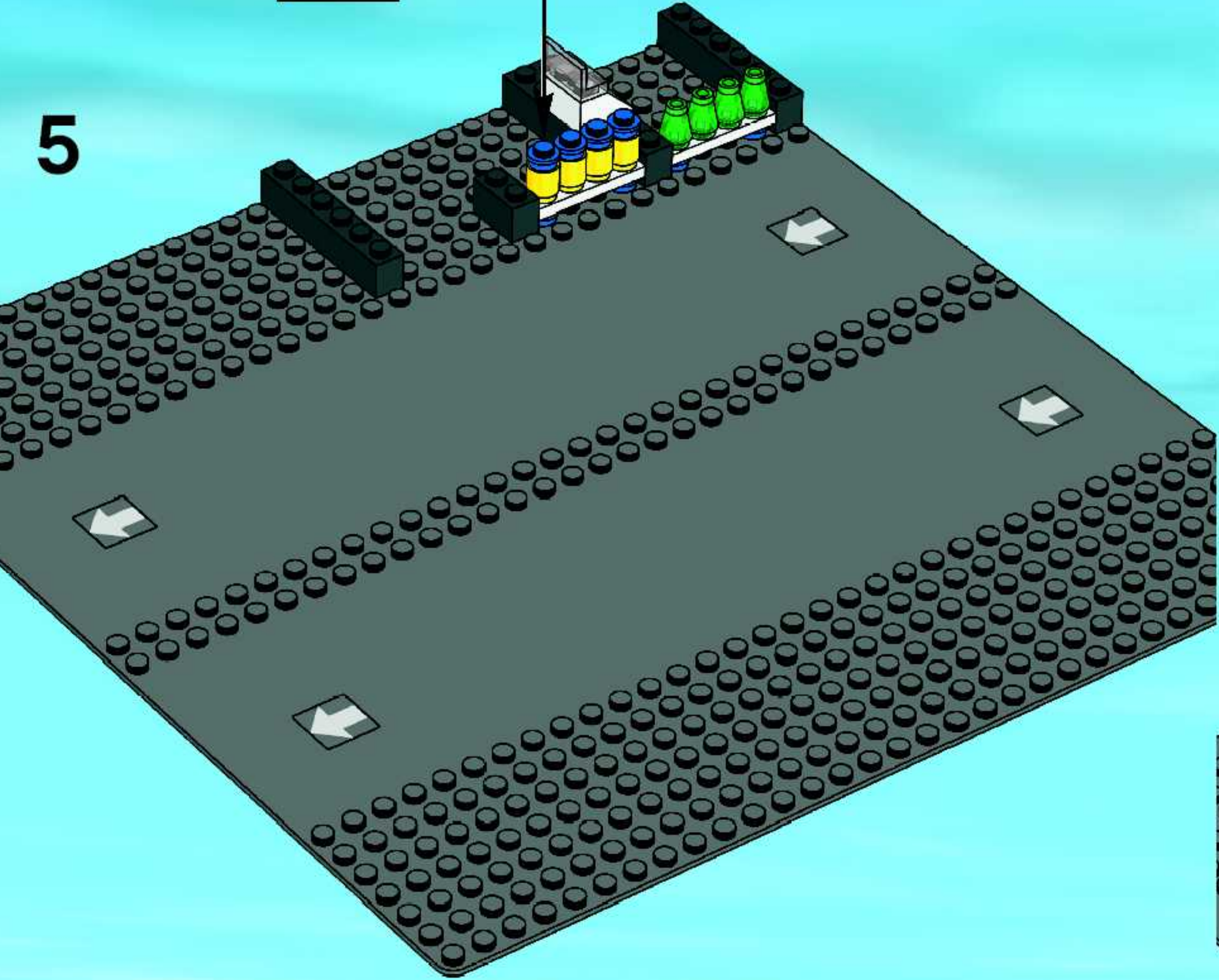



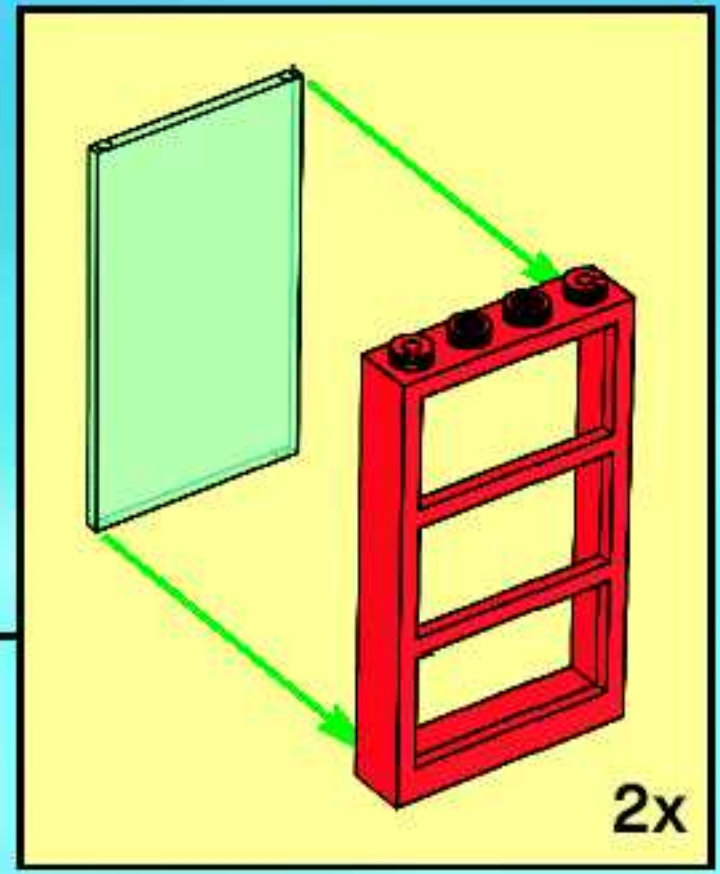
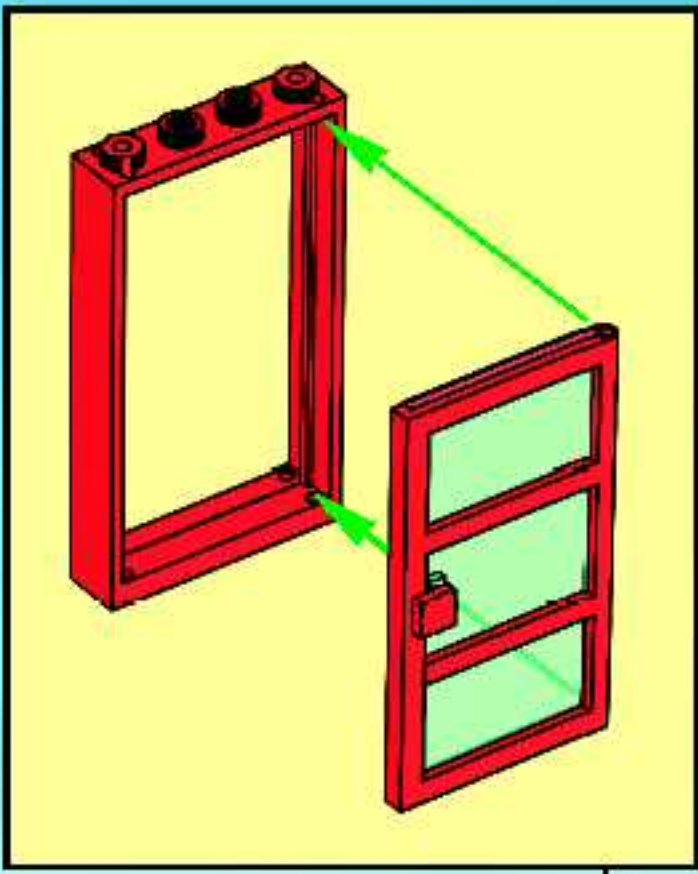

6

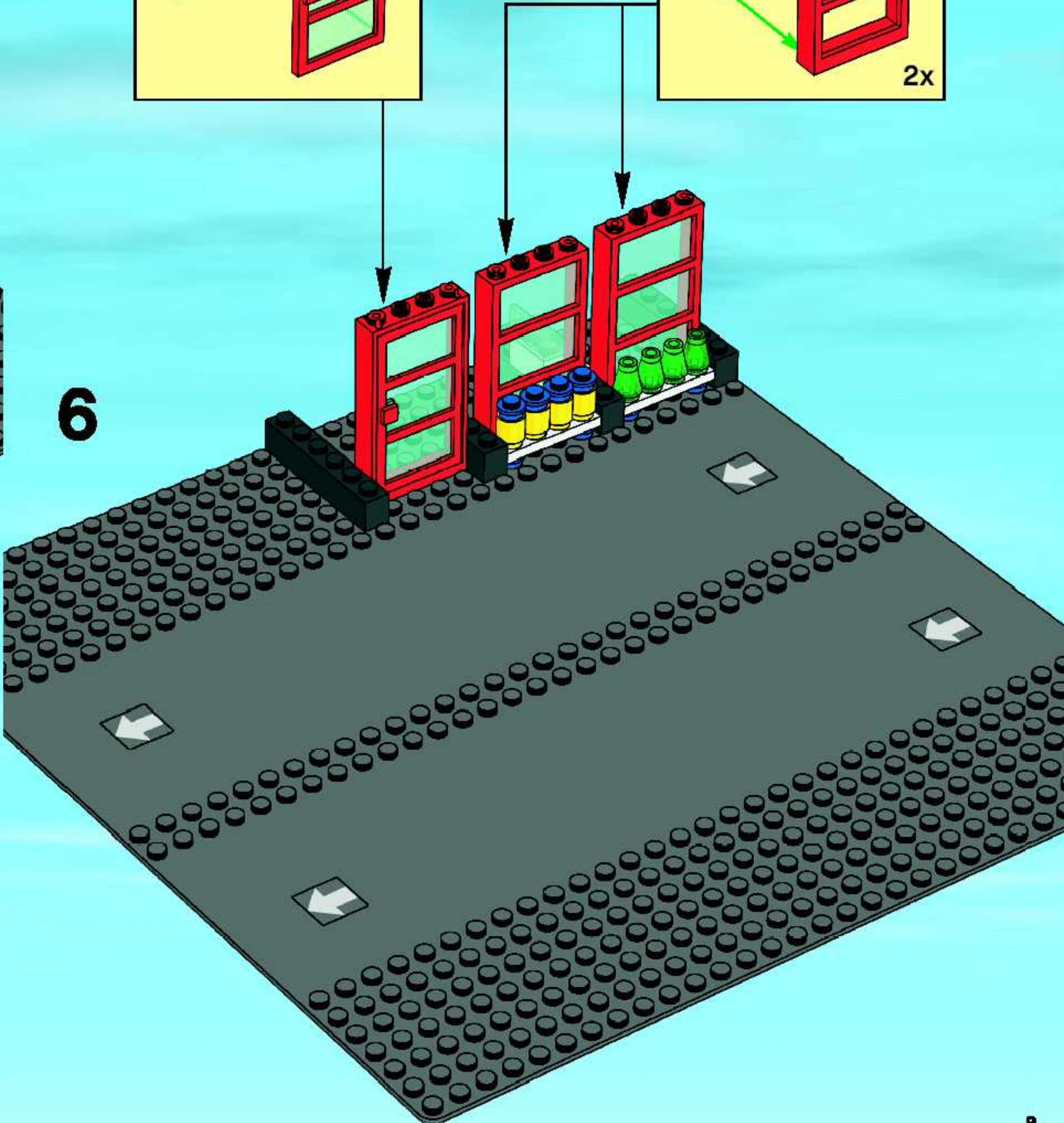



7

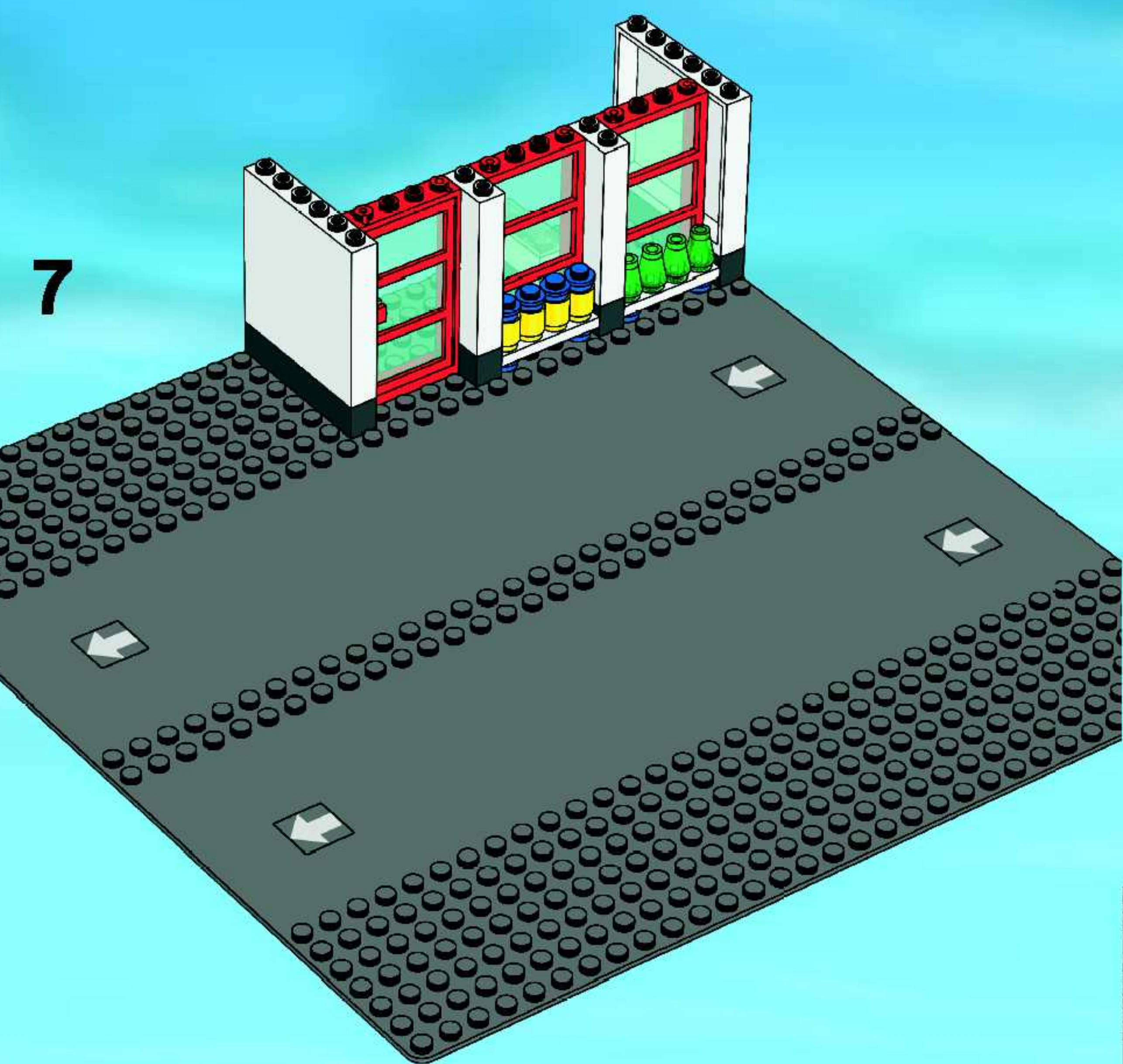



8

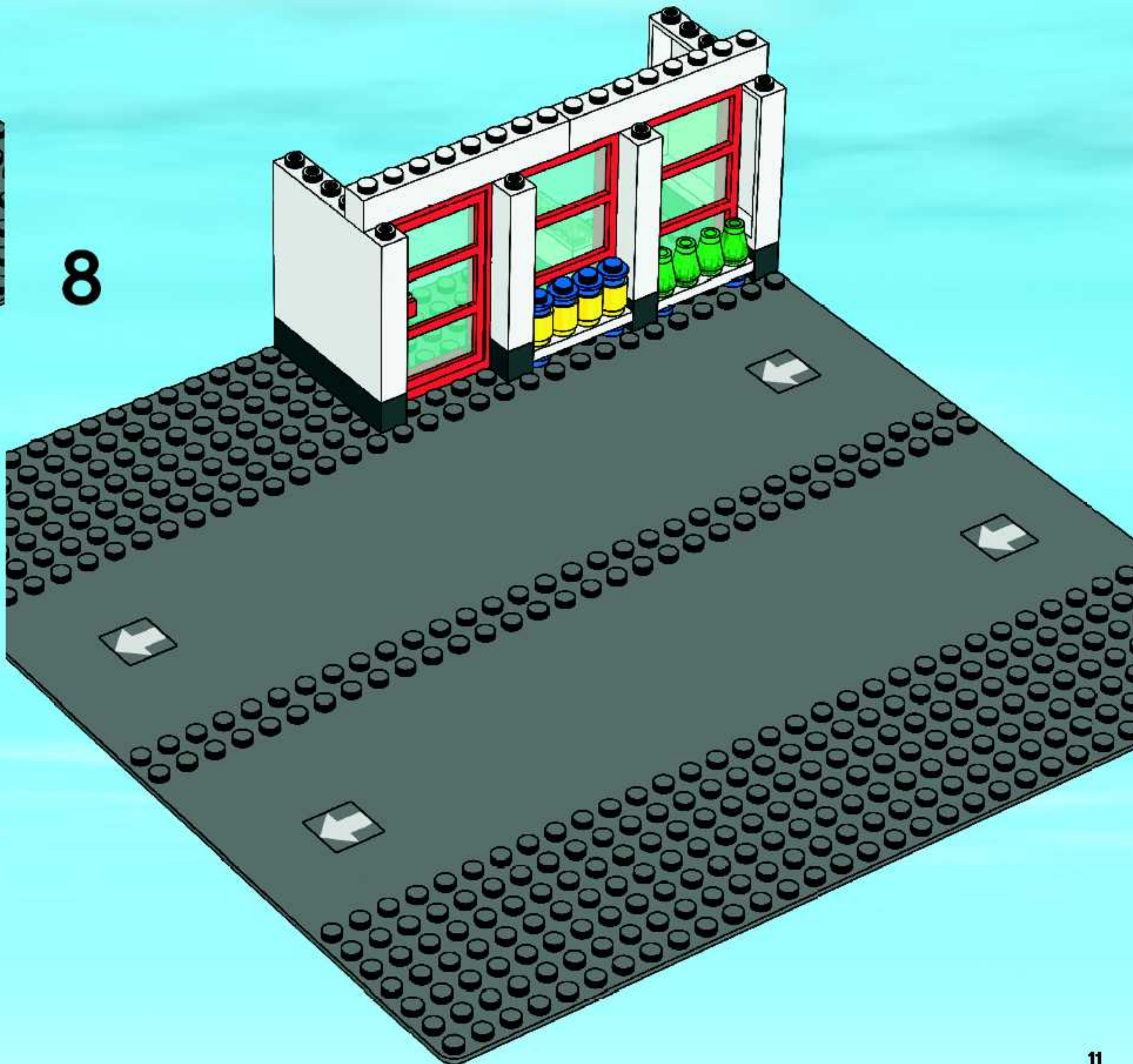



9

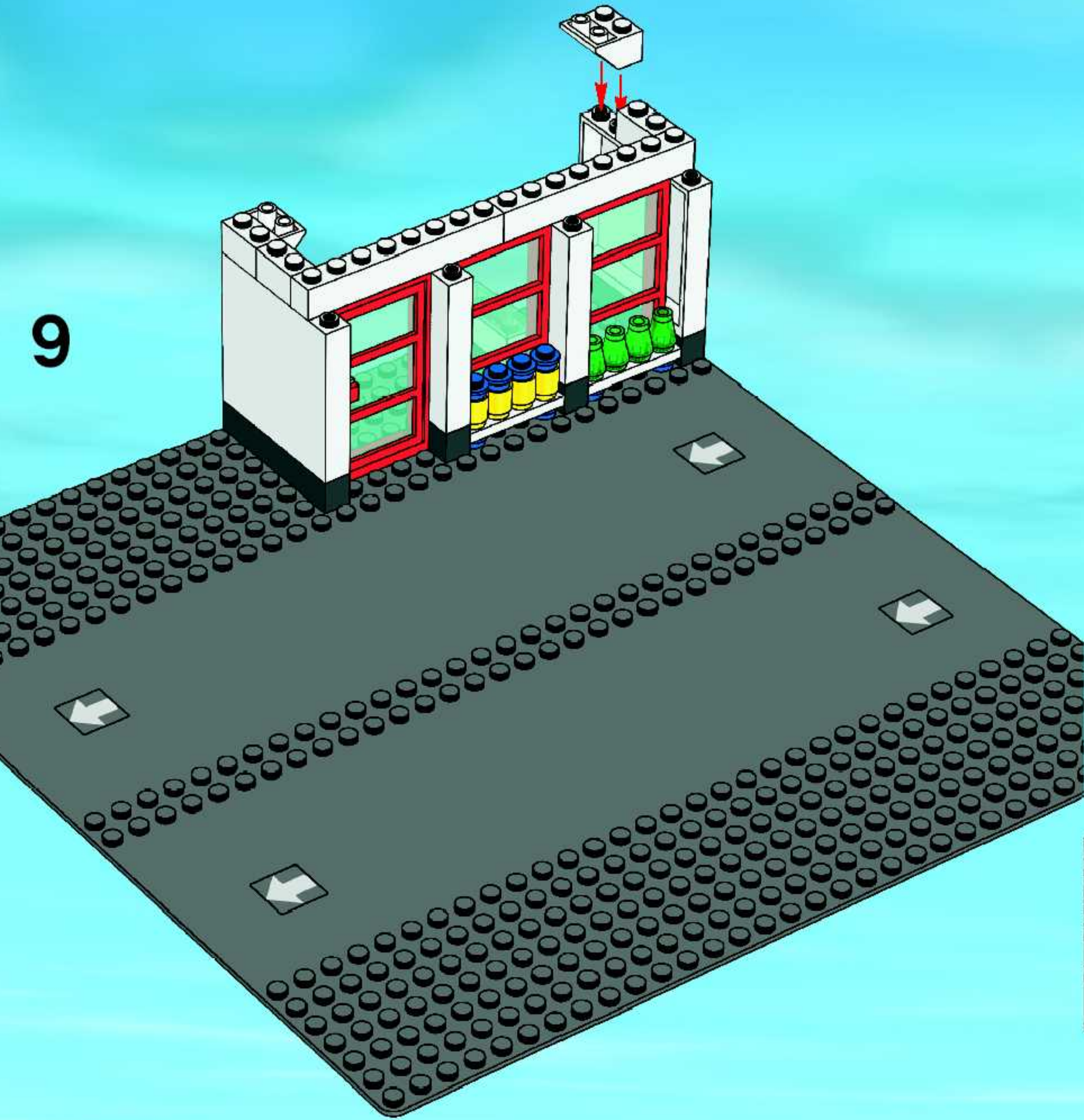



10

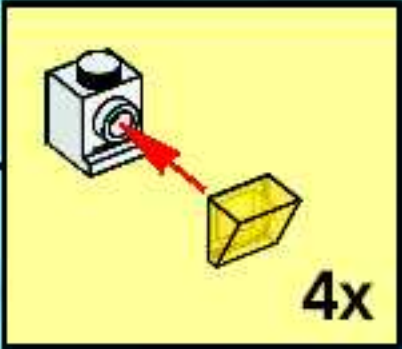
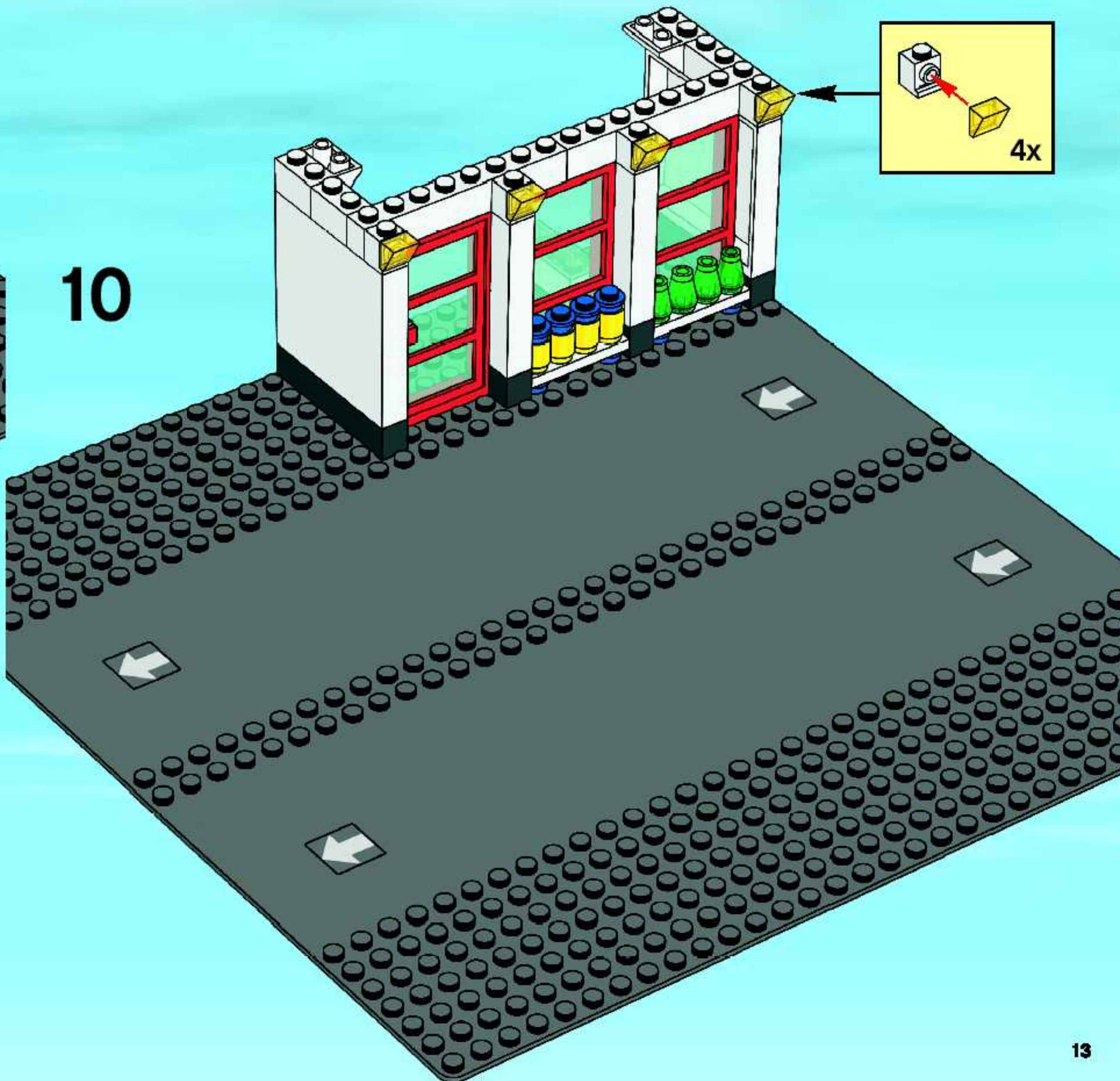



11

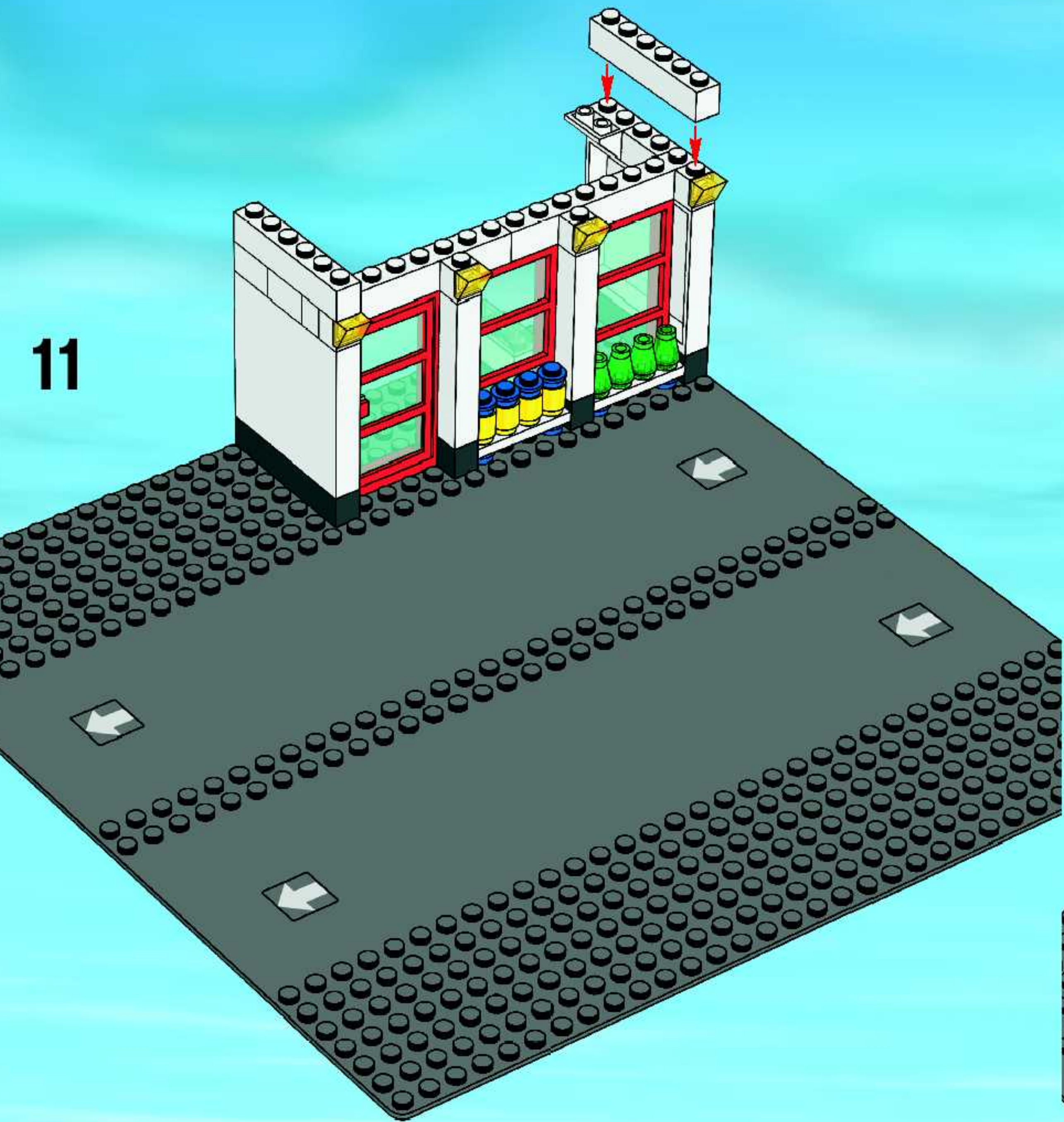



1

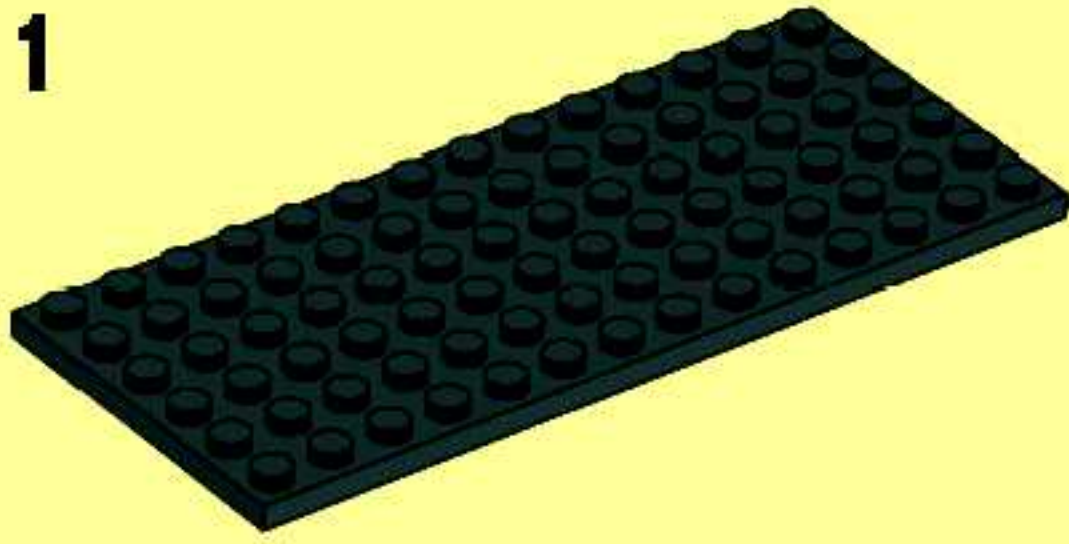

2

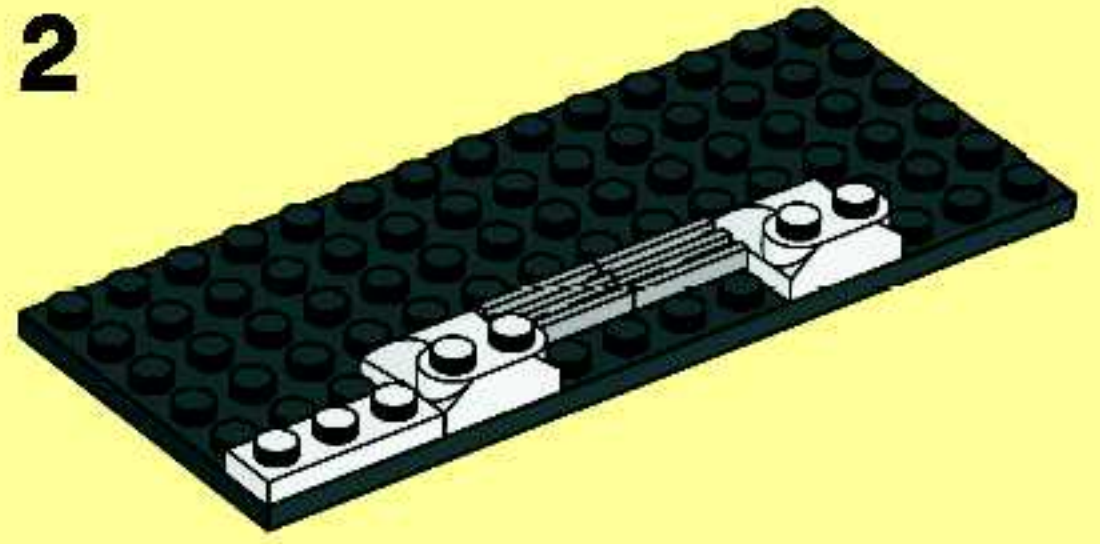

12

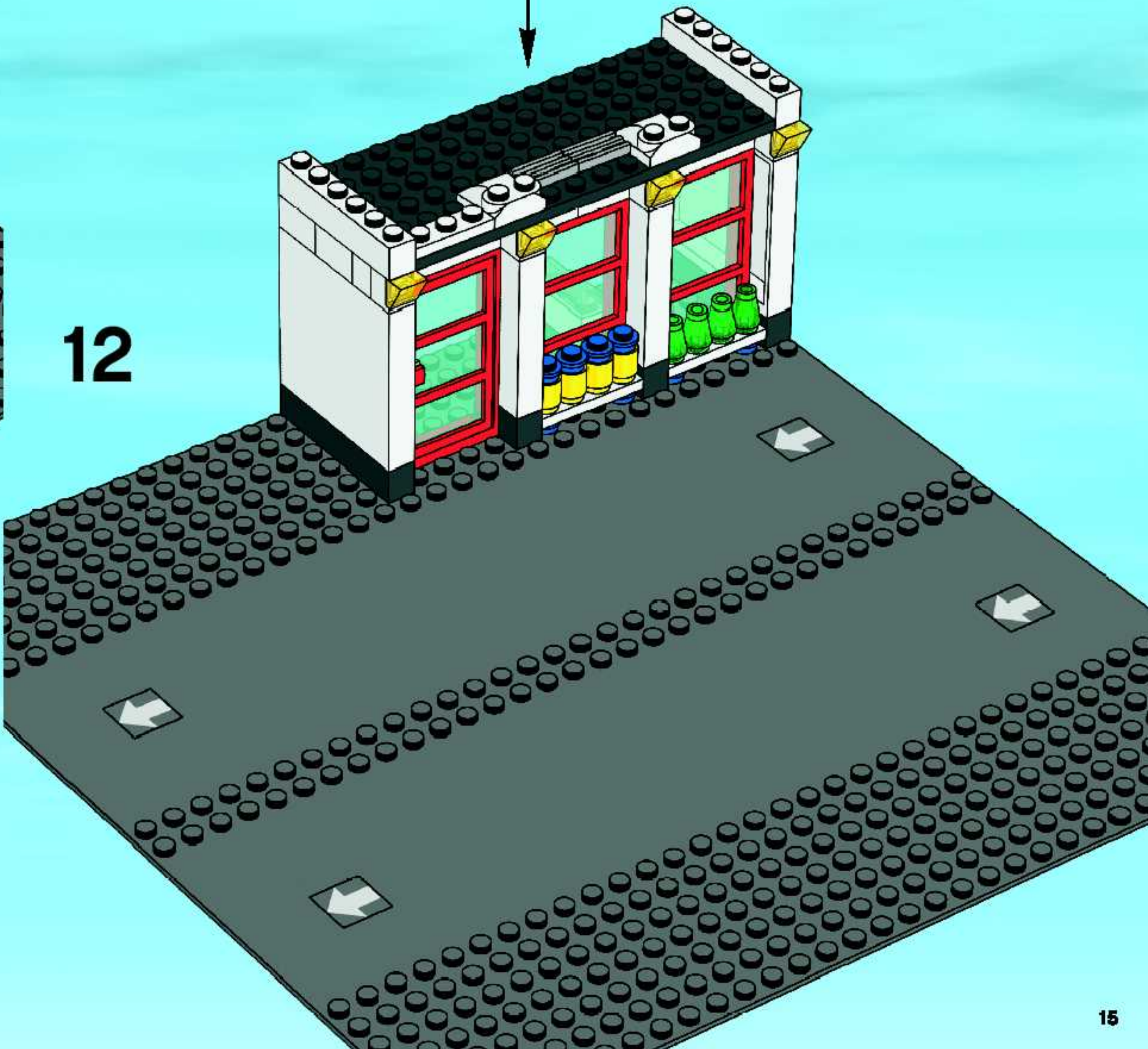



13

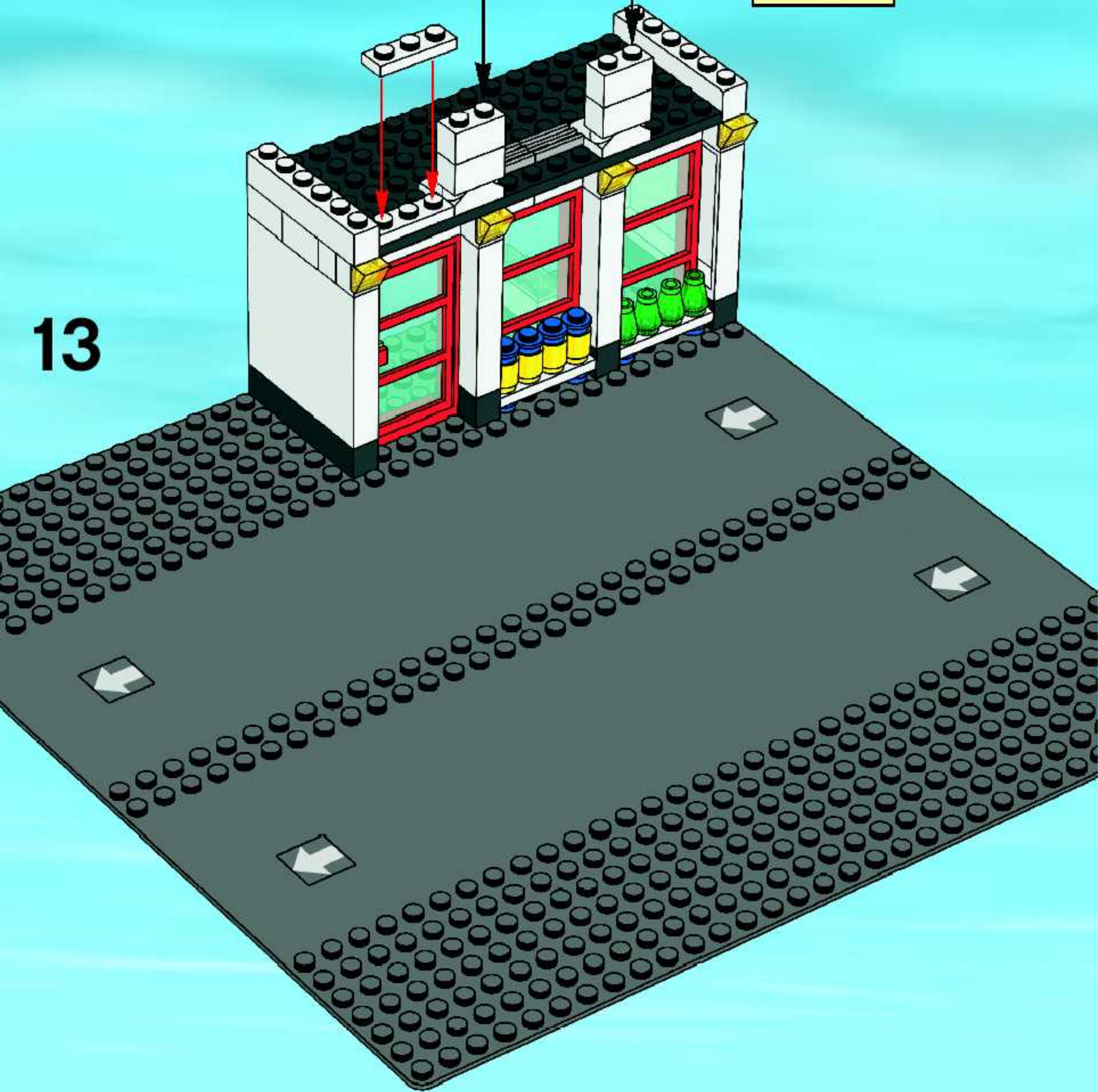
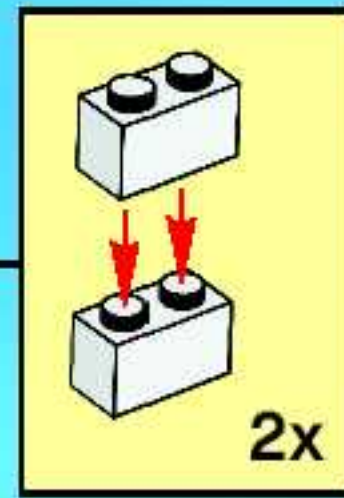



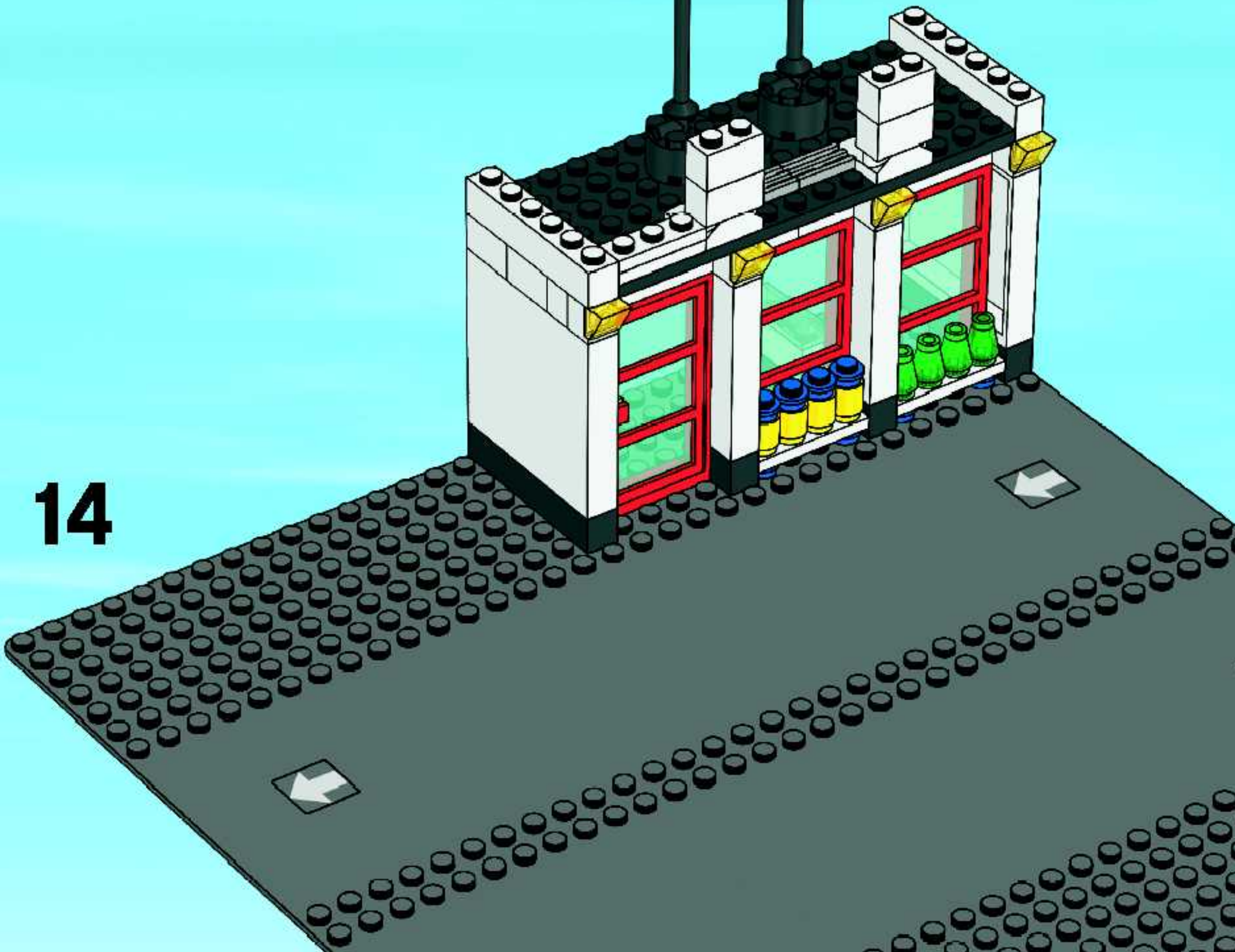
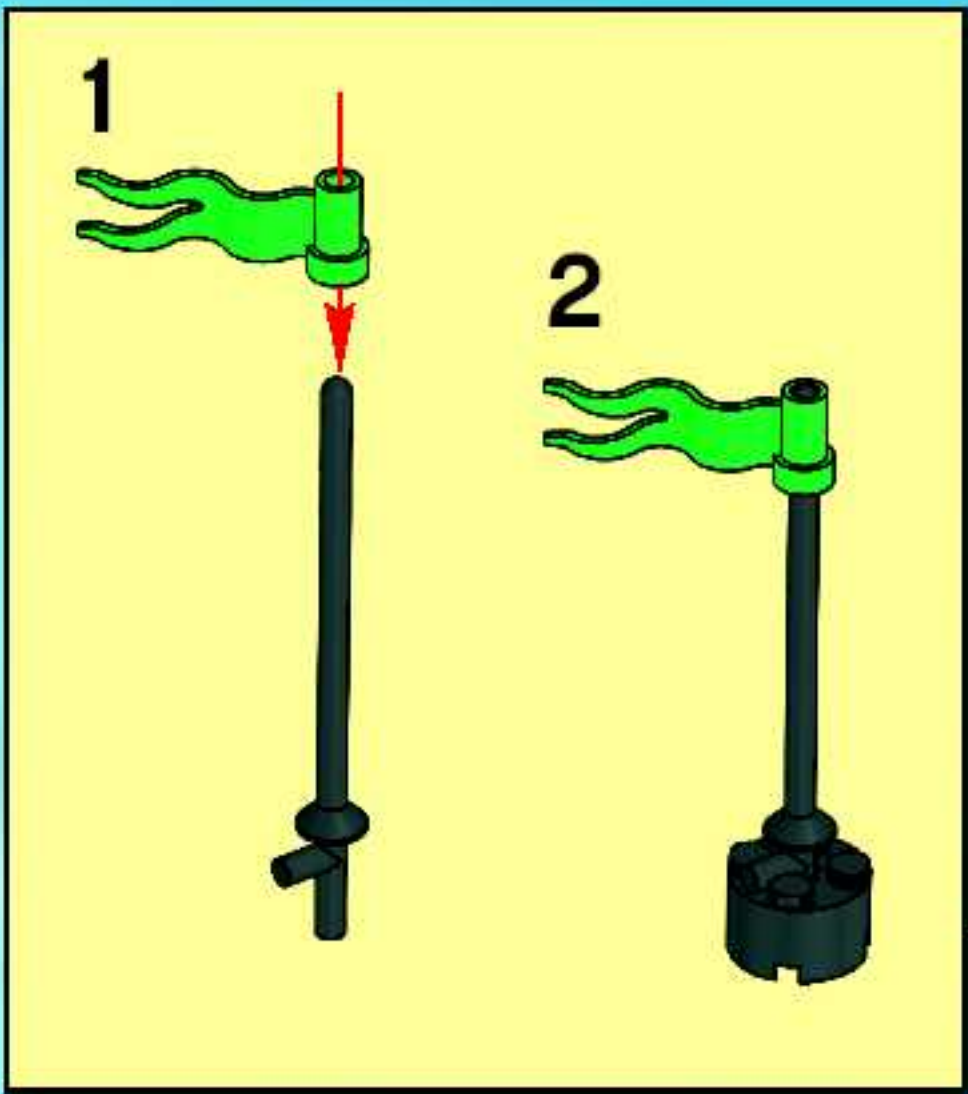

14



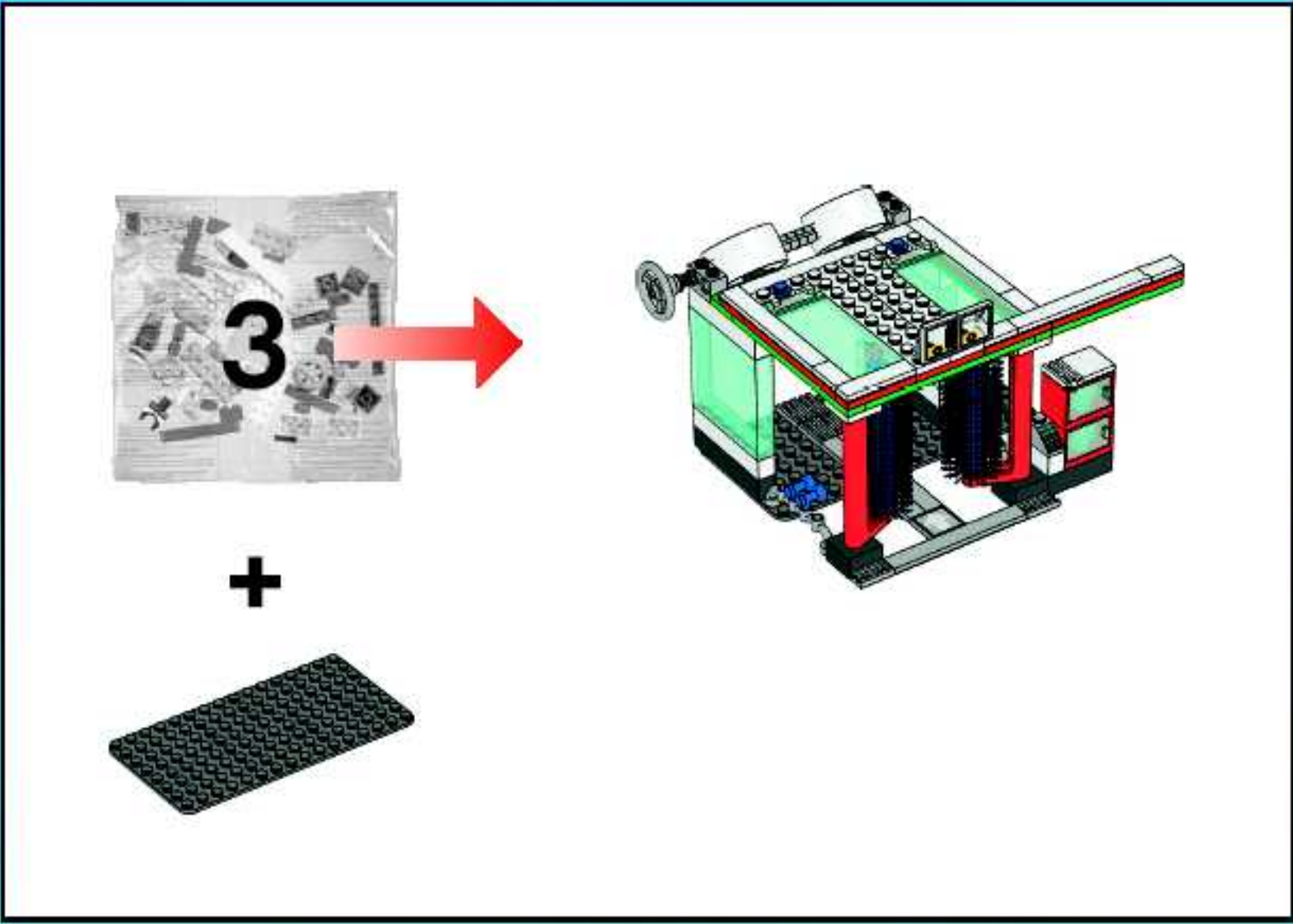

1

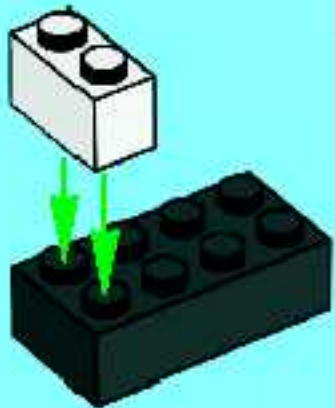

2

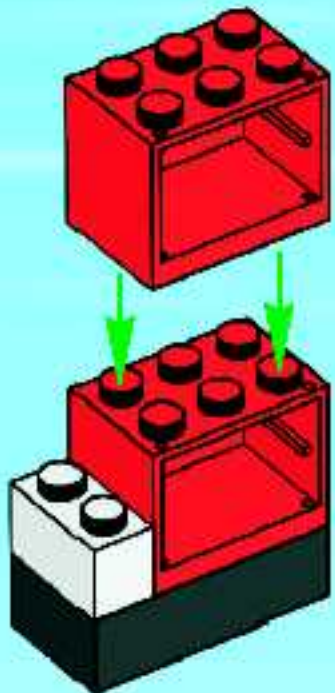

3

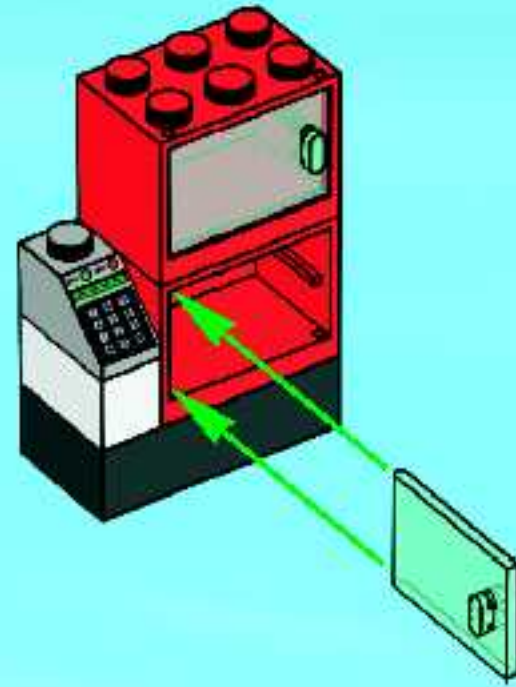

4

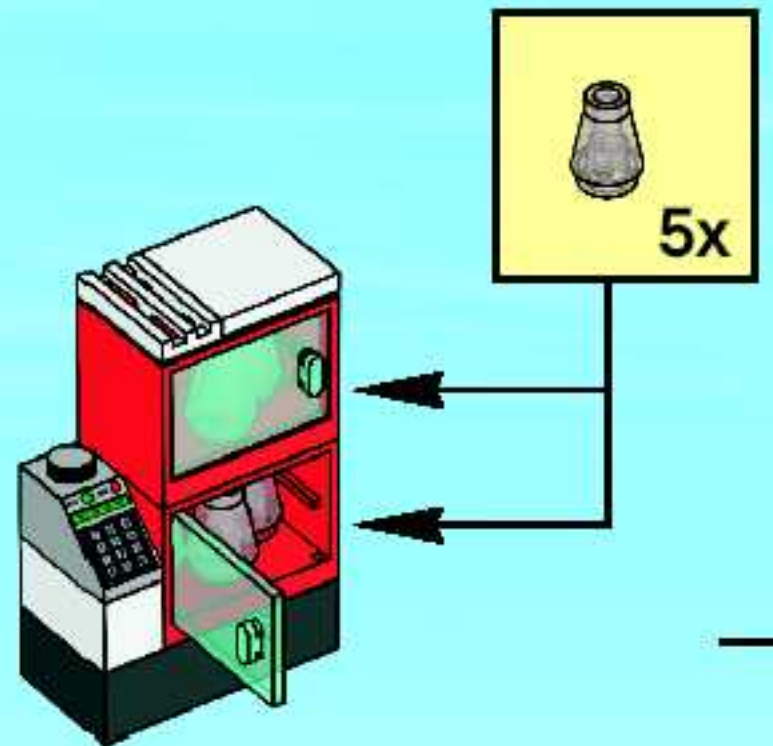



15

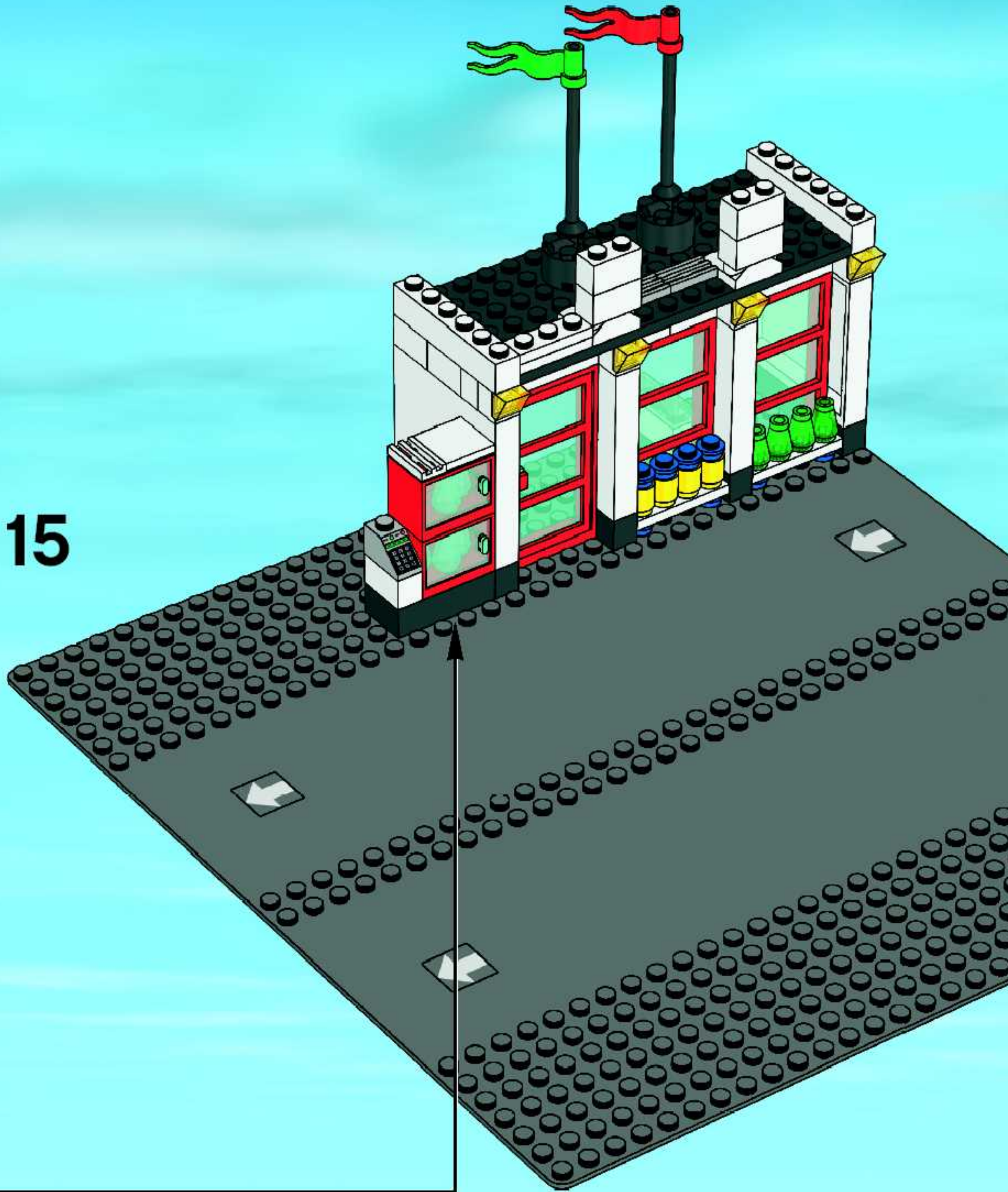



16

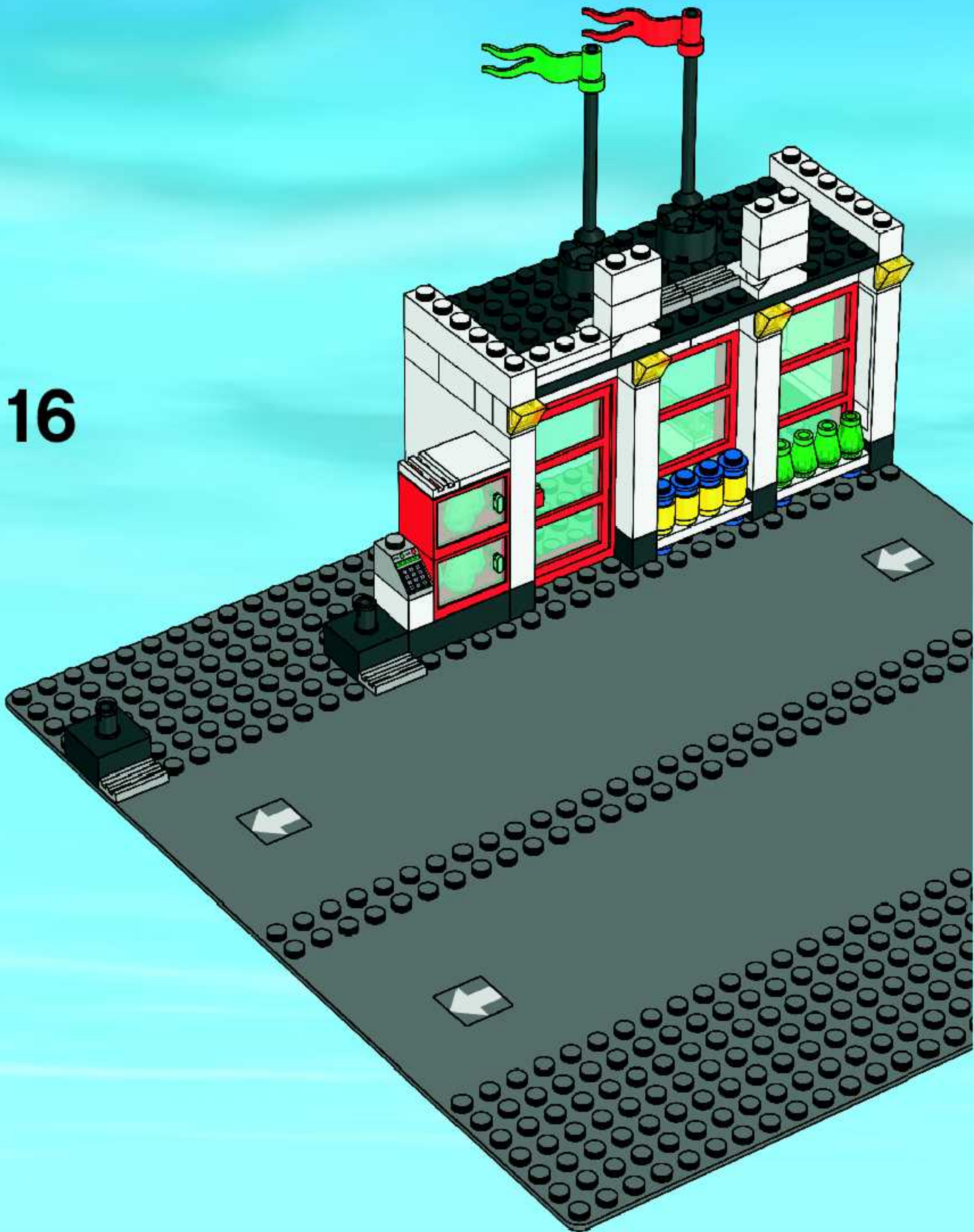



17

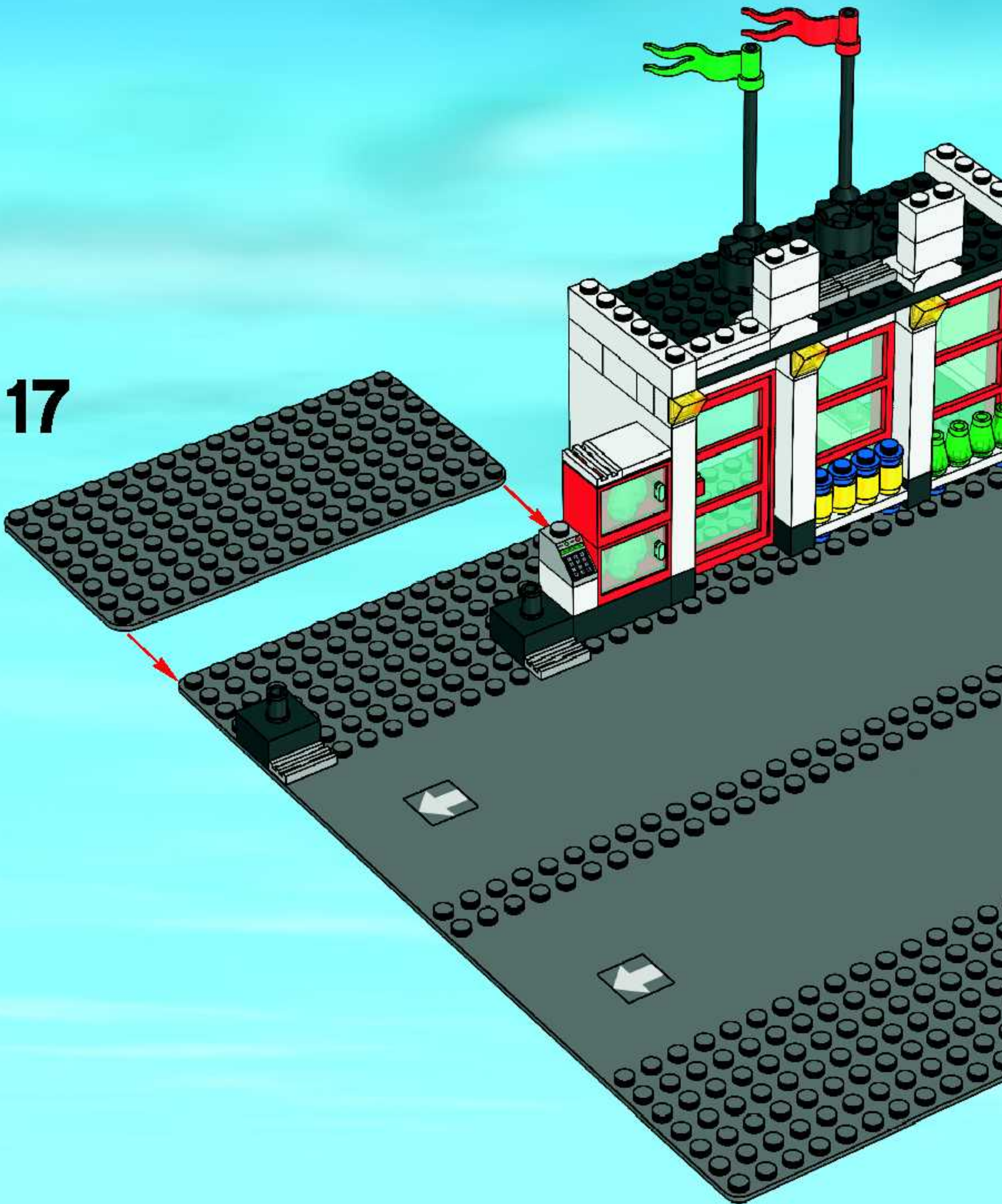



18

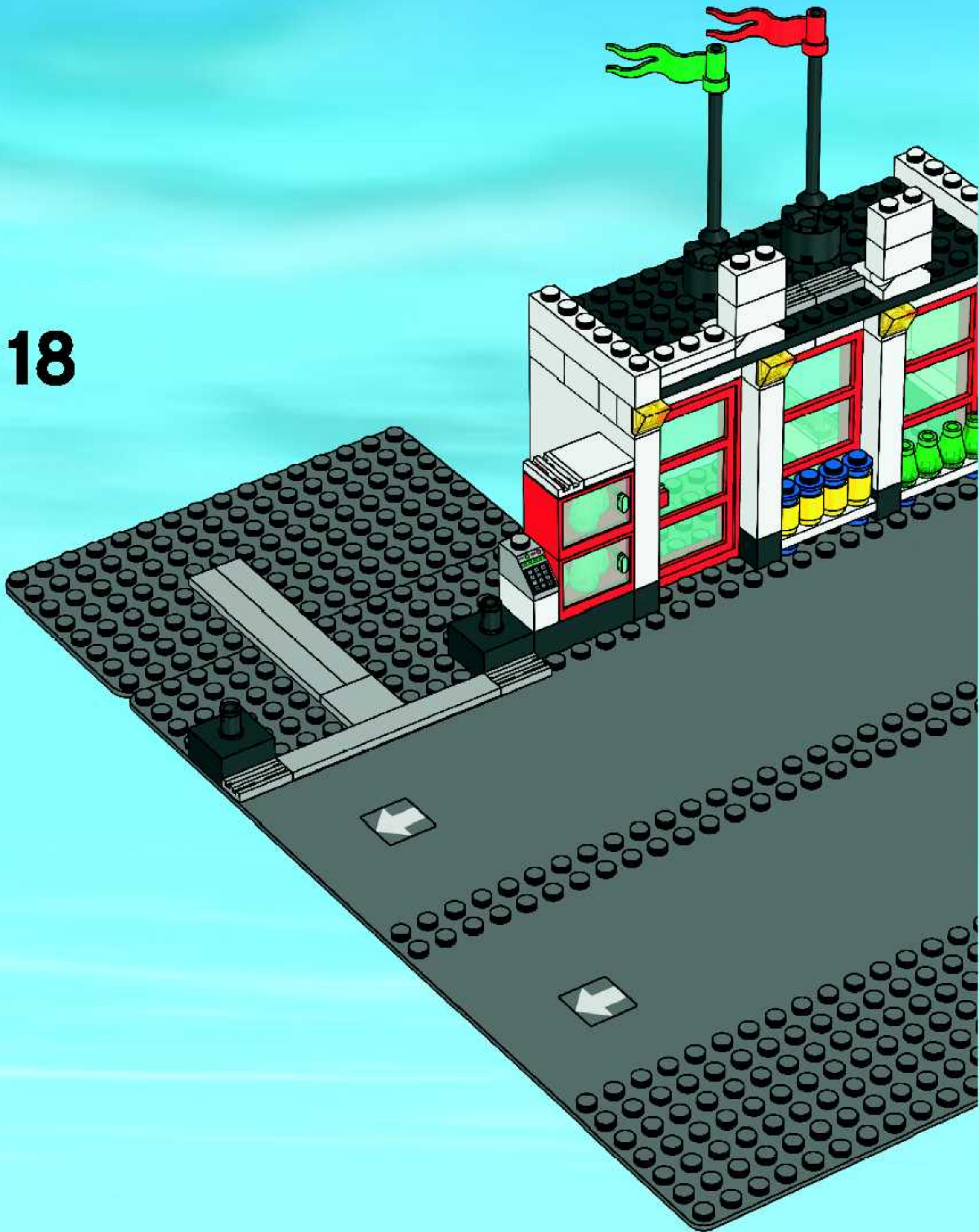



19

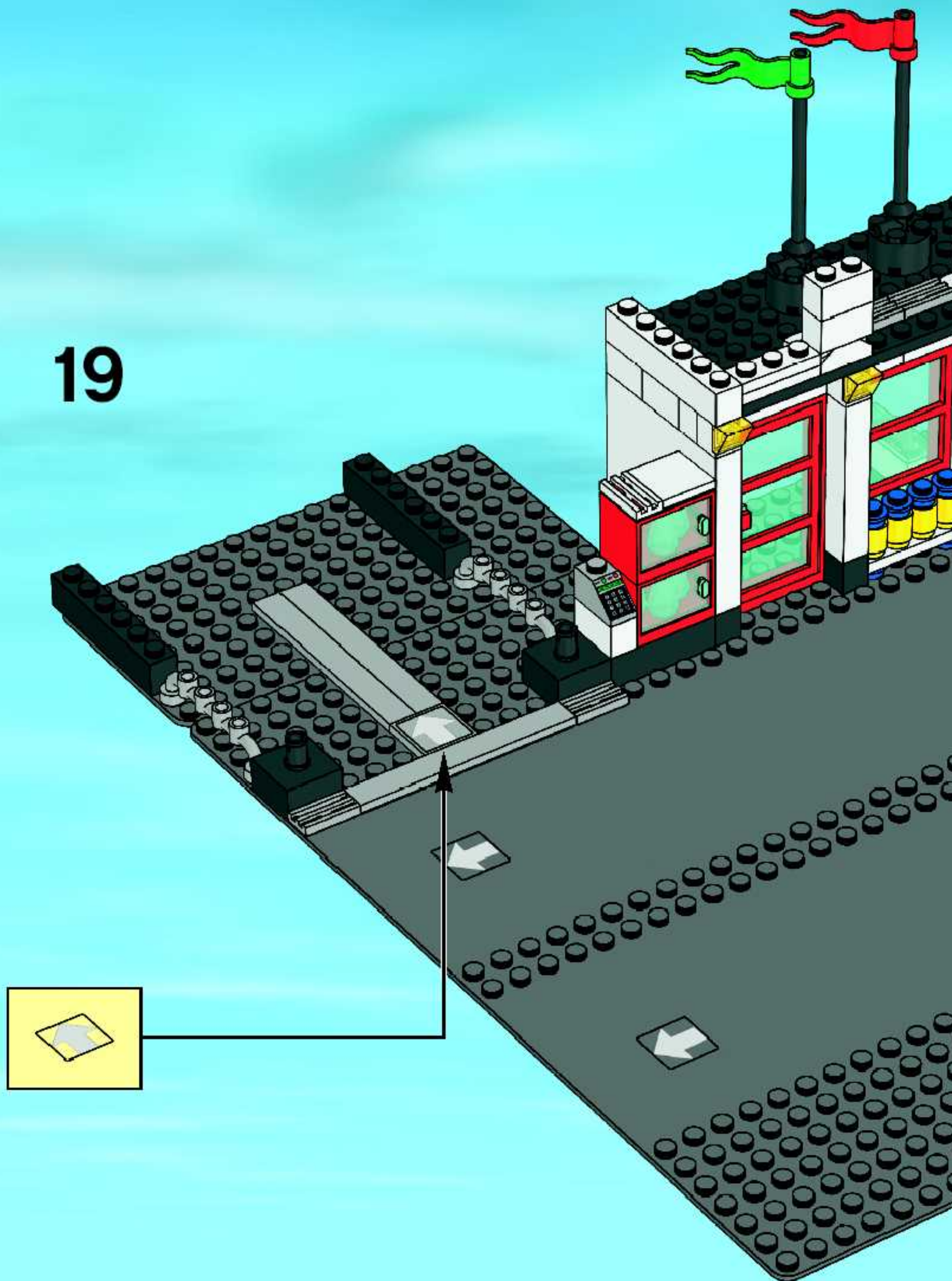



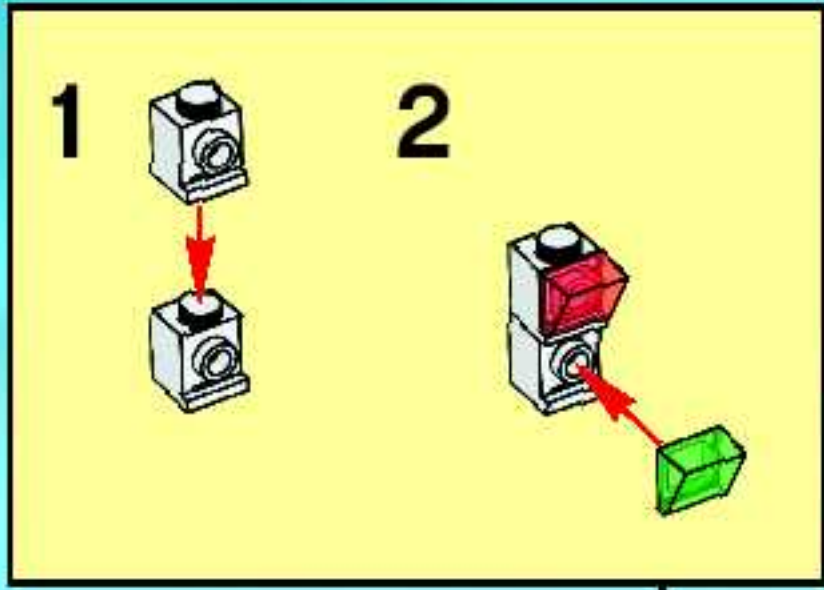

20

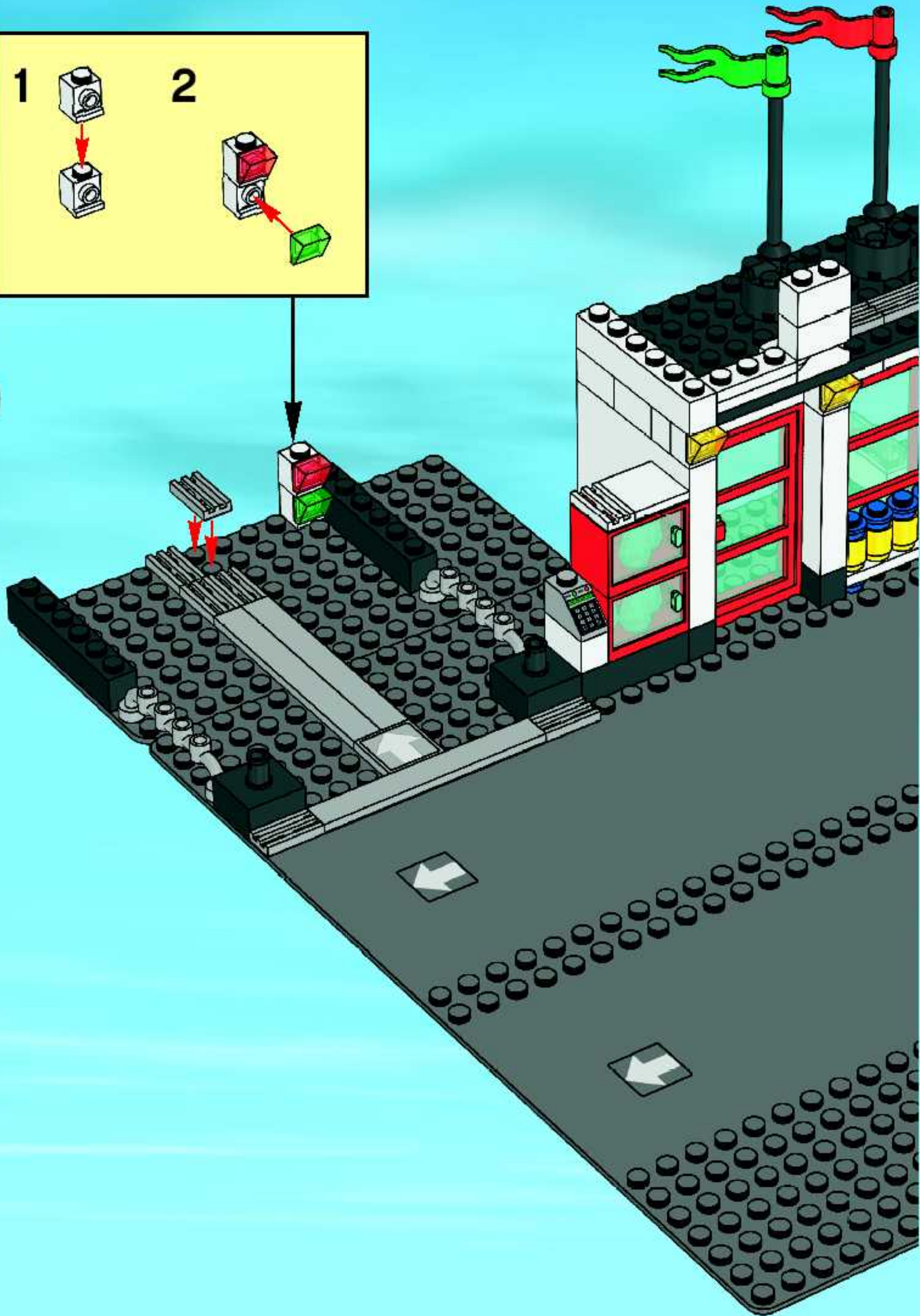



21

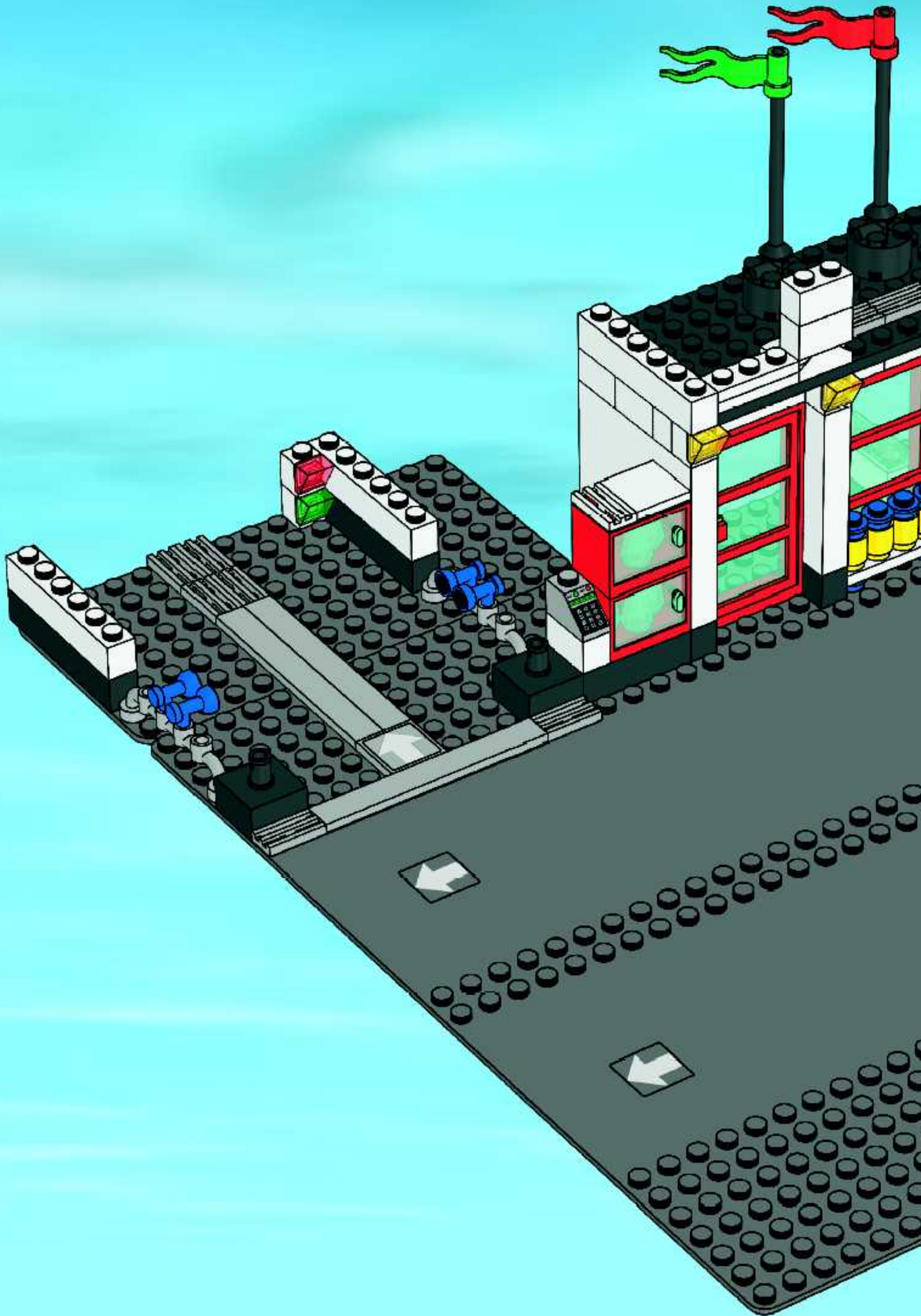



22

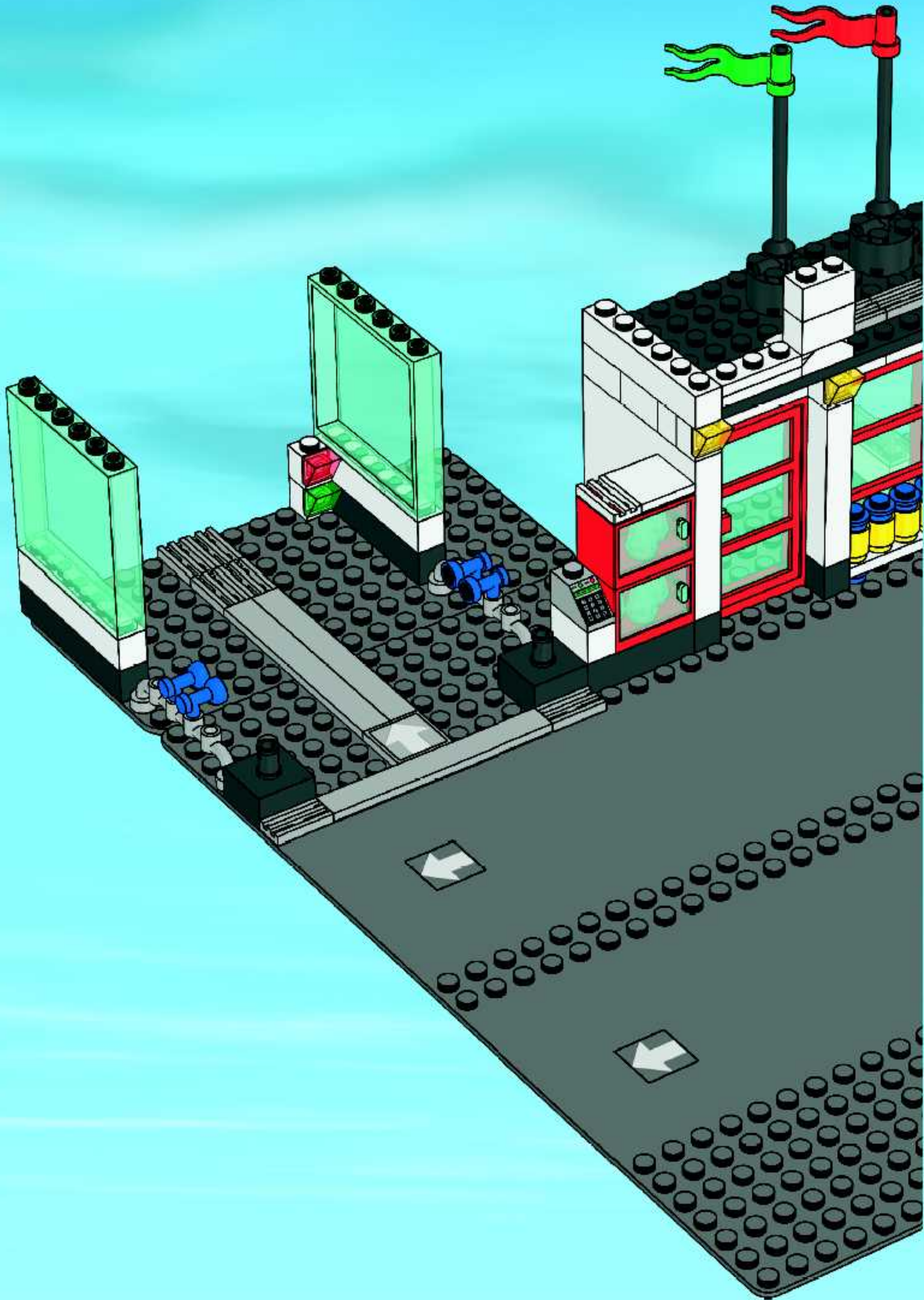



23

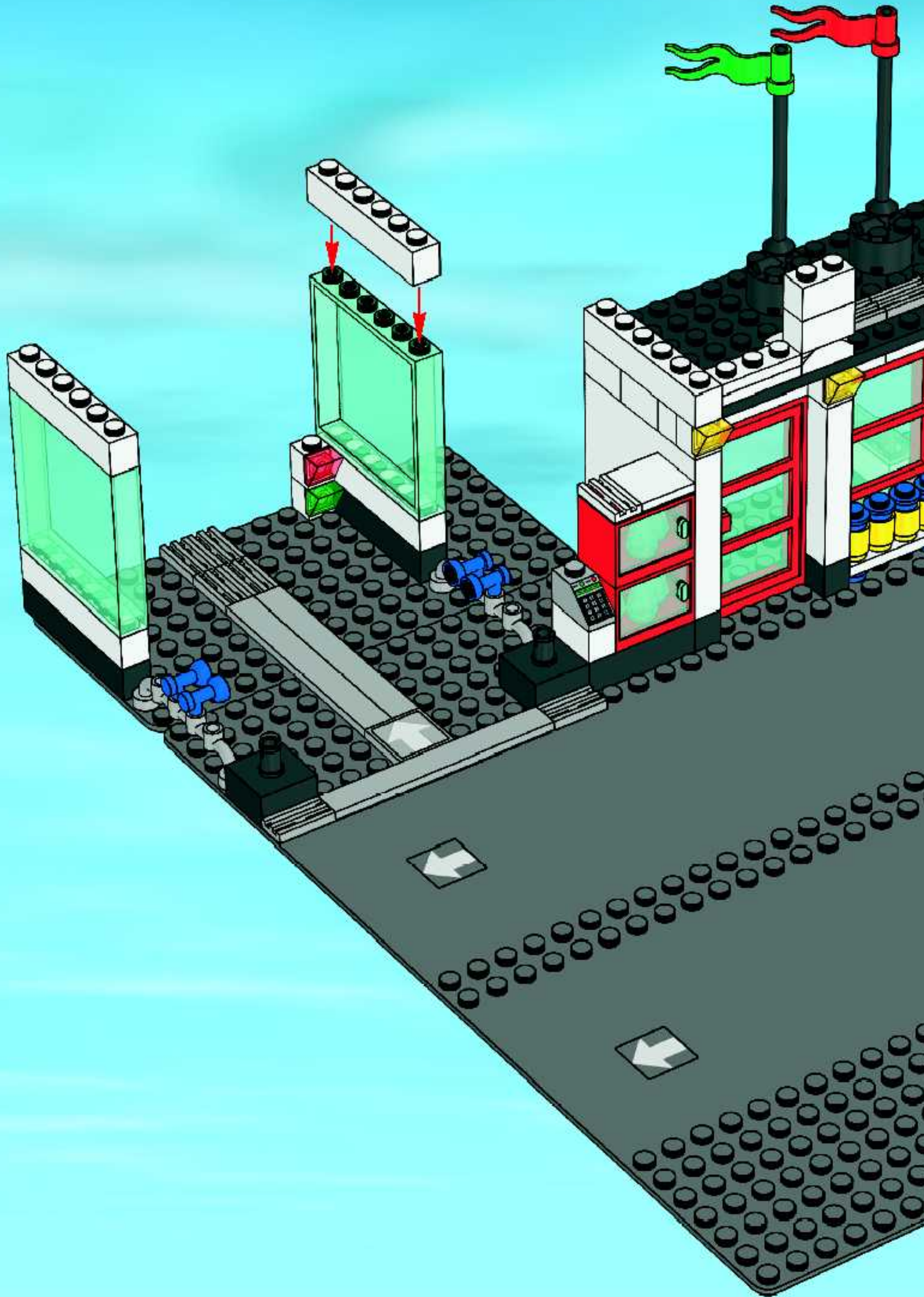



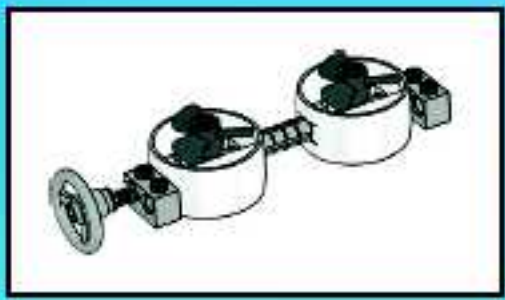

1

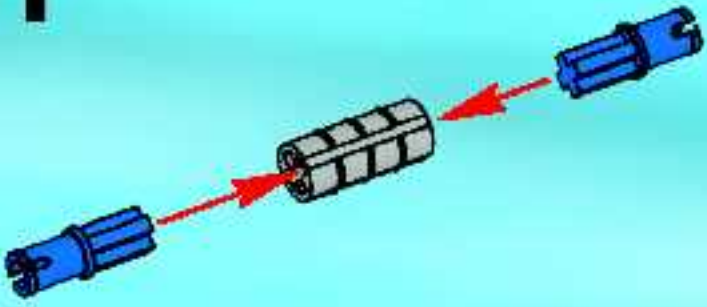

2

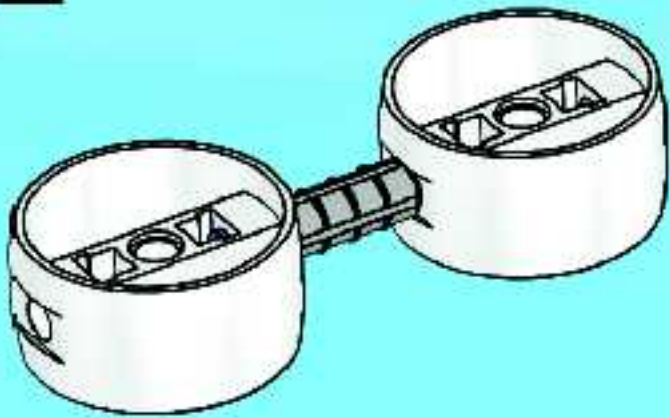

3

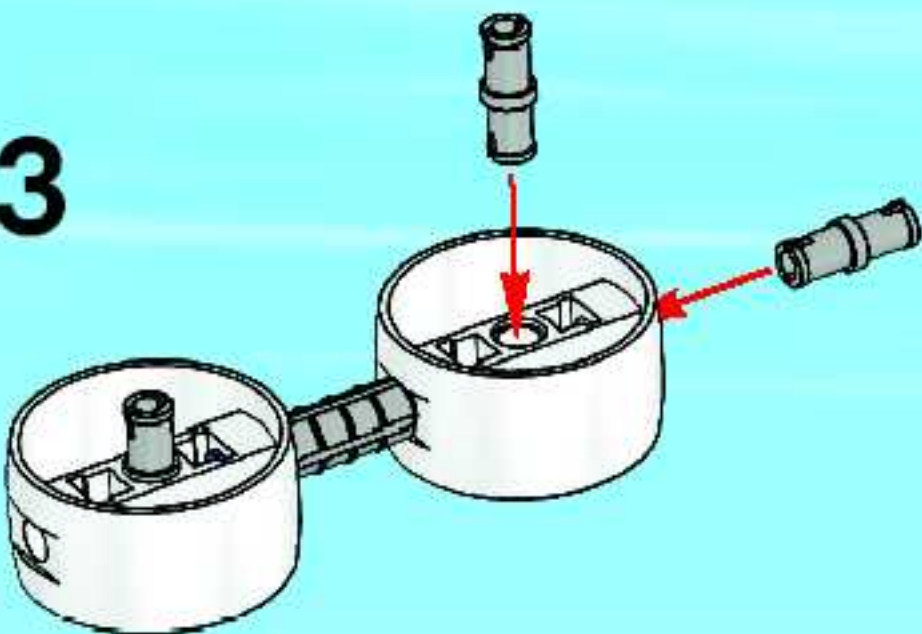

4



1

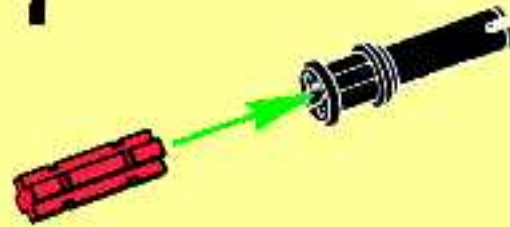

2



3

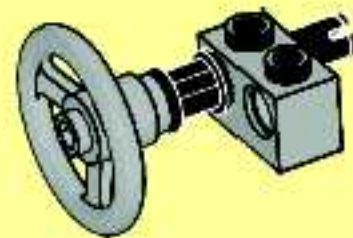

5

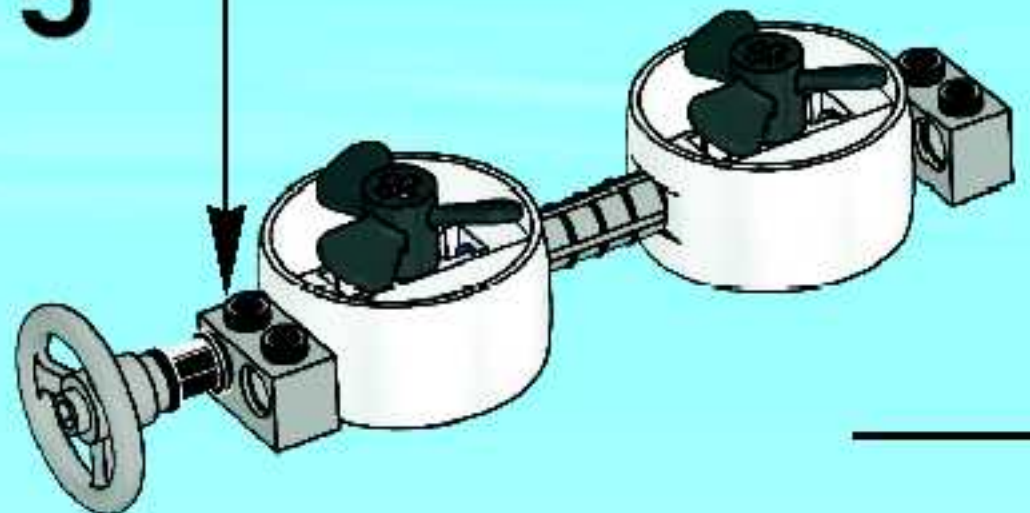



24

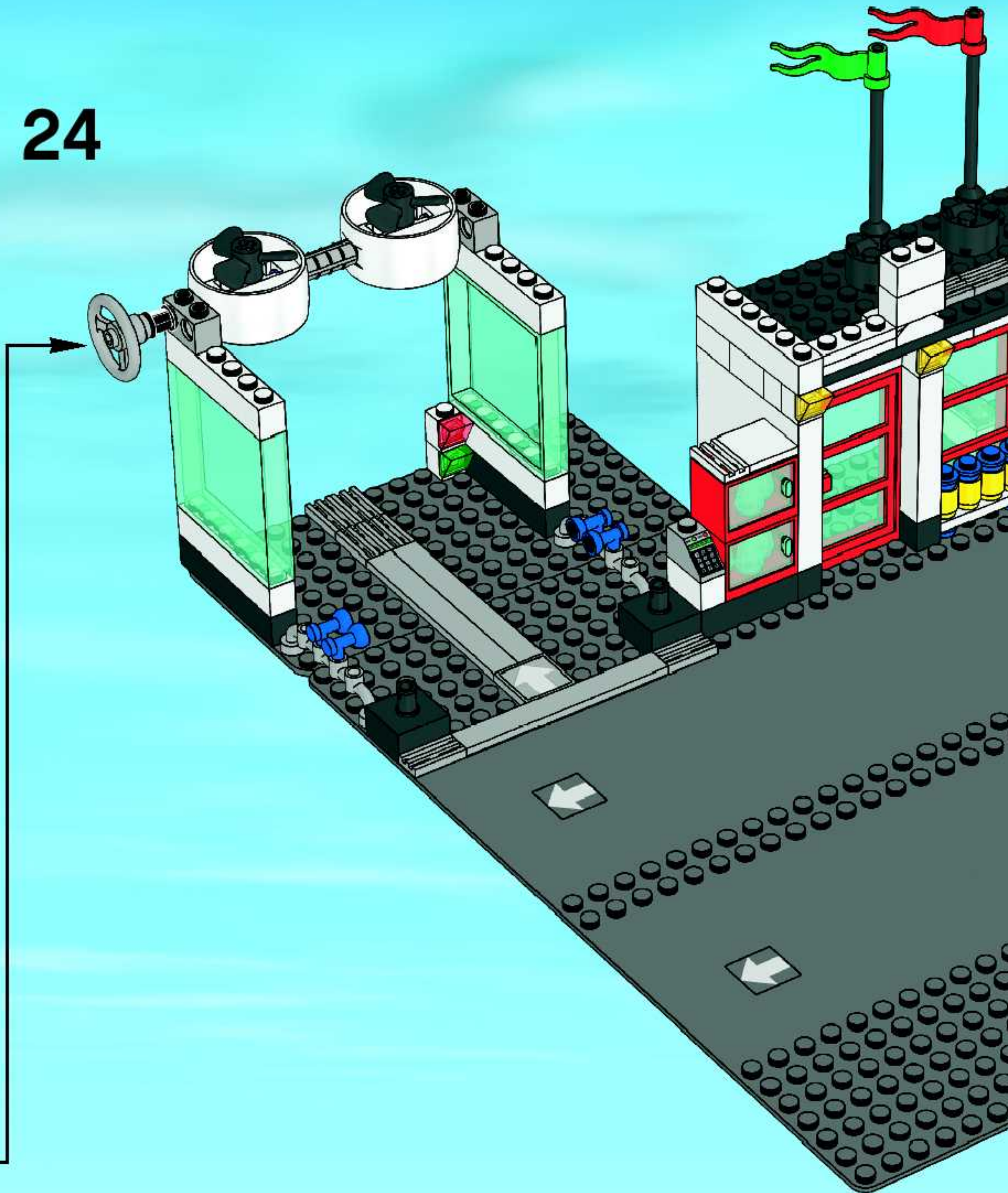





1



2



3

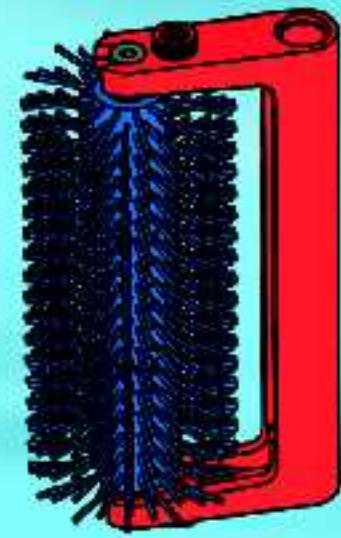

4

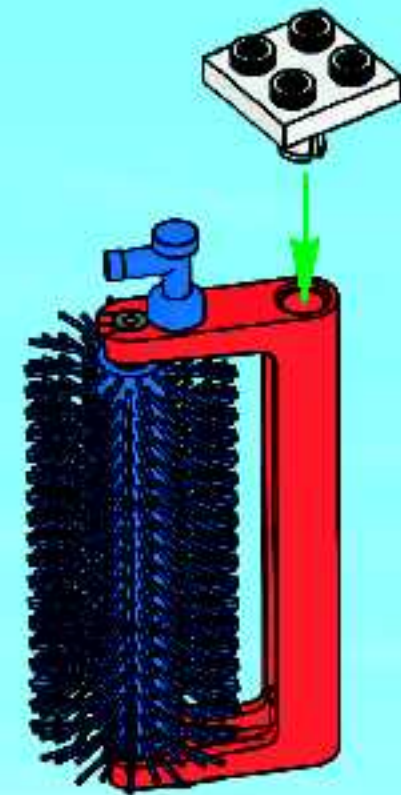

2x



25

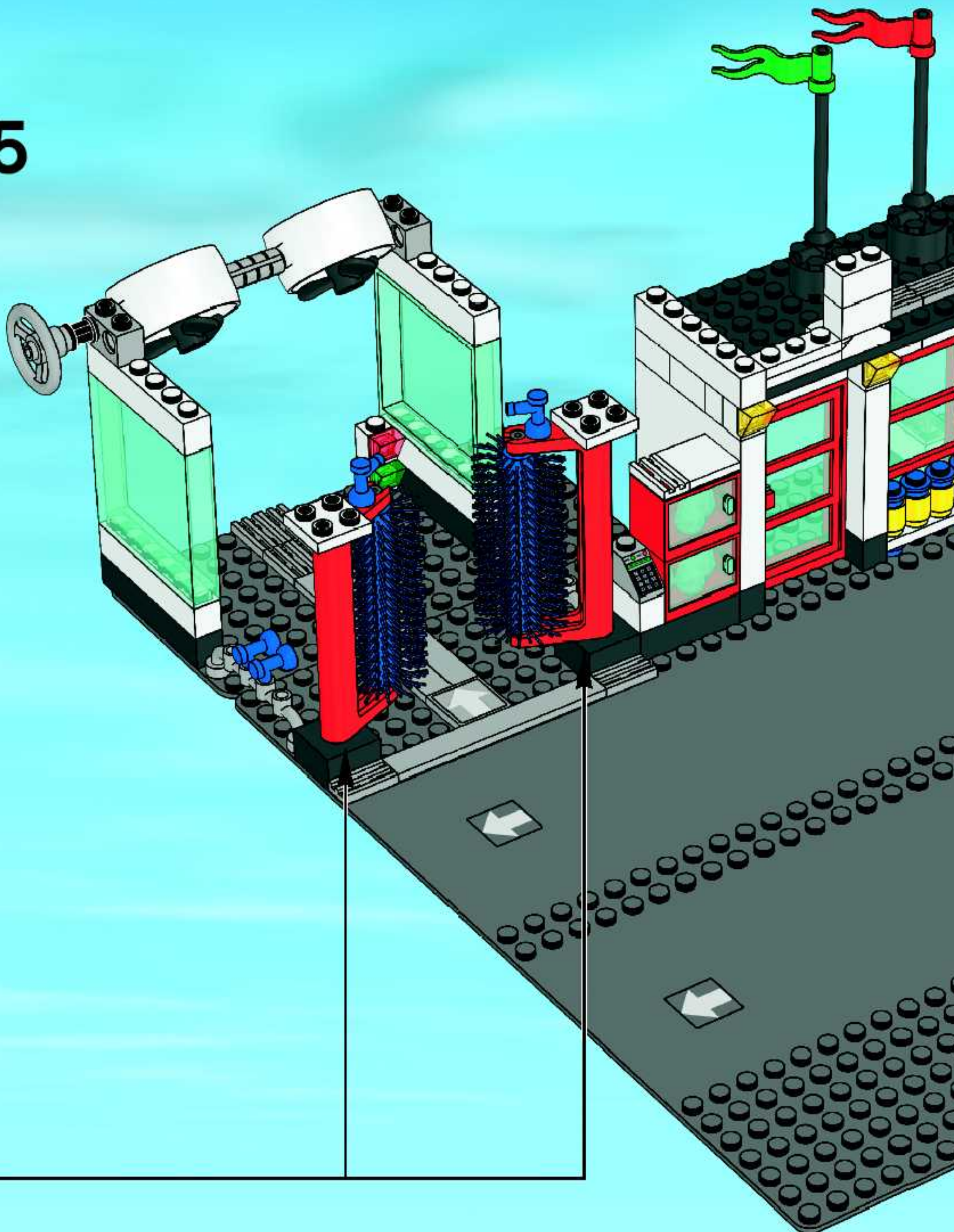



26

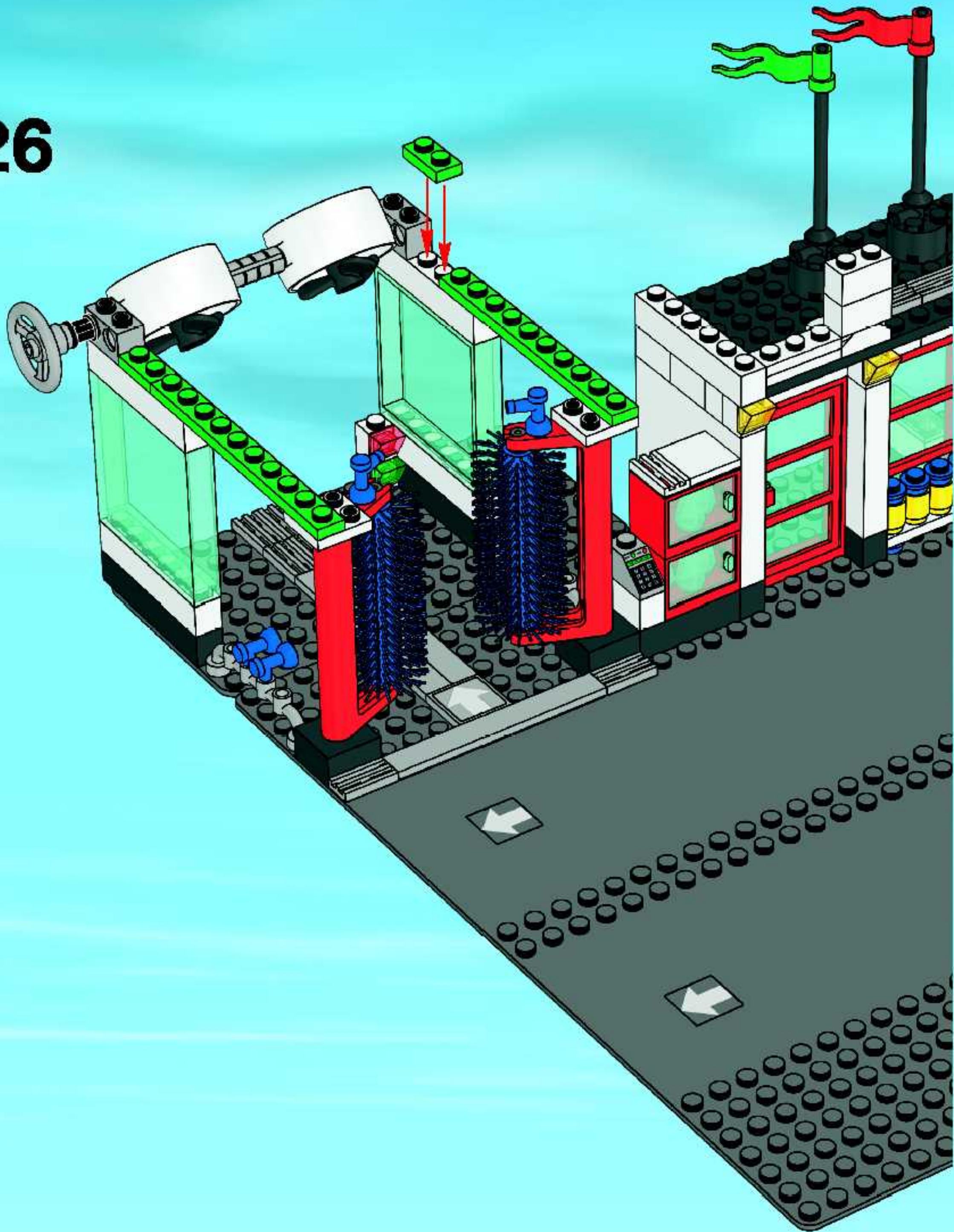



27

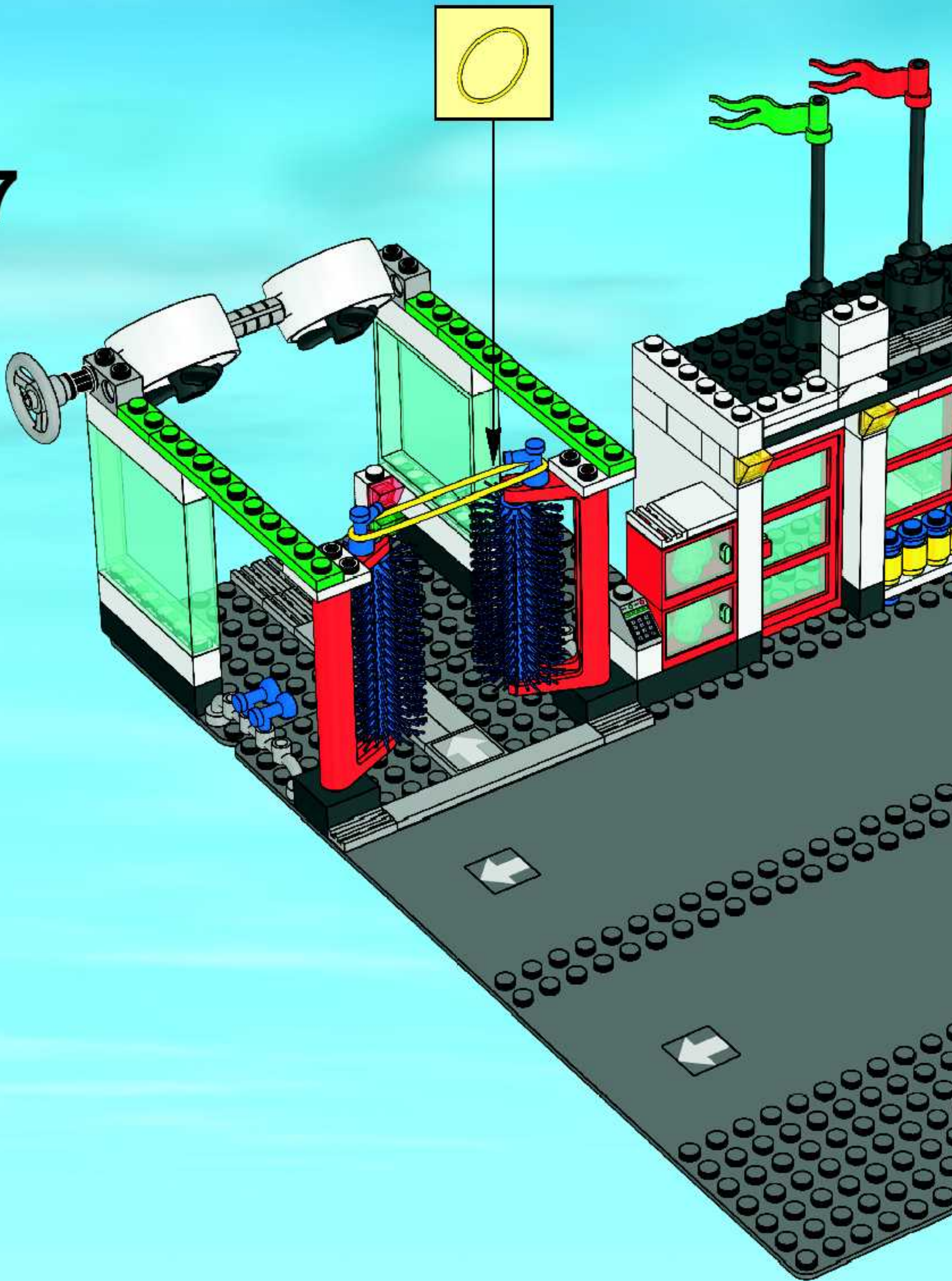



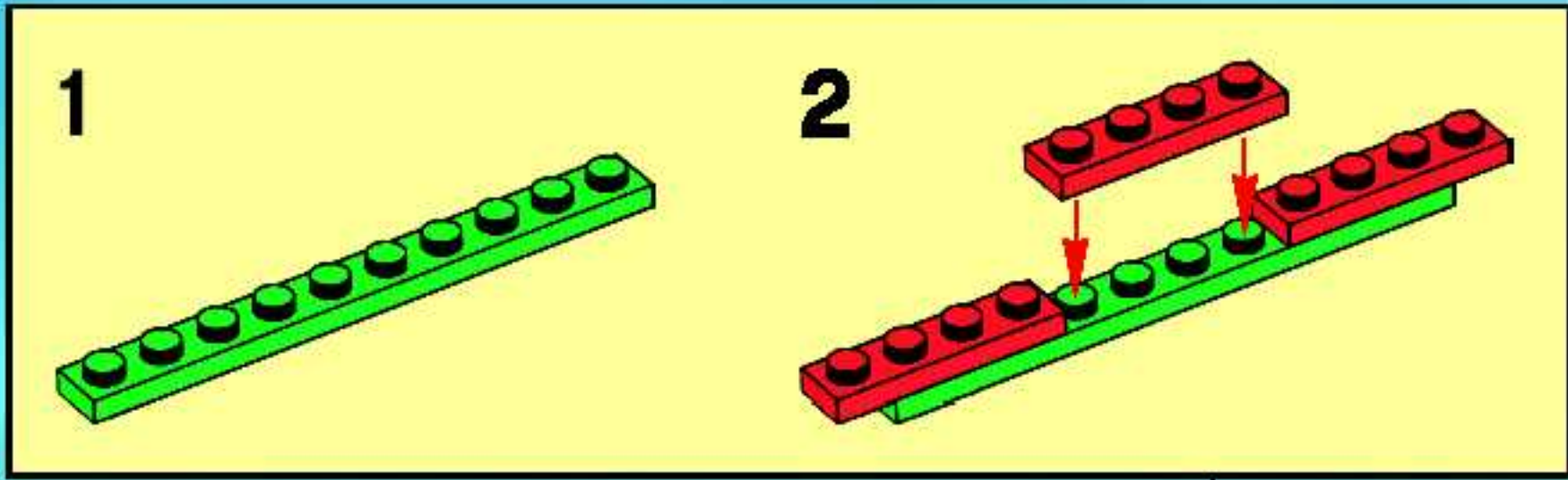

28

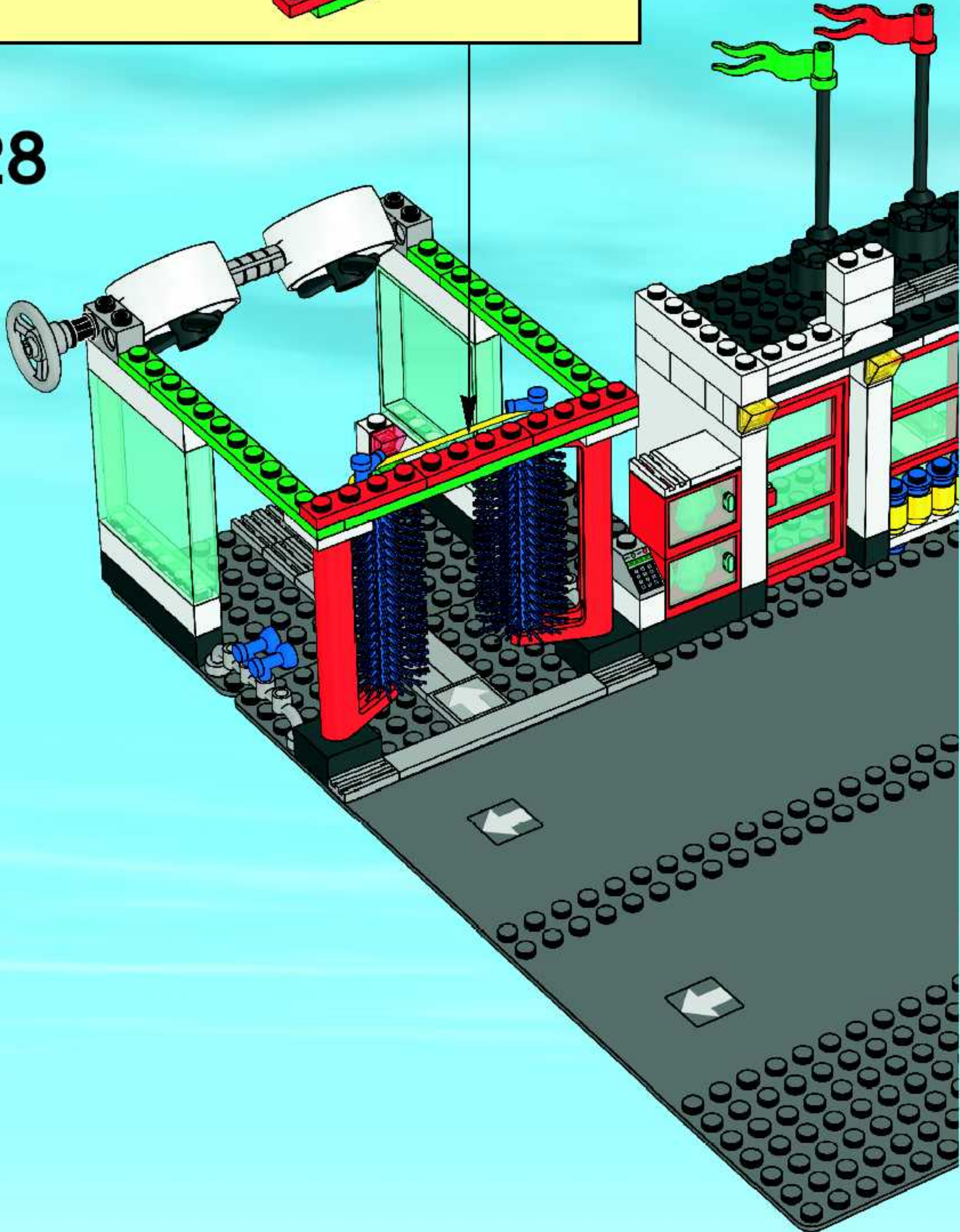



29

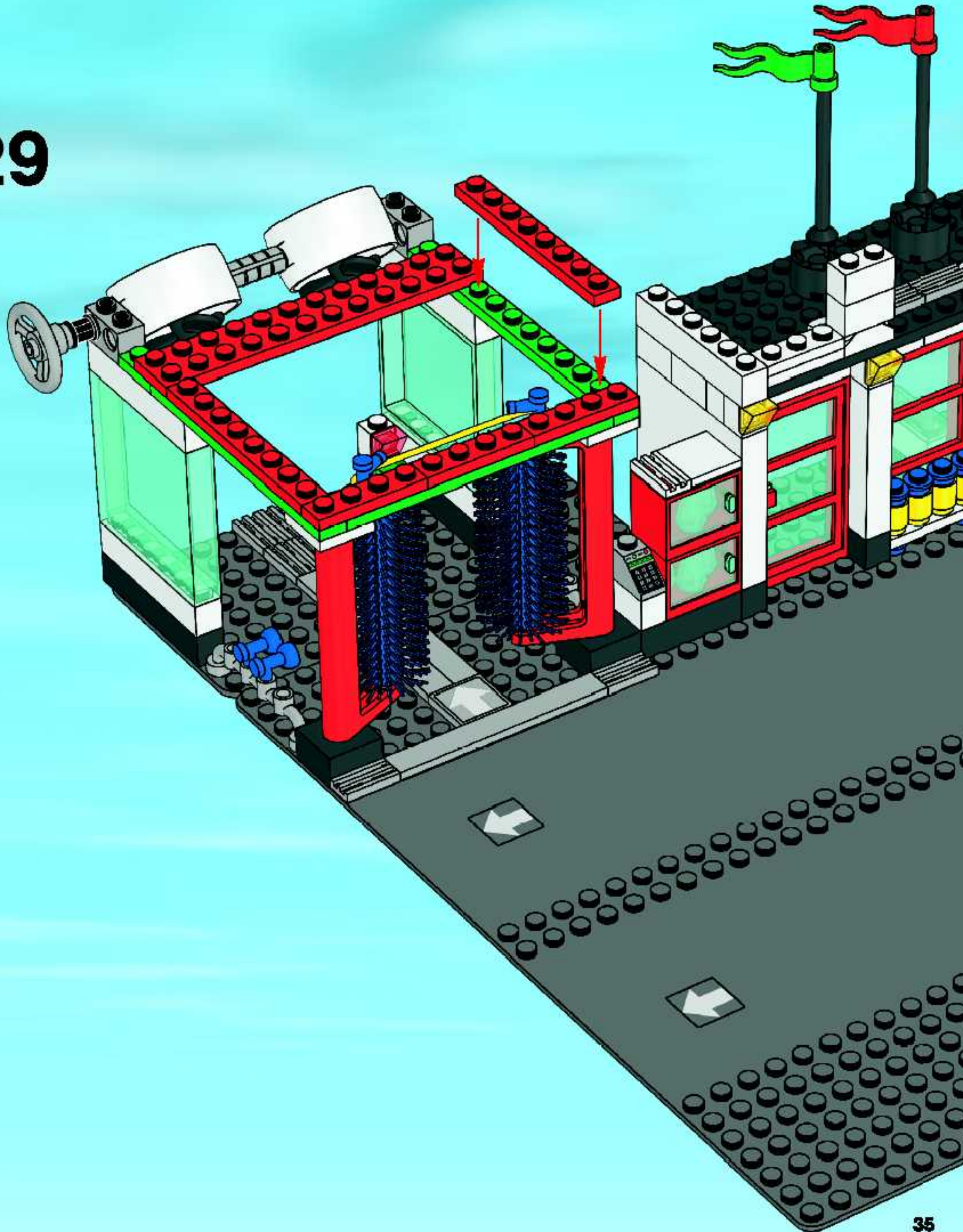



30

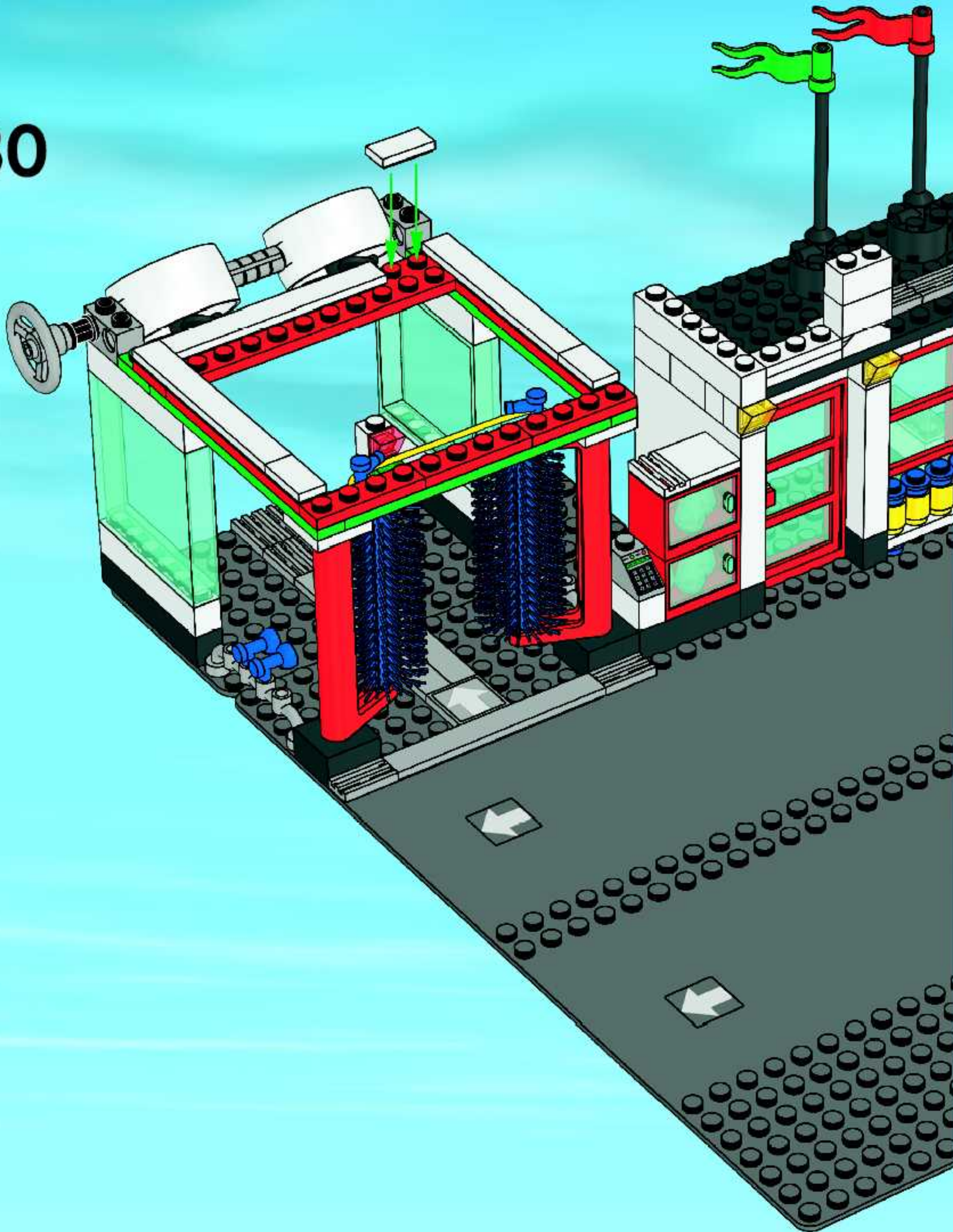



31

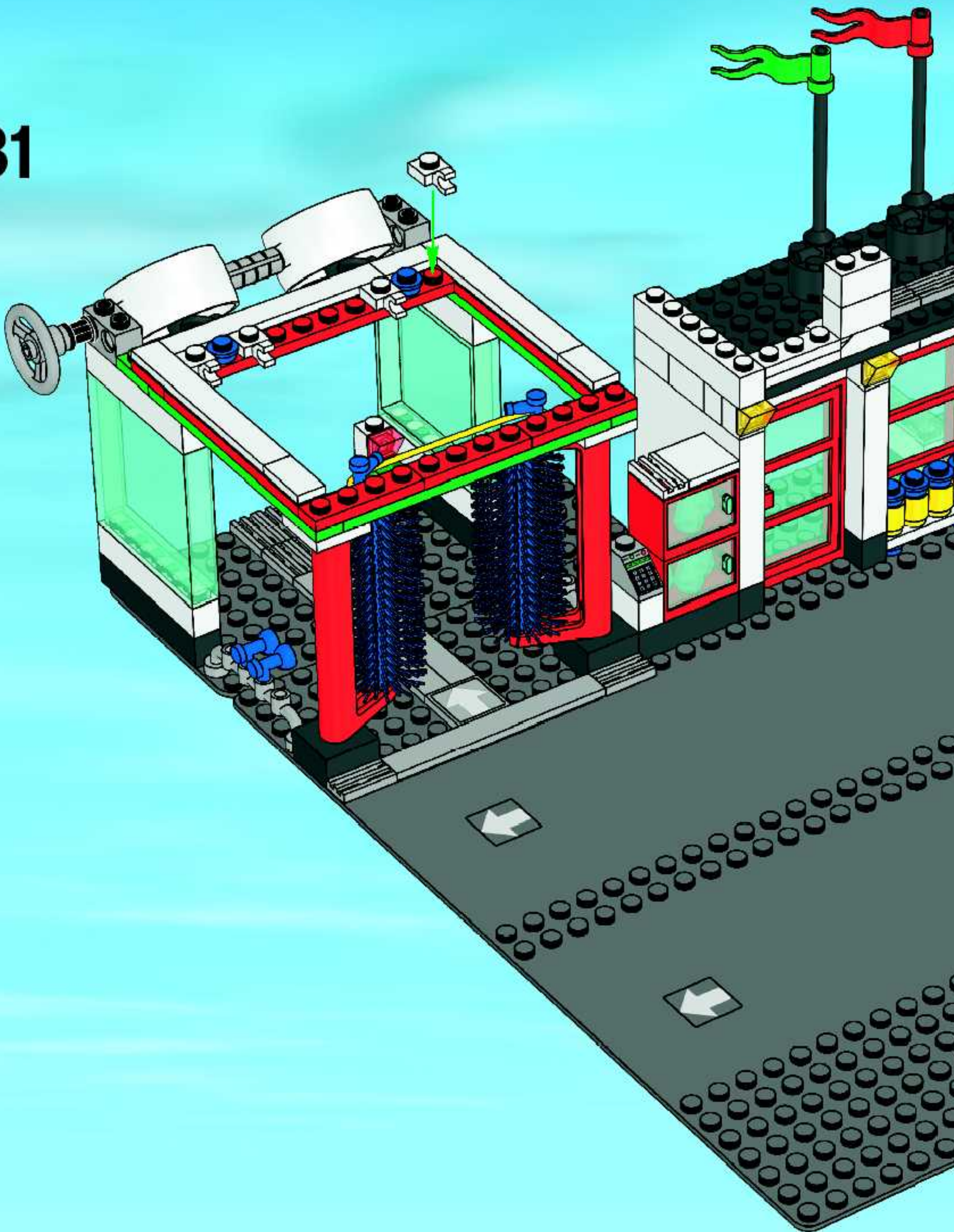



32

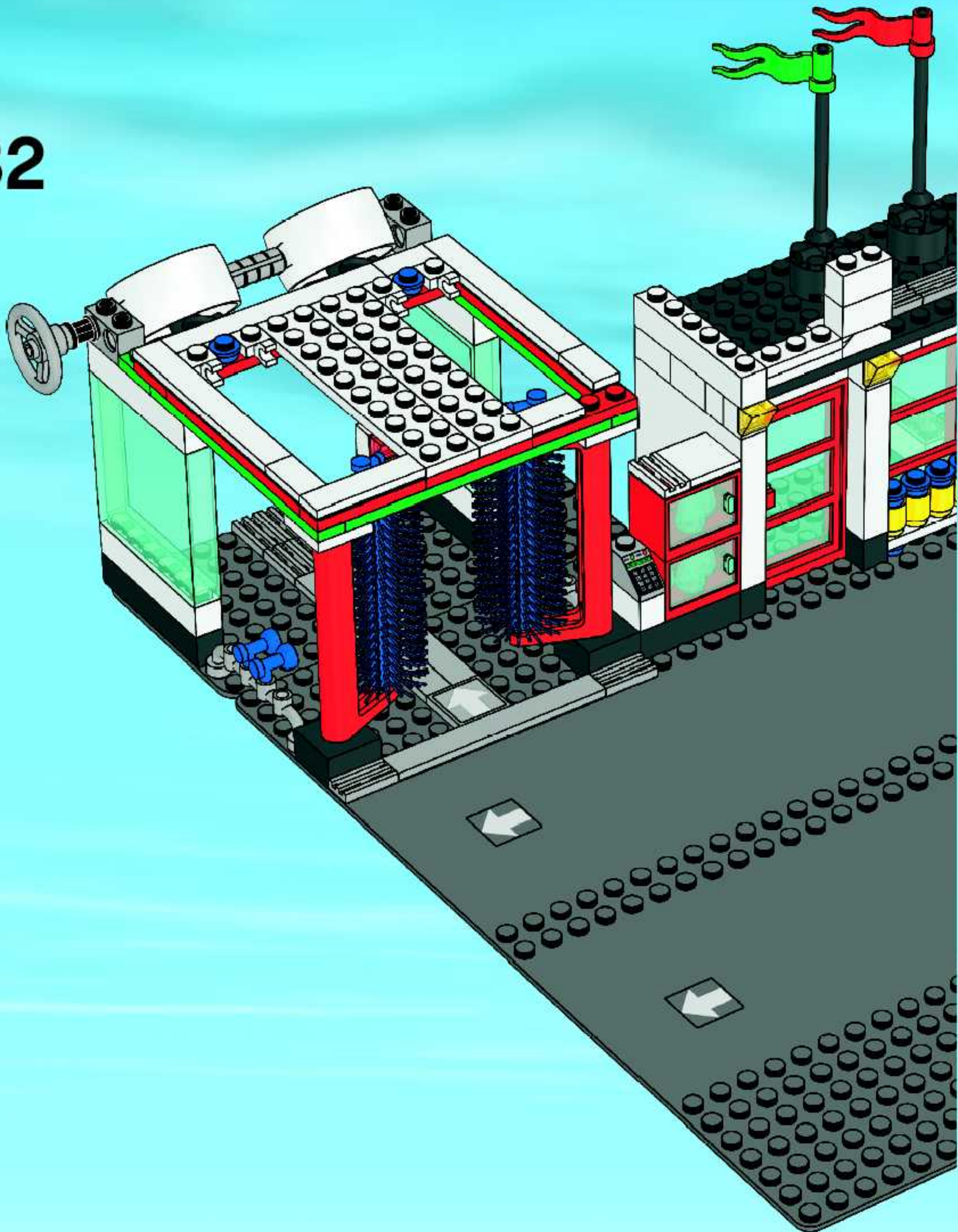



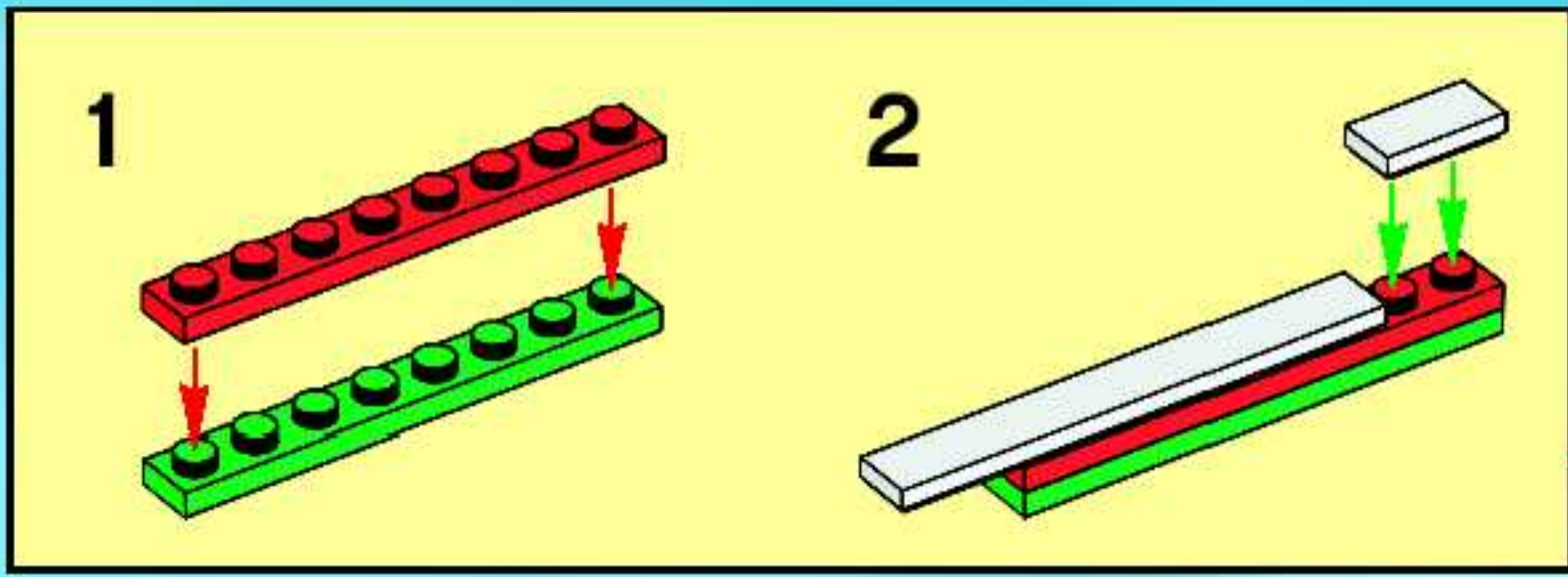

33

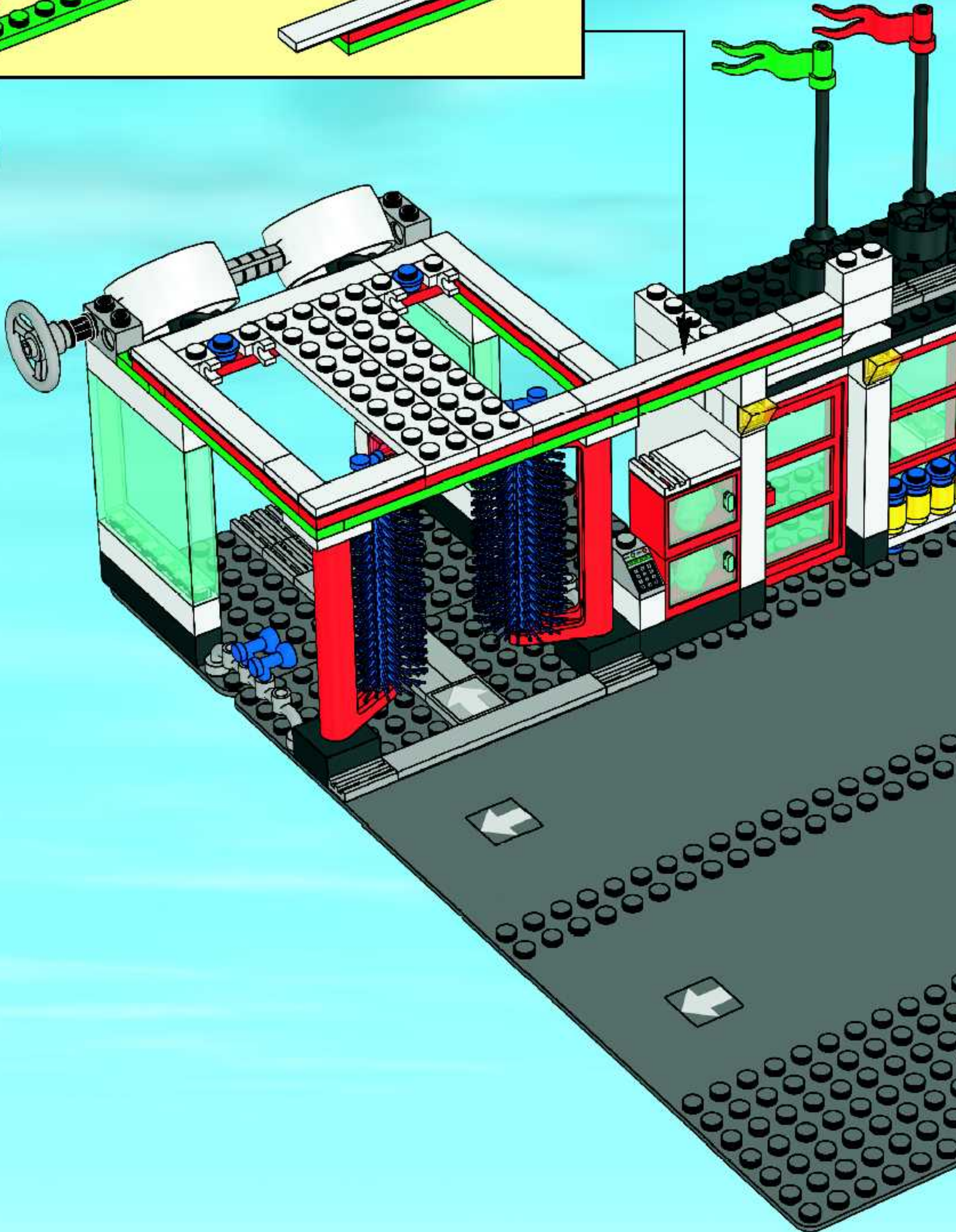



34

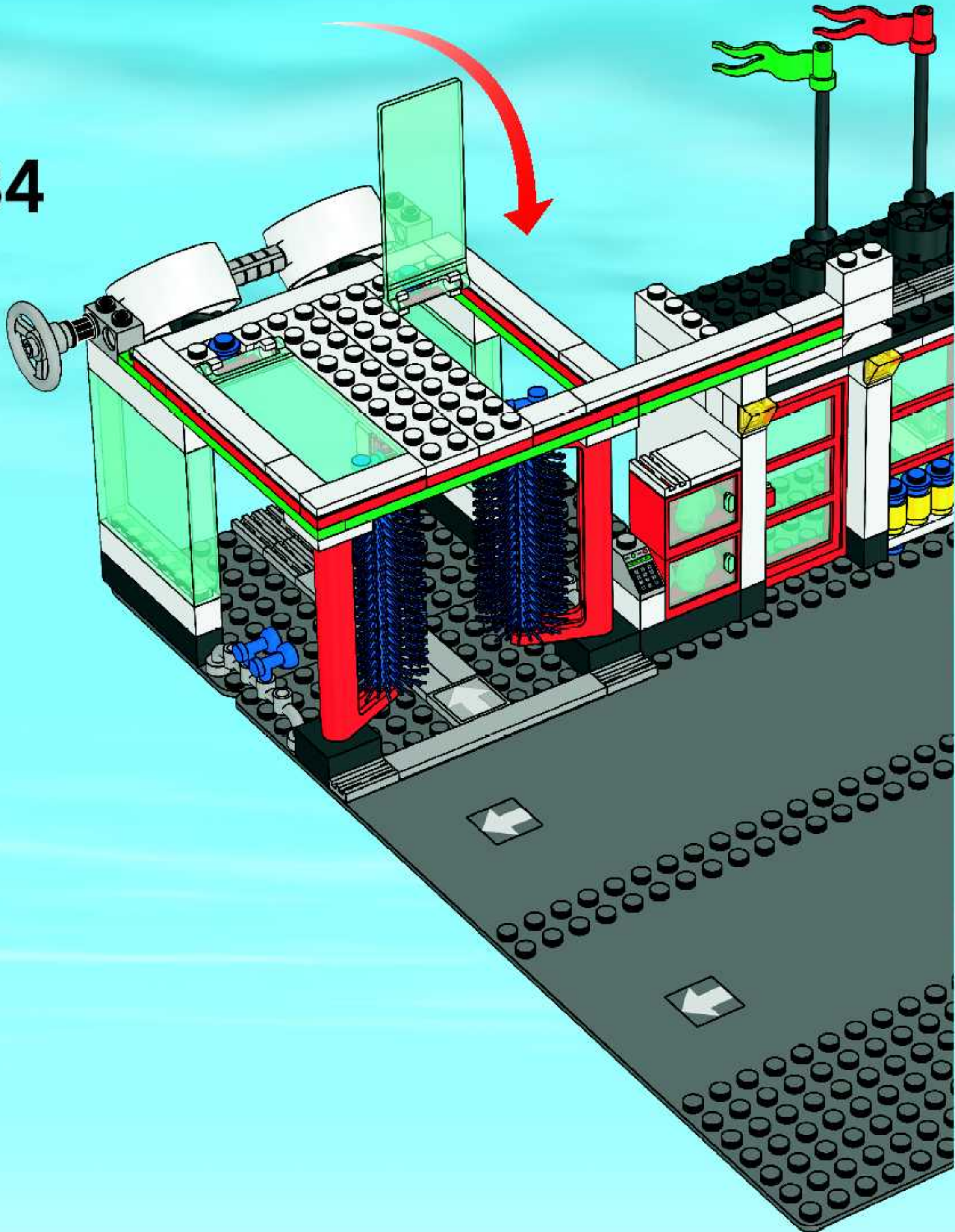



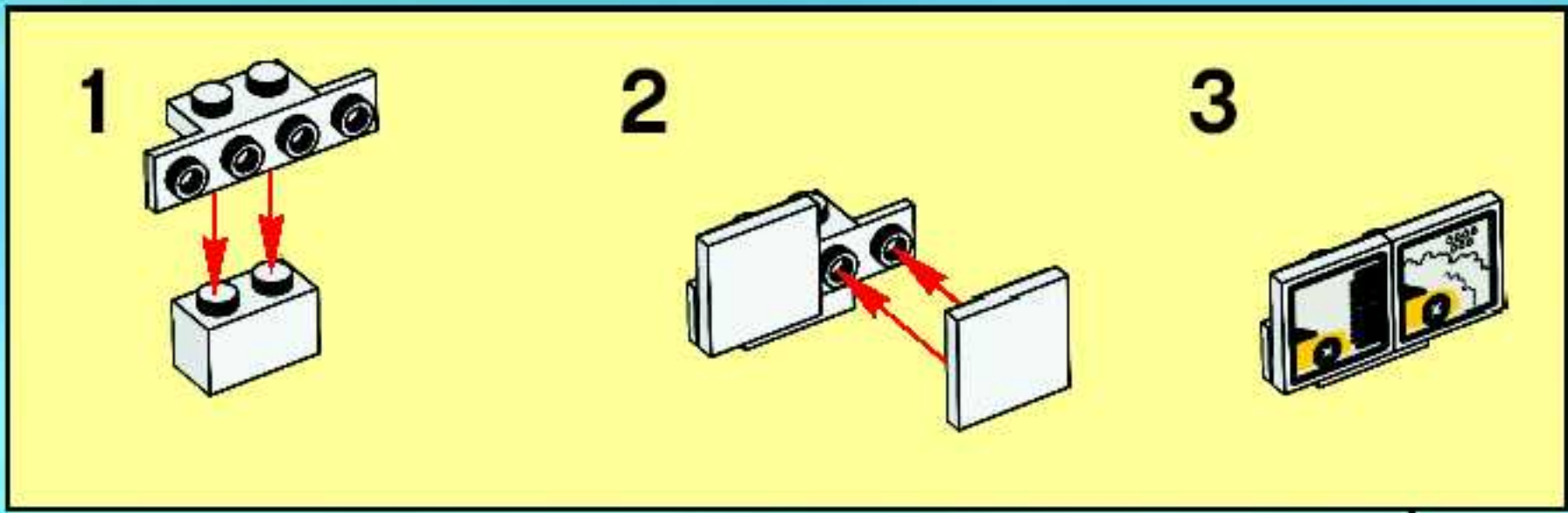

35

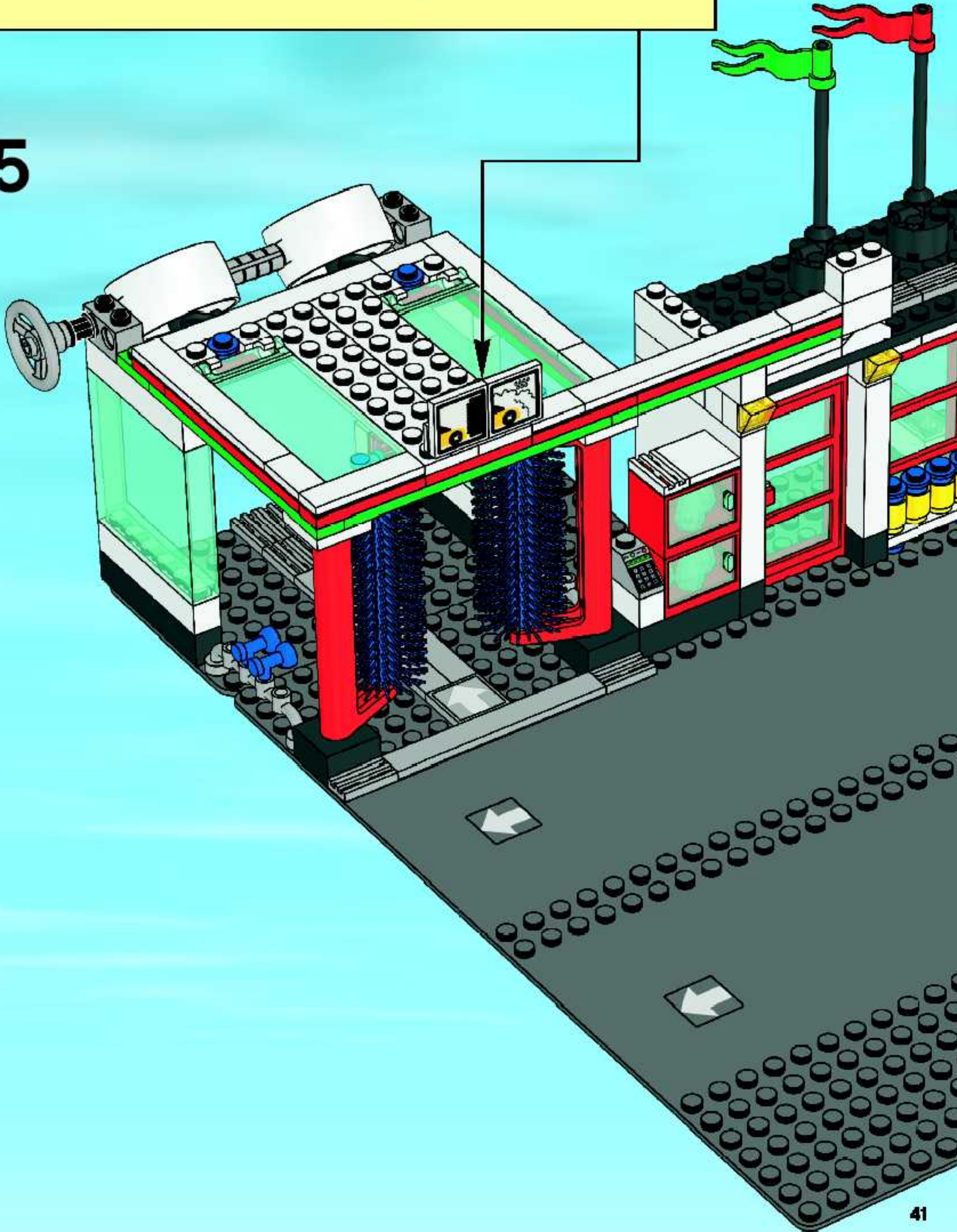



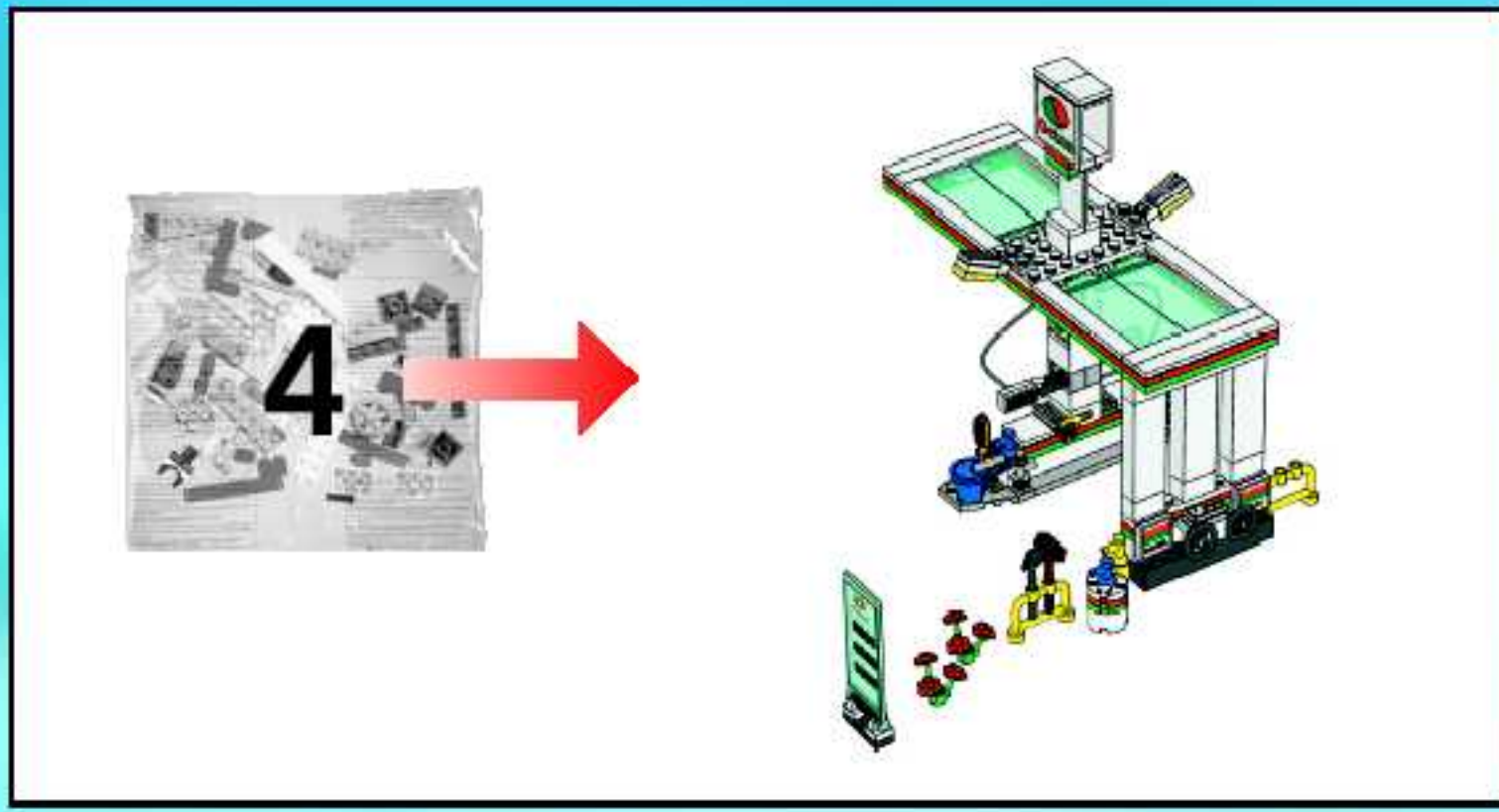

36

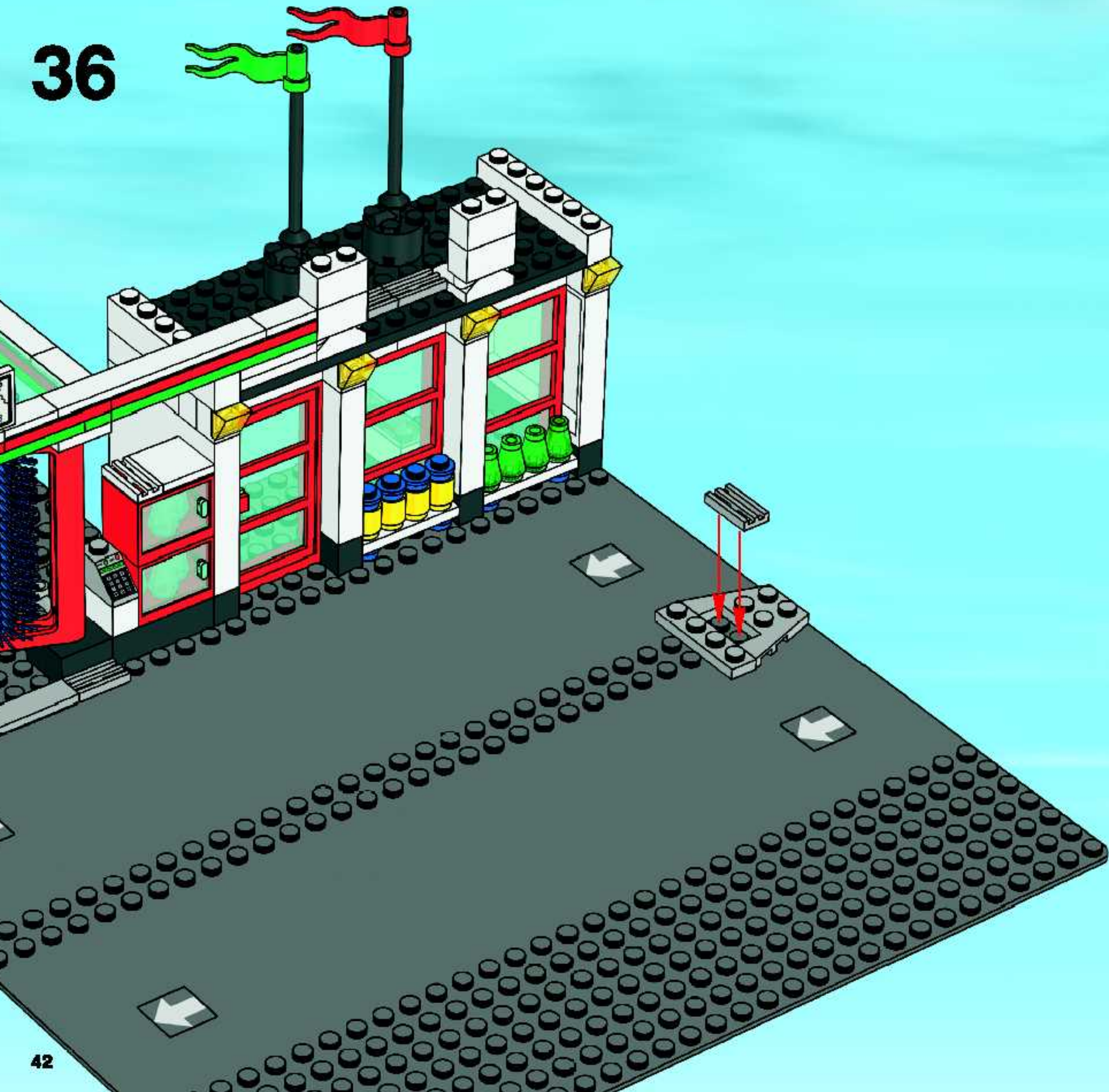



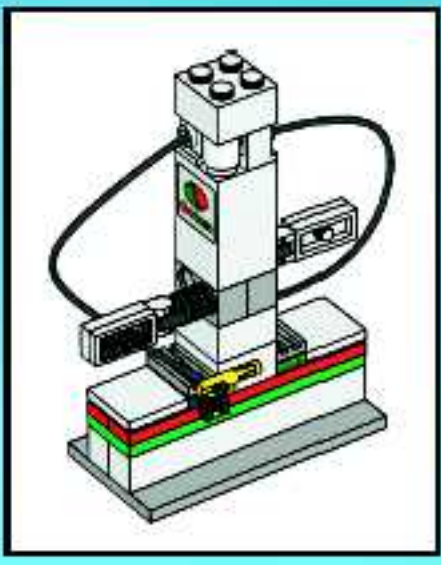

1

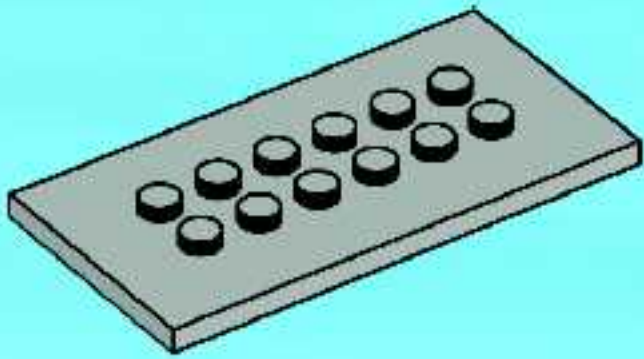

2

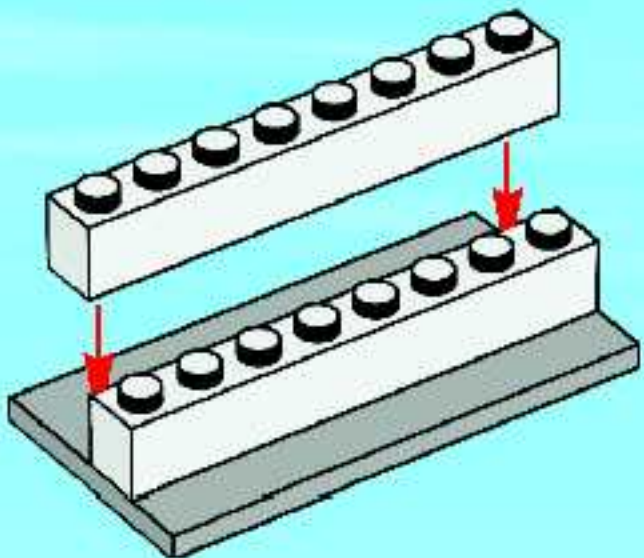

3

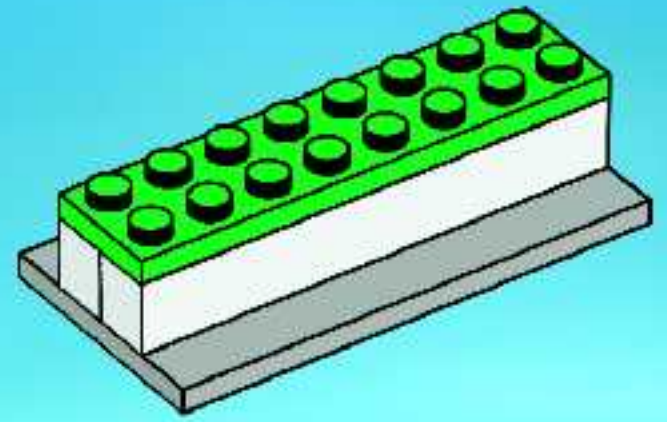

4

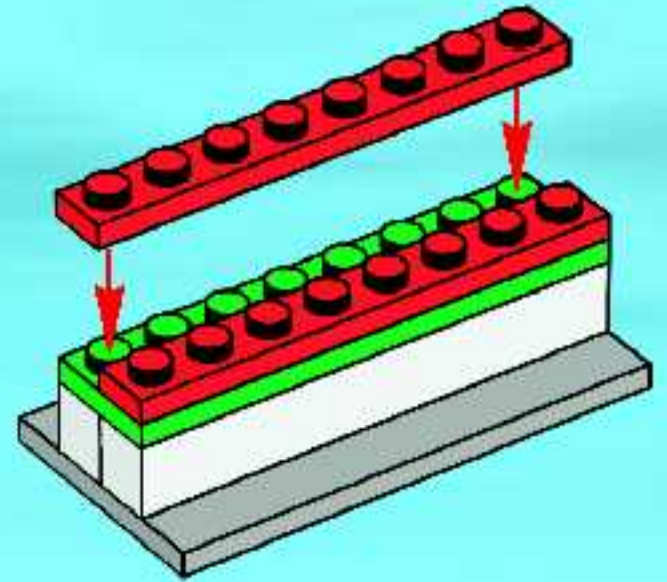

5

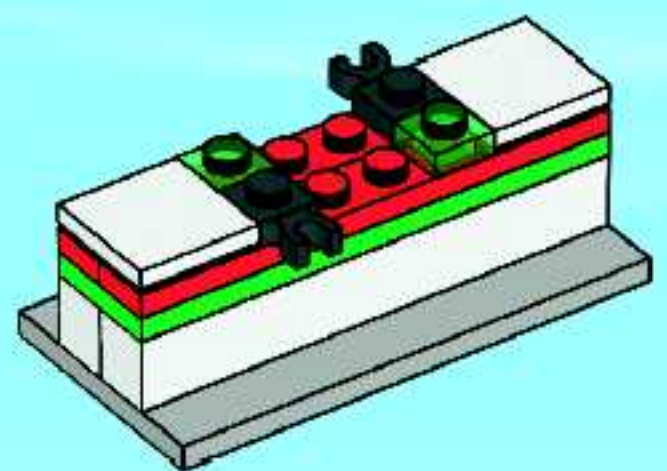



6

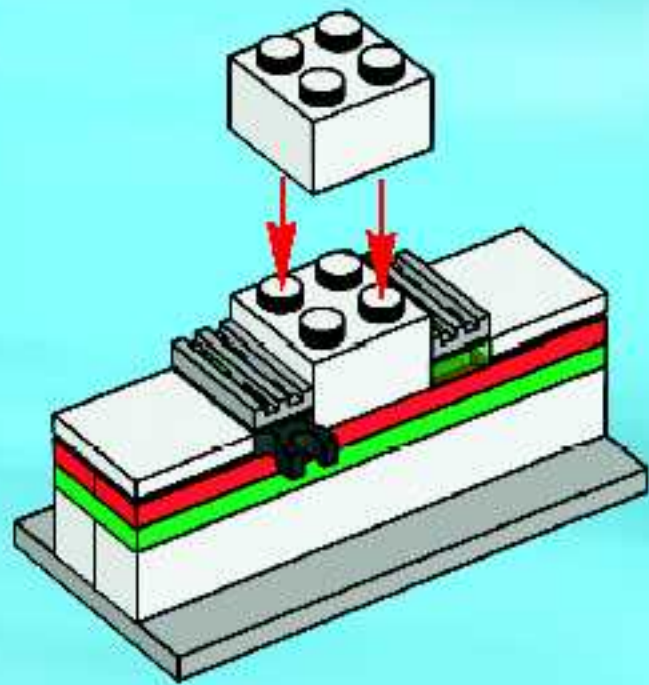

7

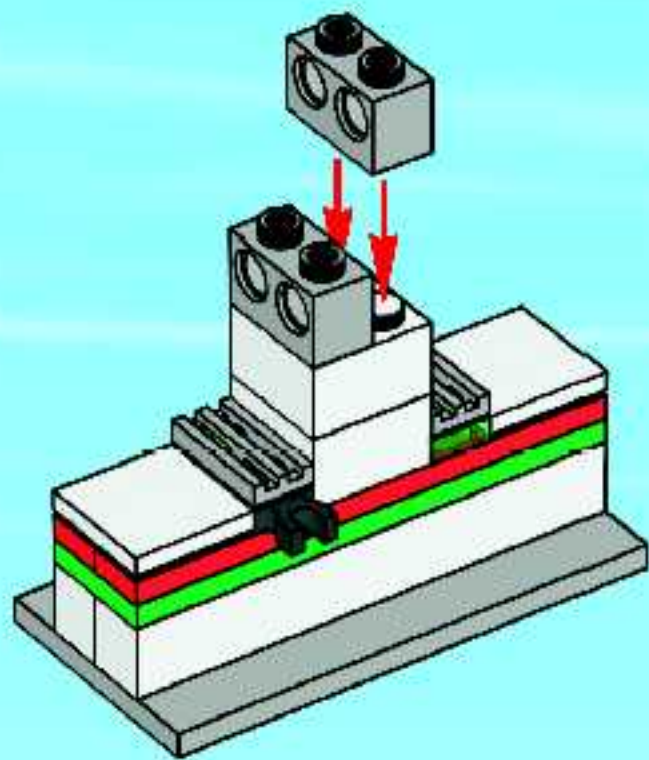

8

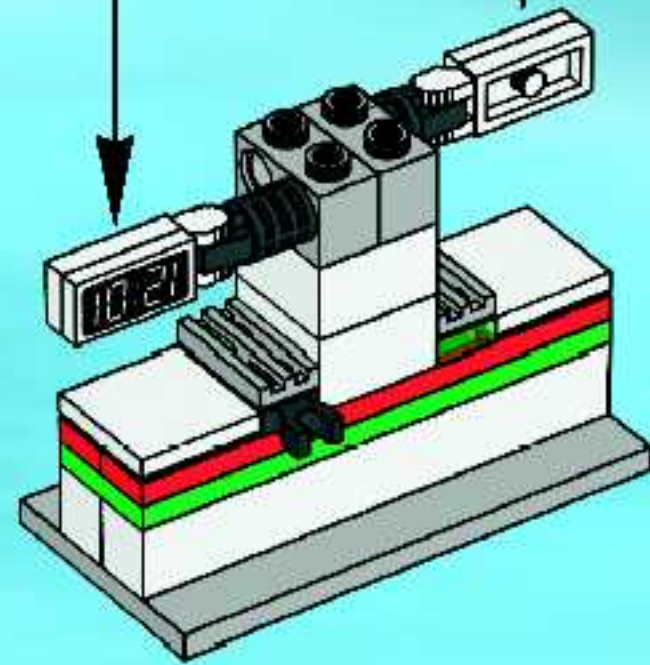

9

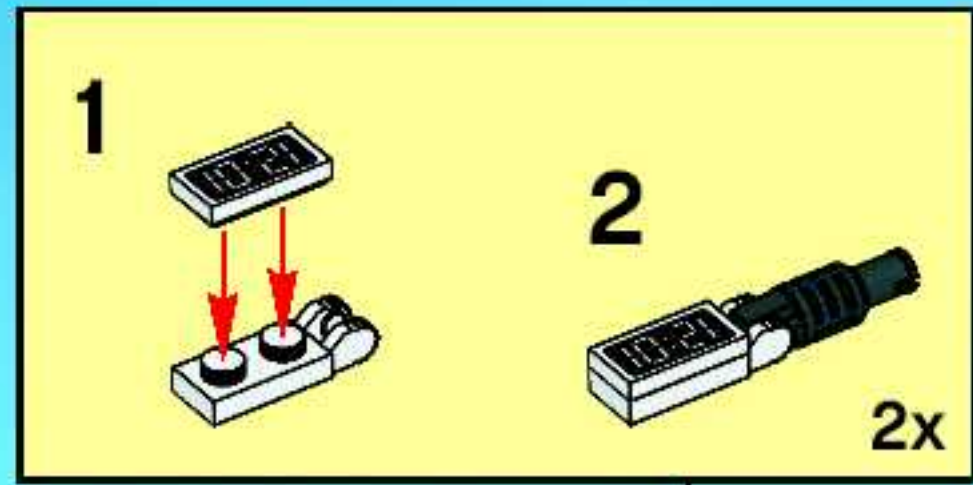
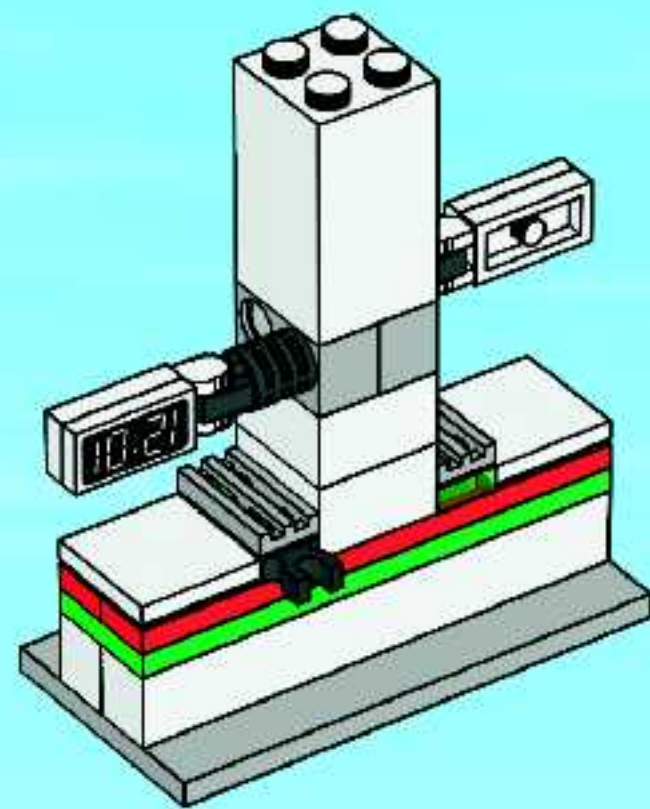



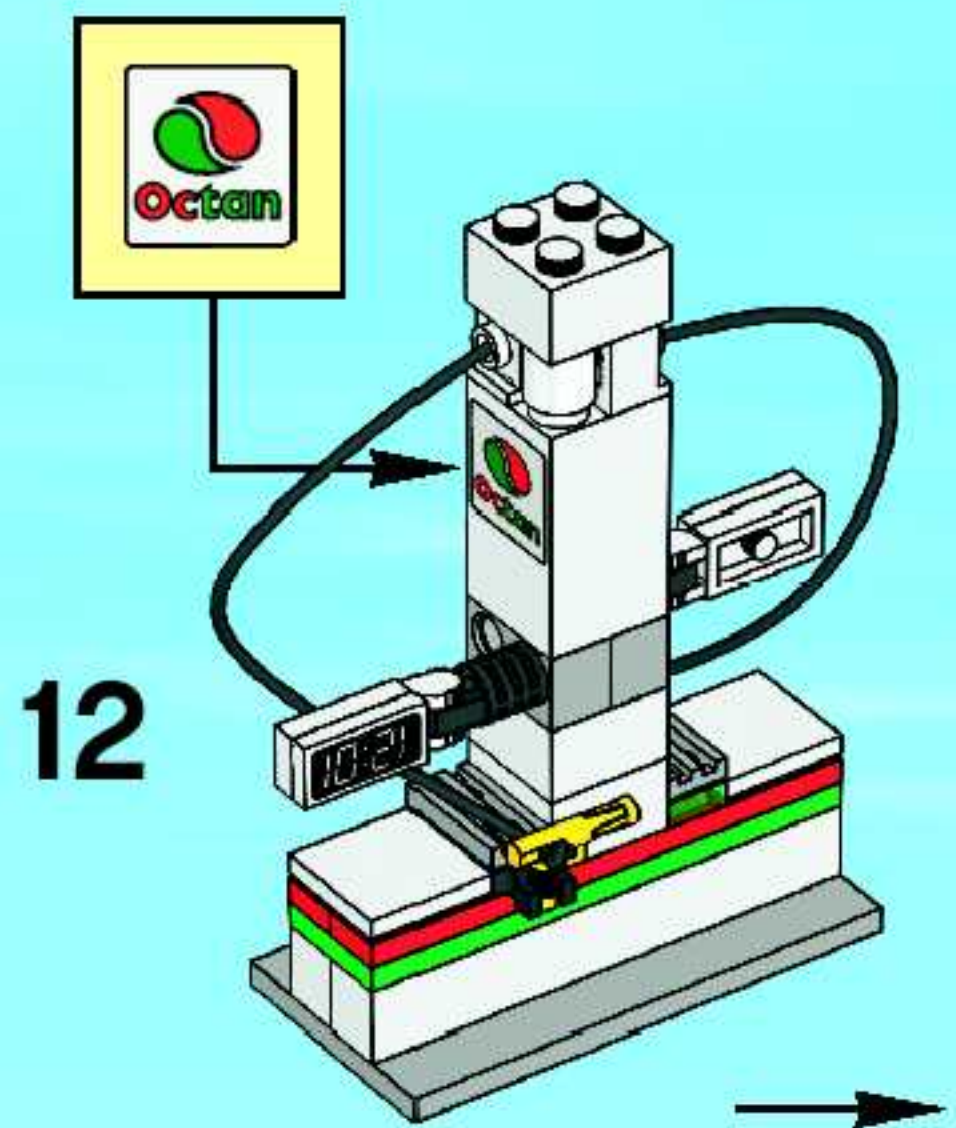
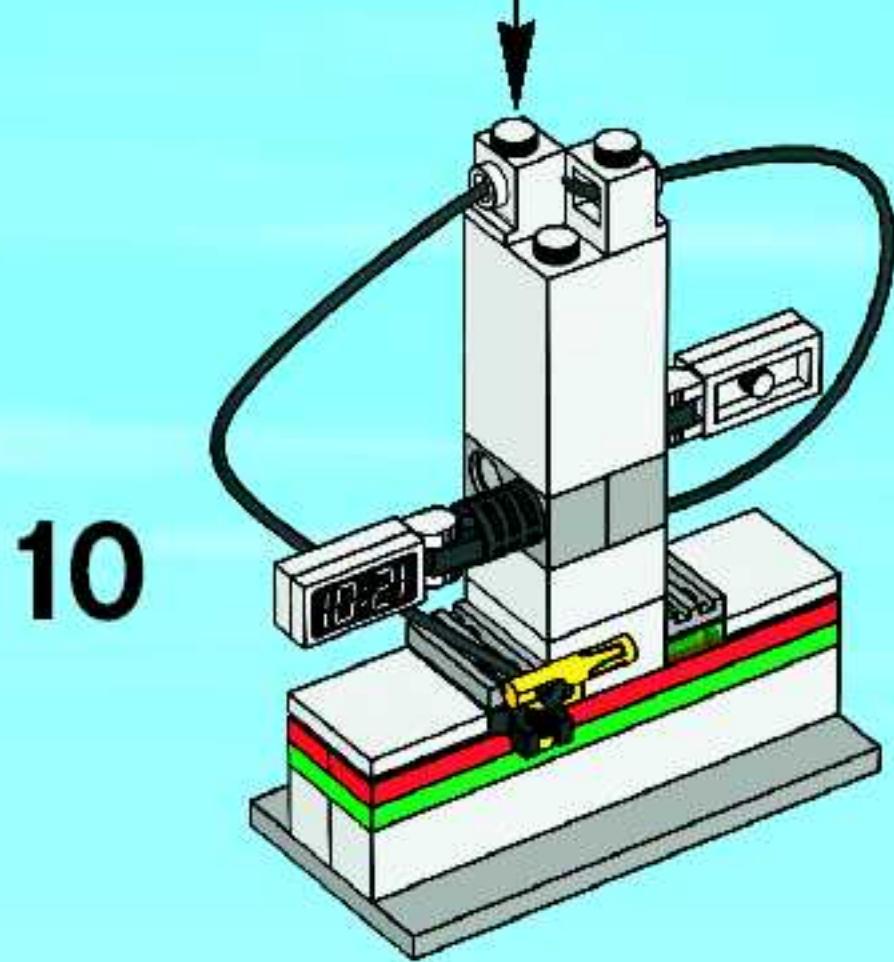
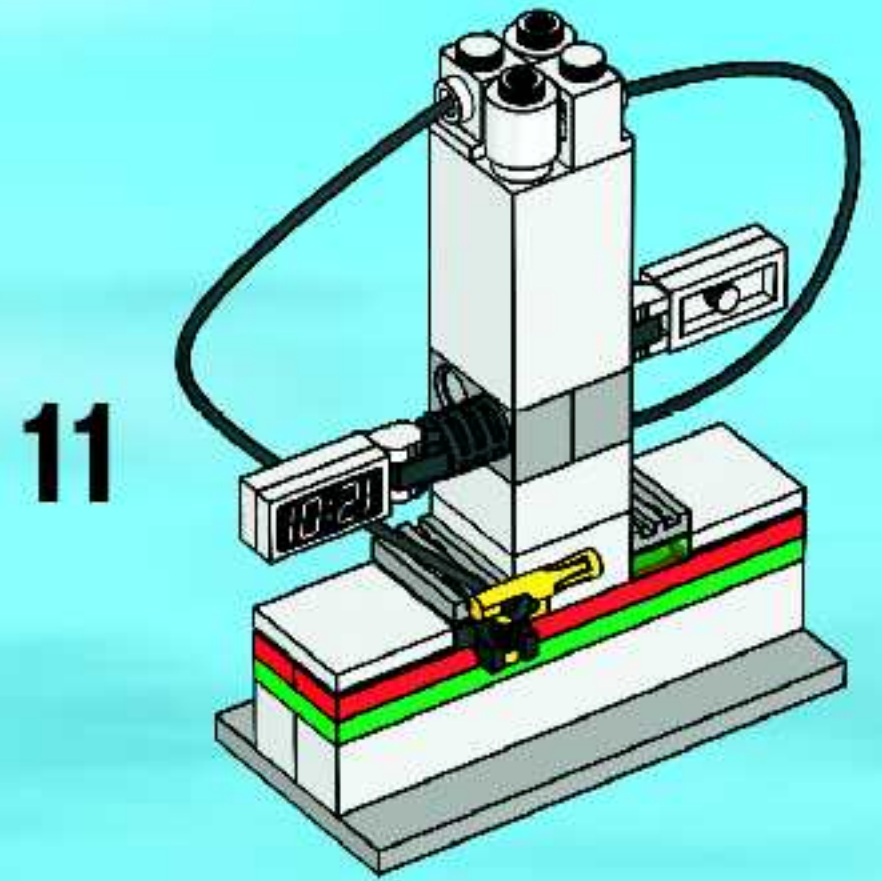
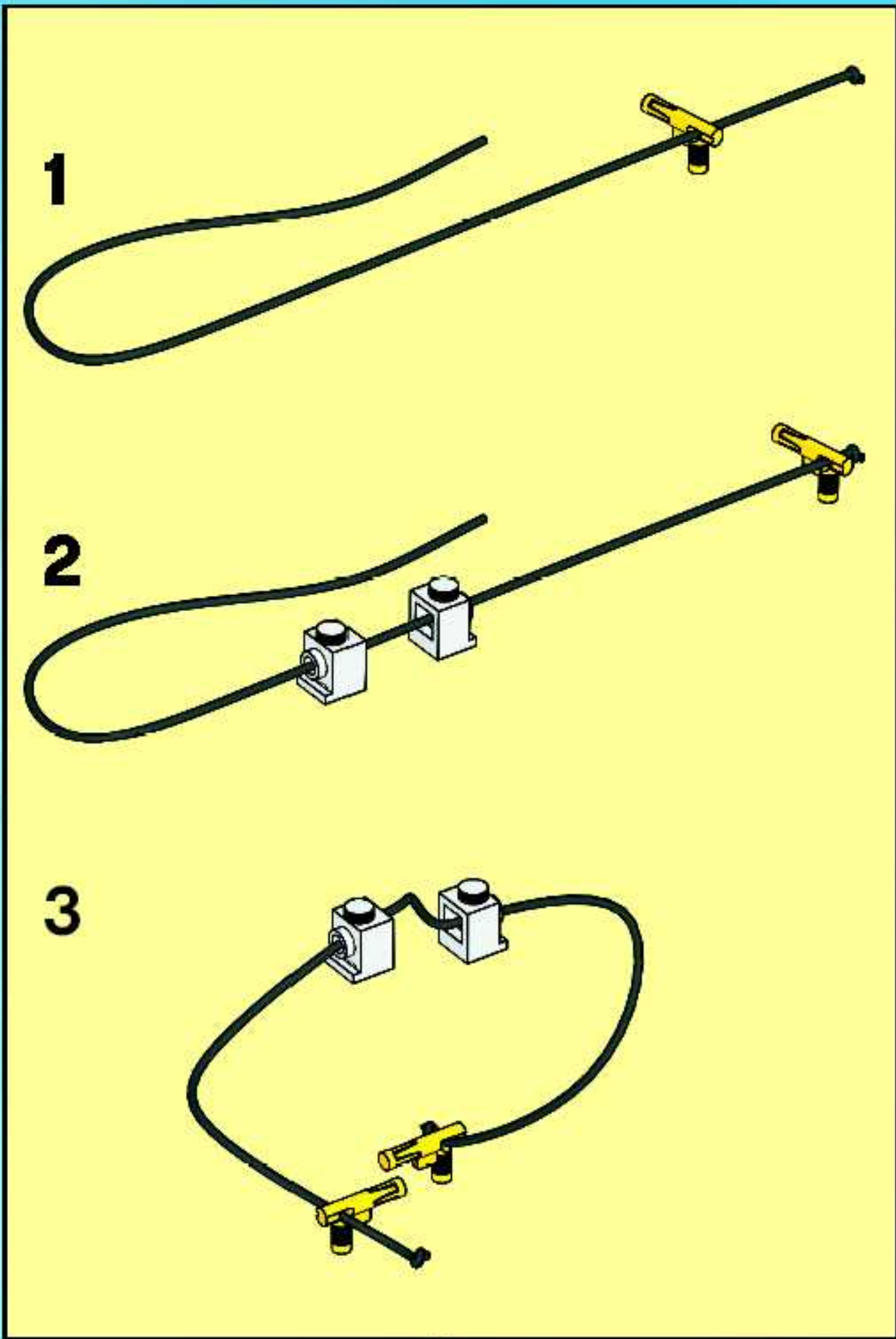



37

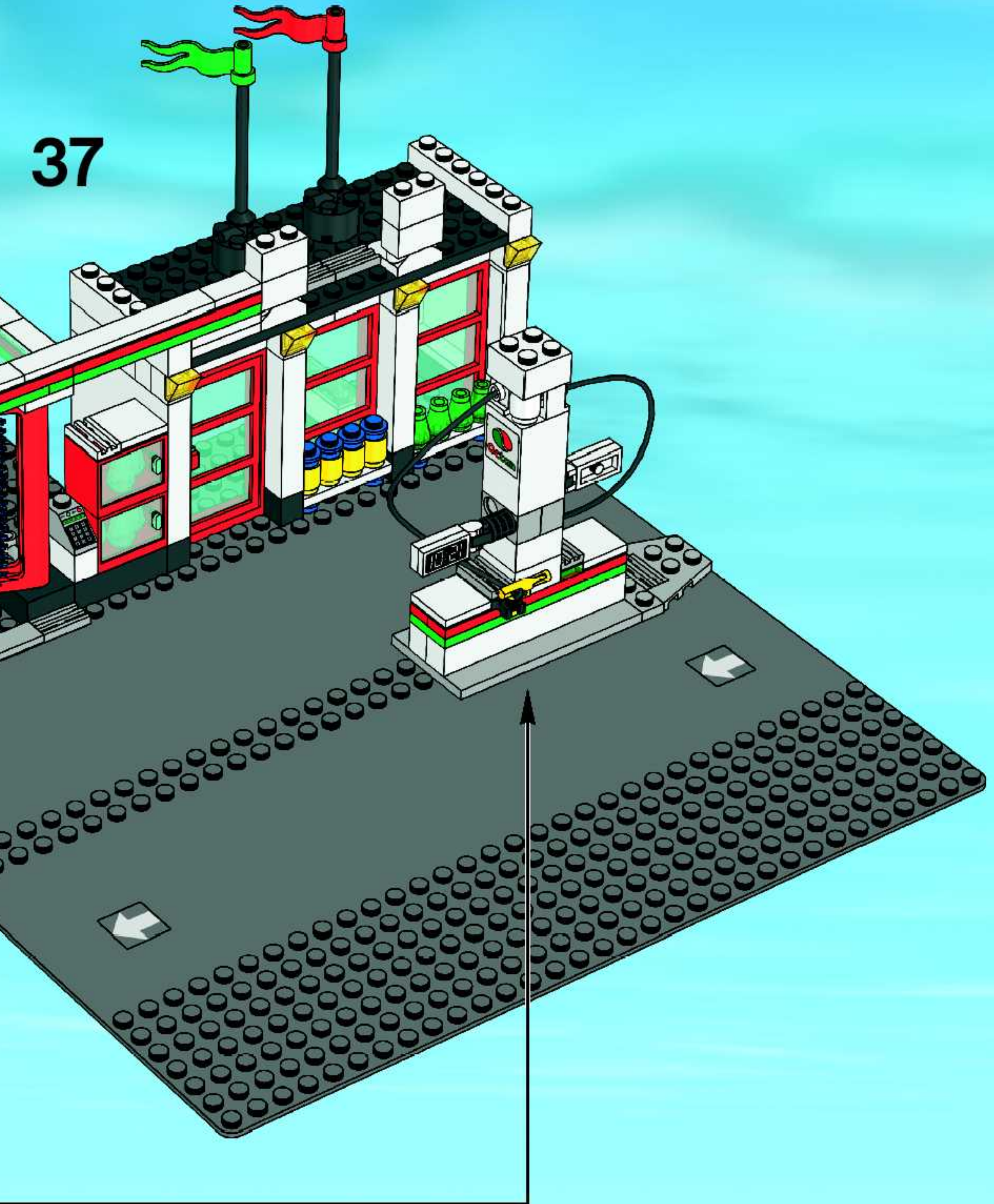



38

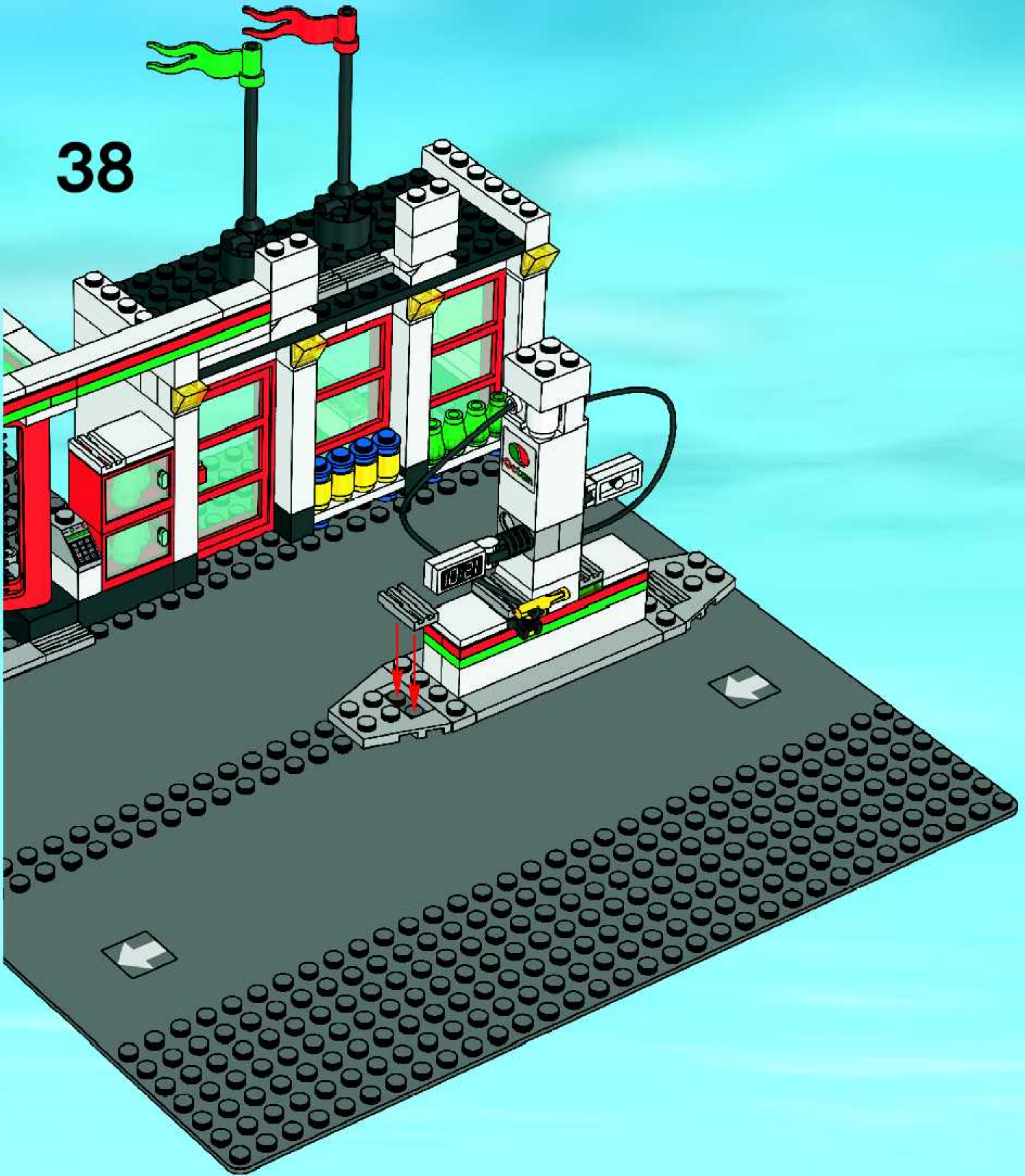



39

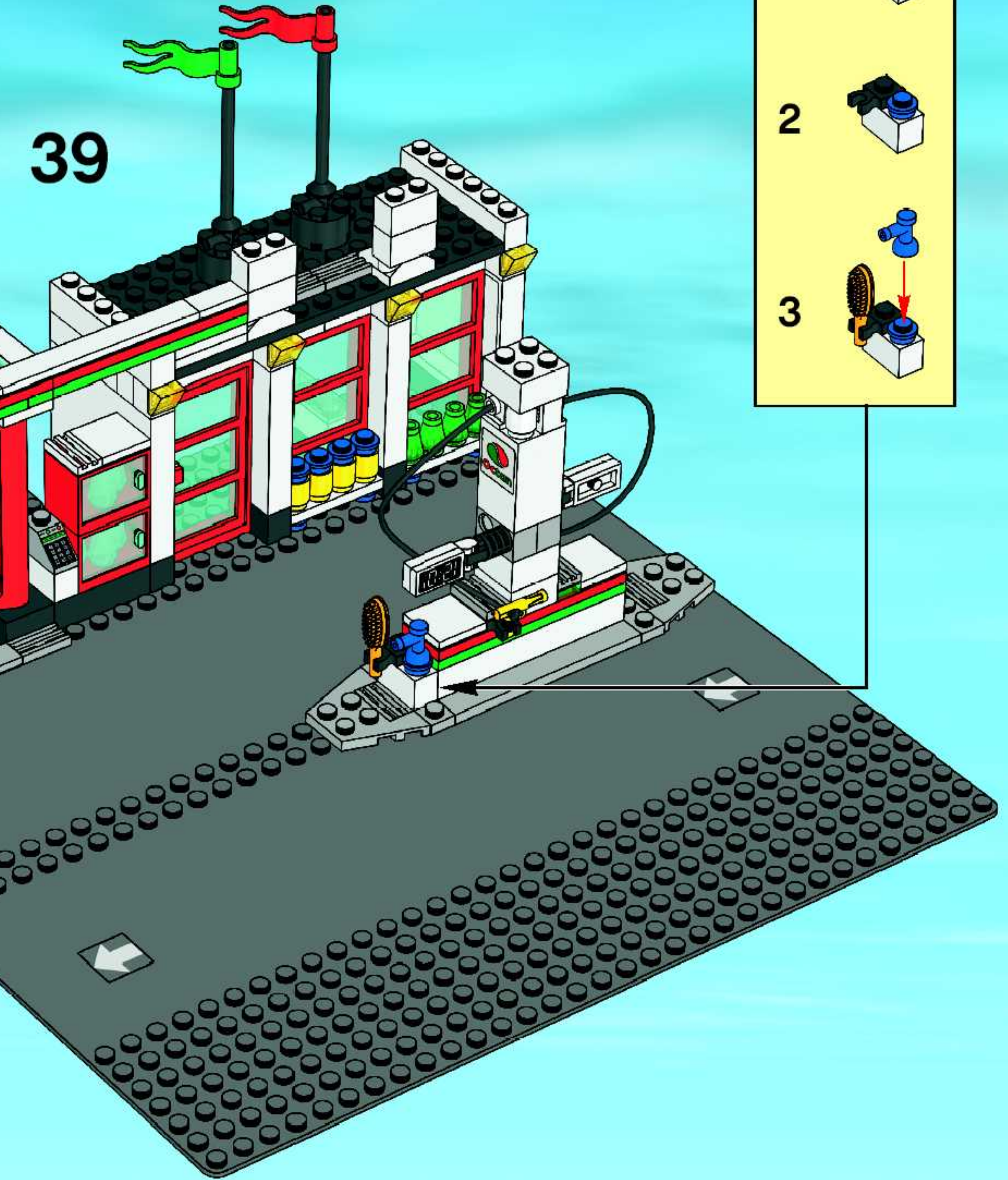

1

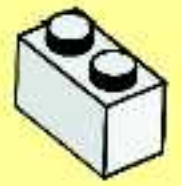

2



3





40

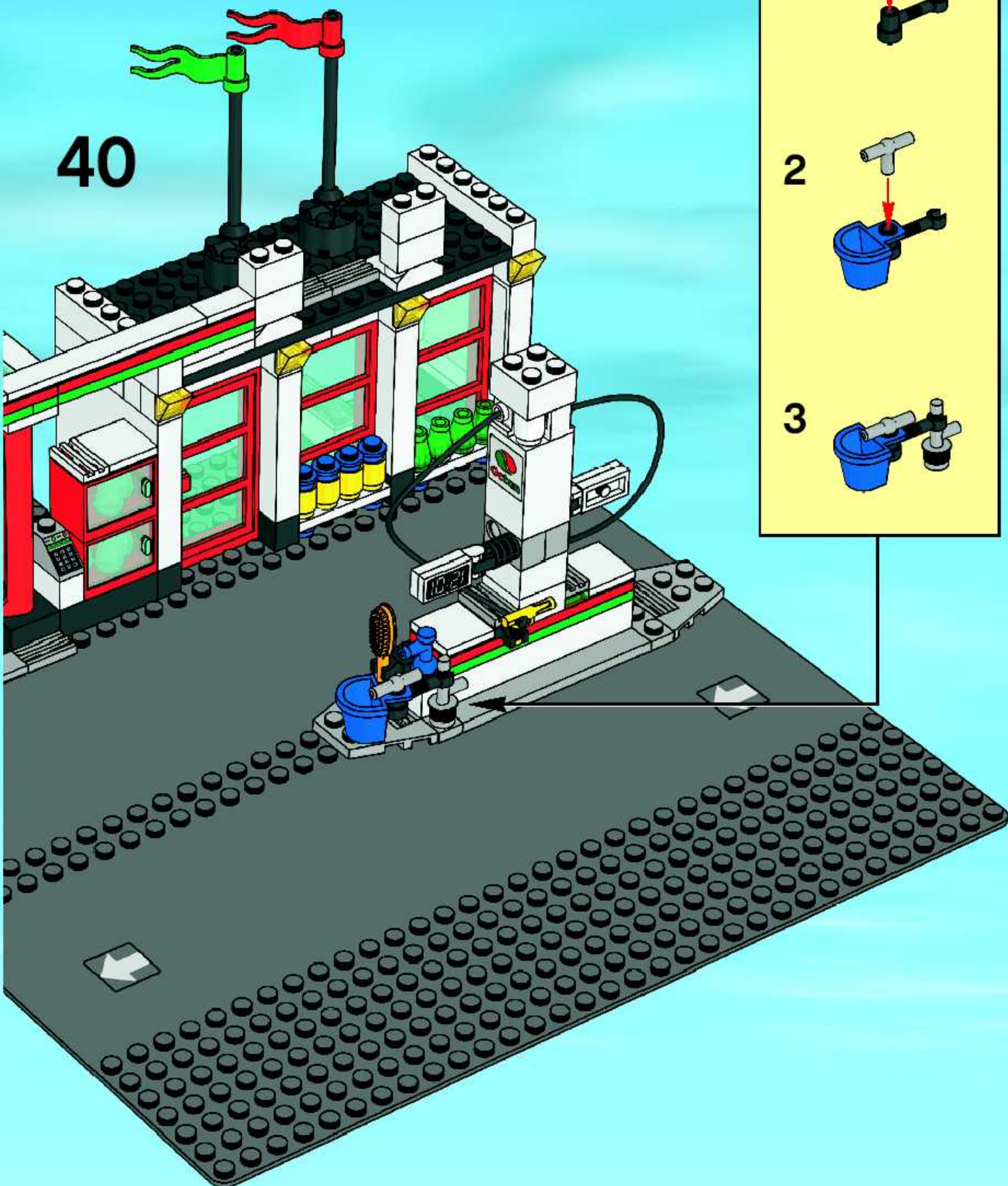

1



2



3





41

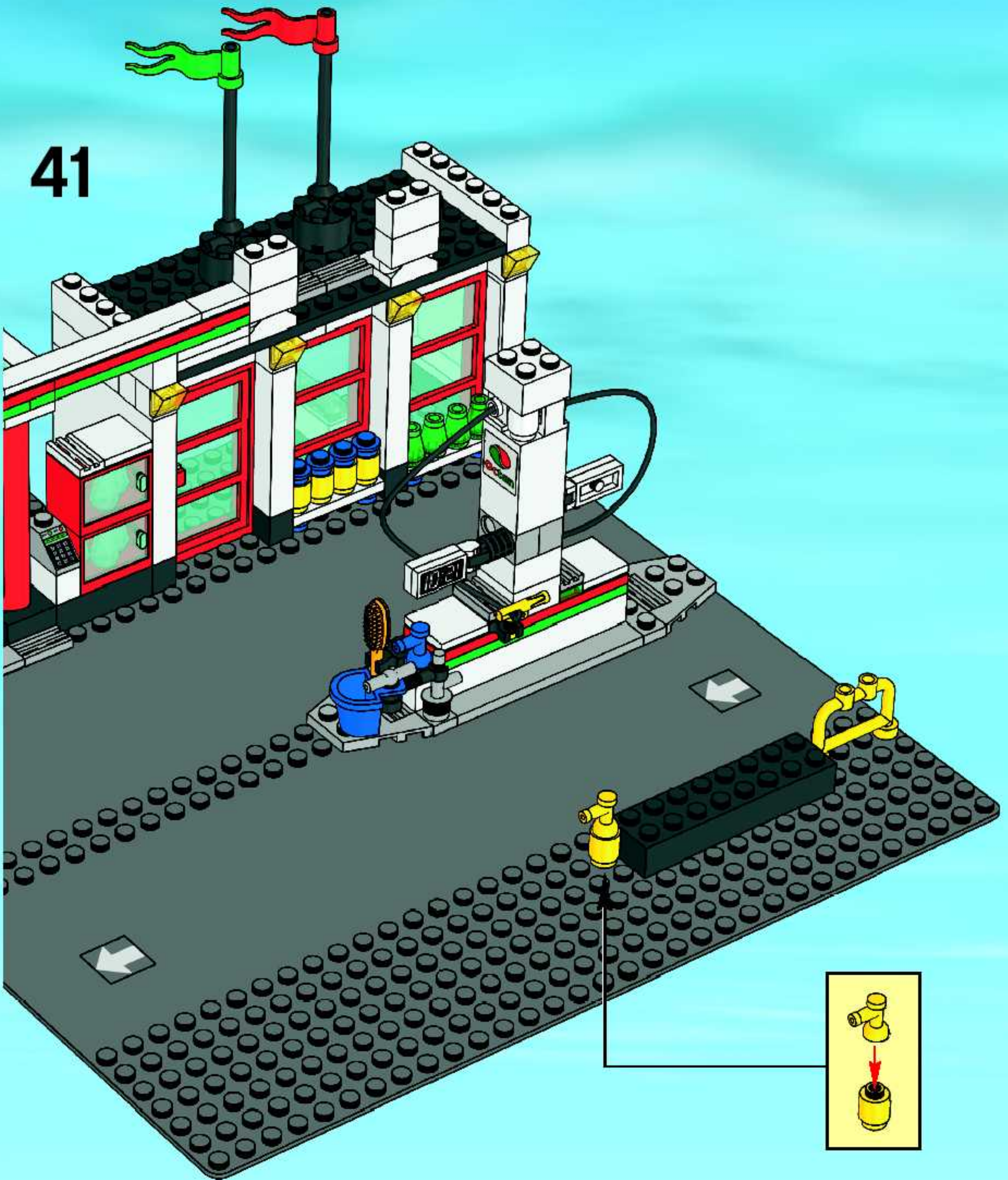





1

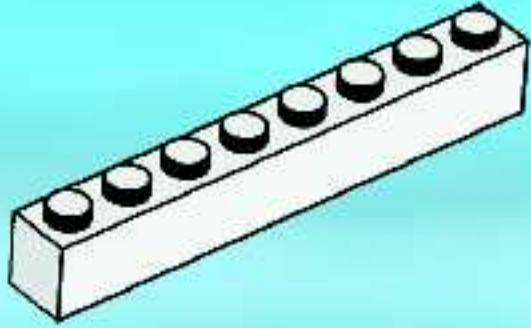

2

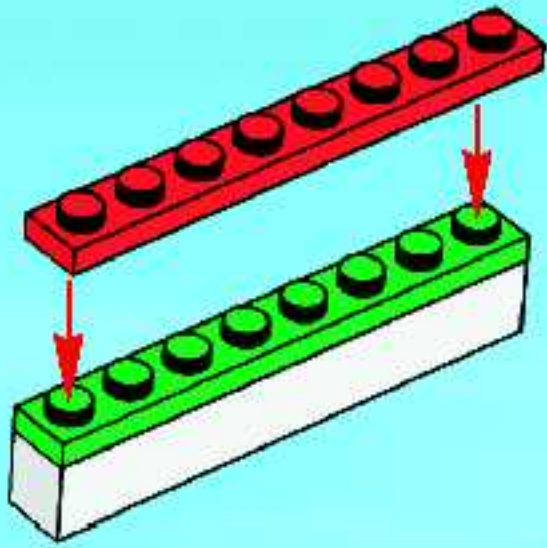

3

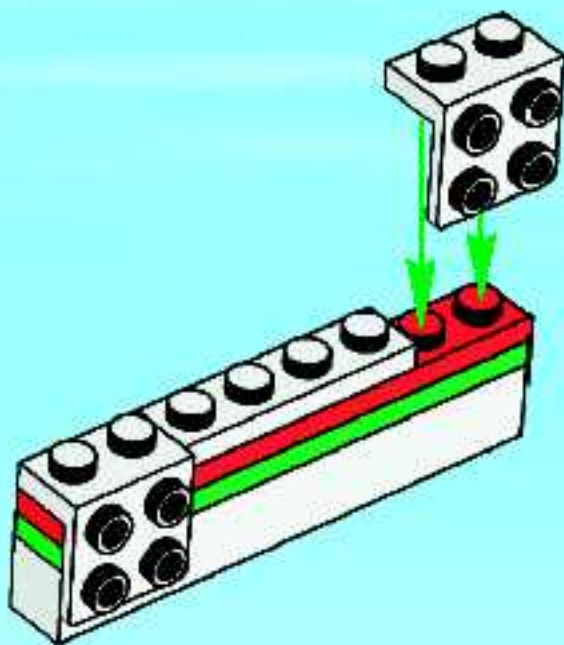

4

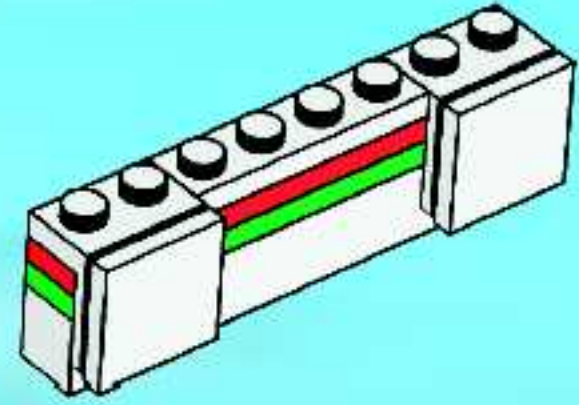

5





42

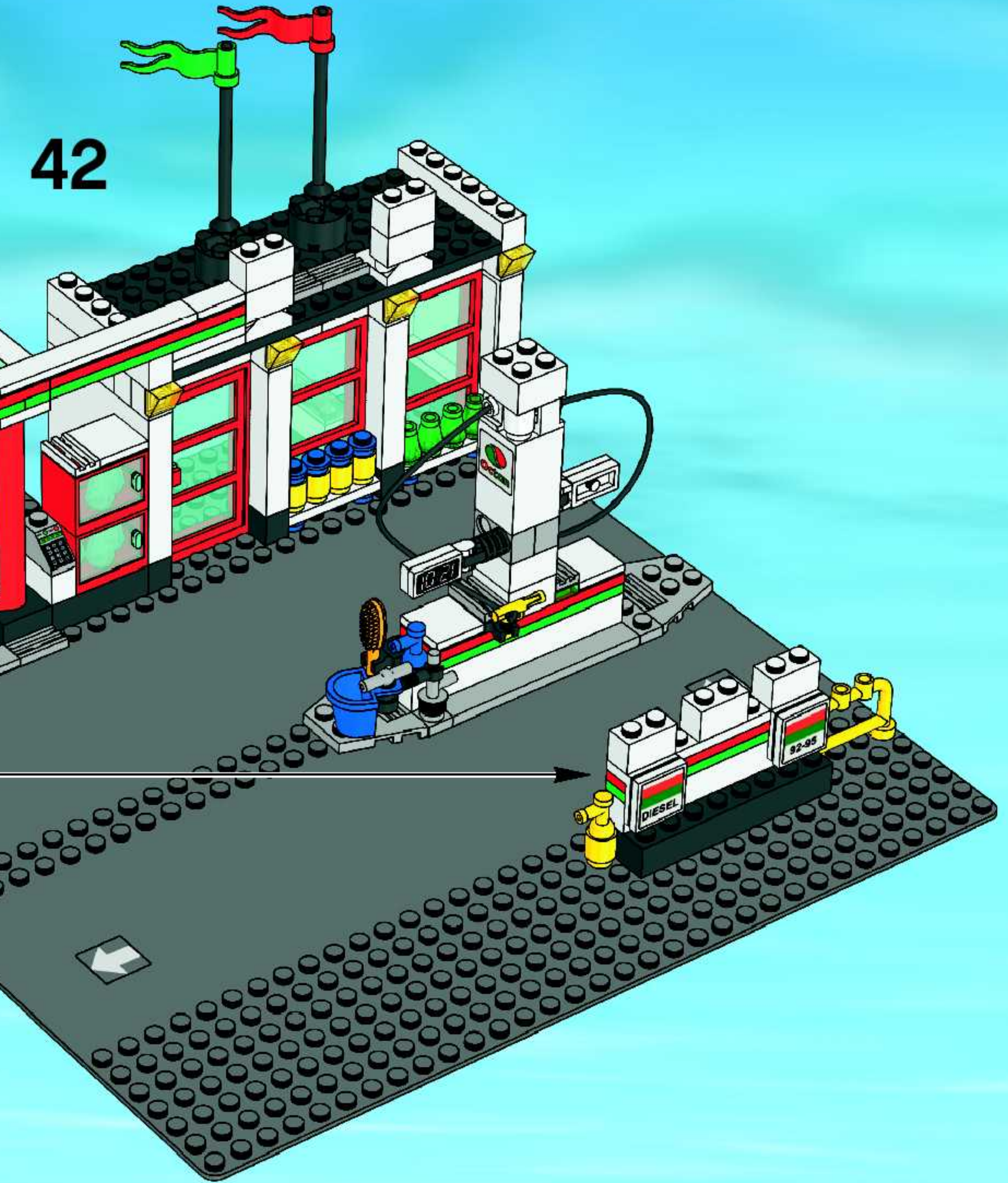



43

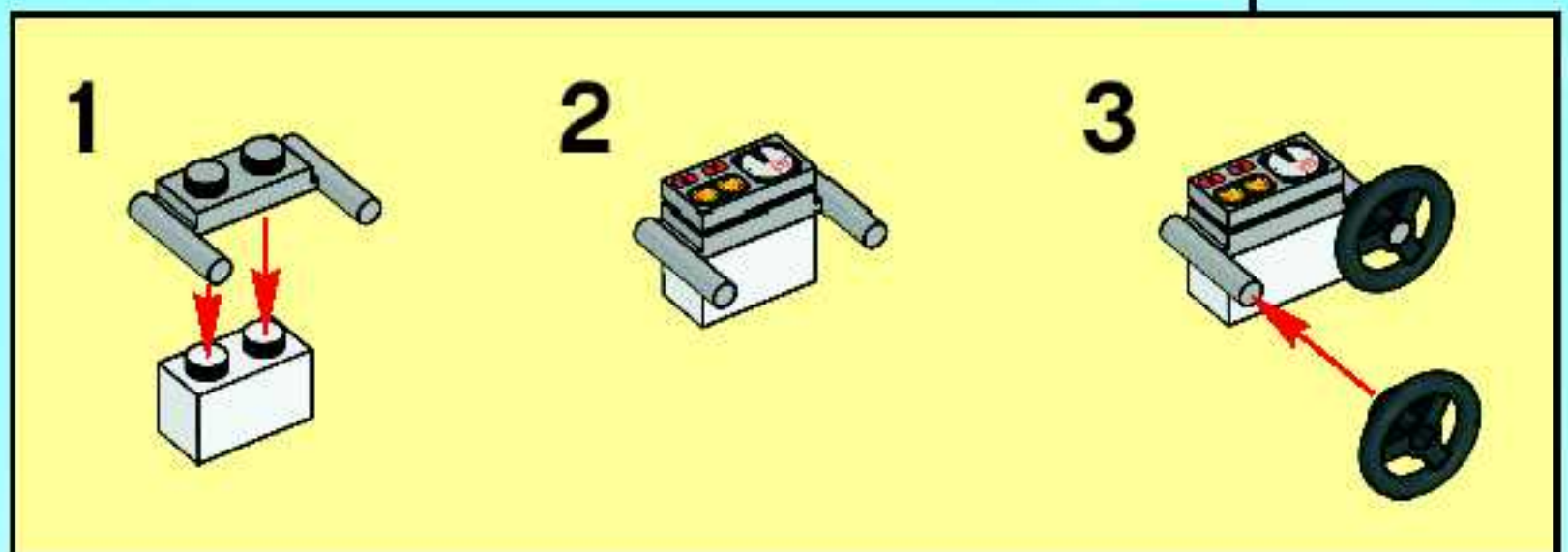
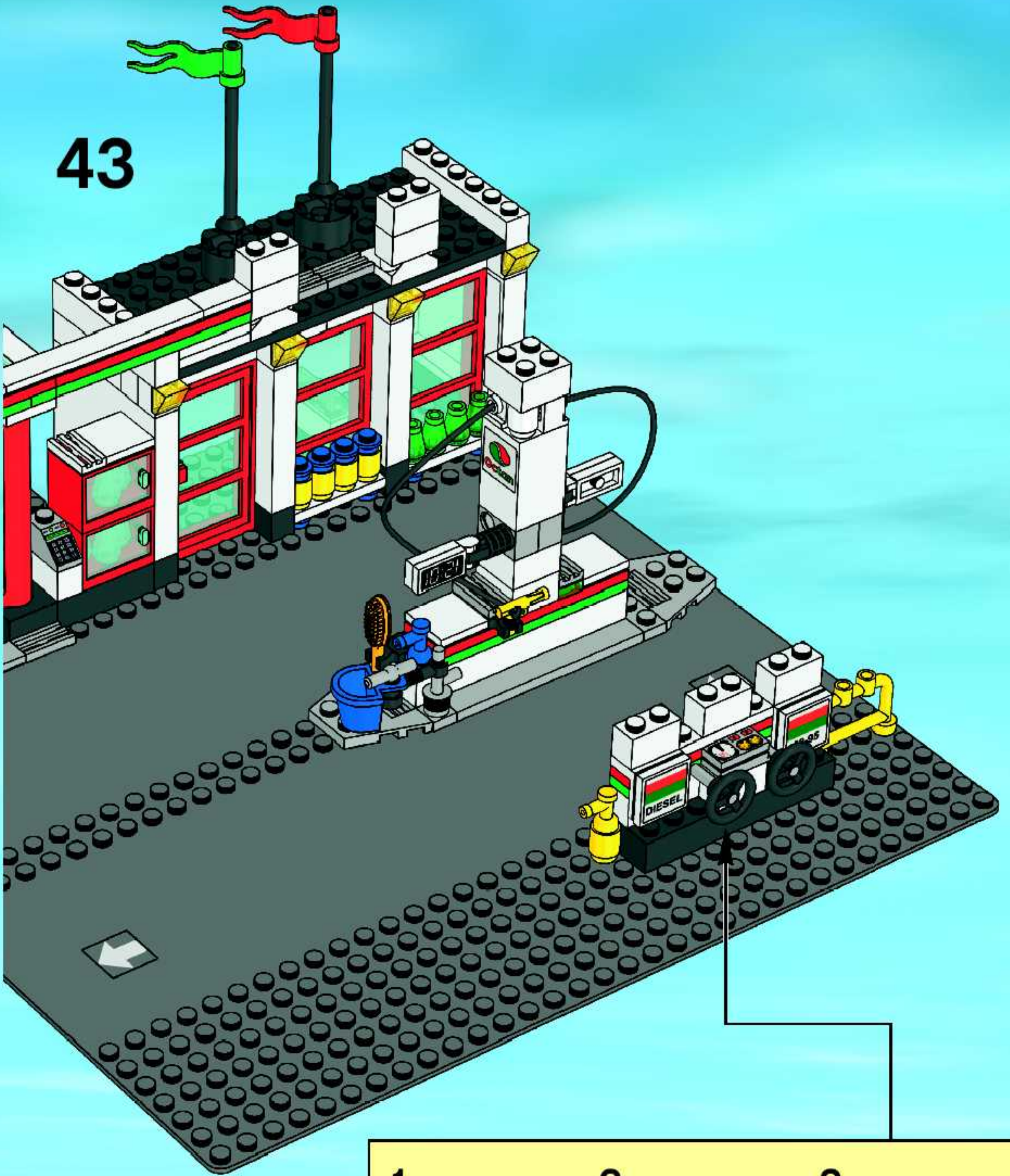



44

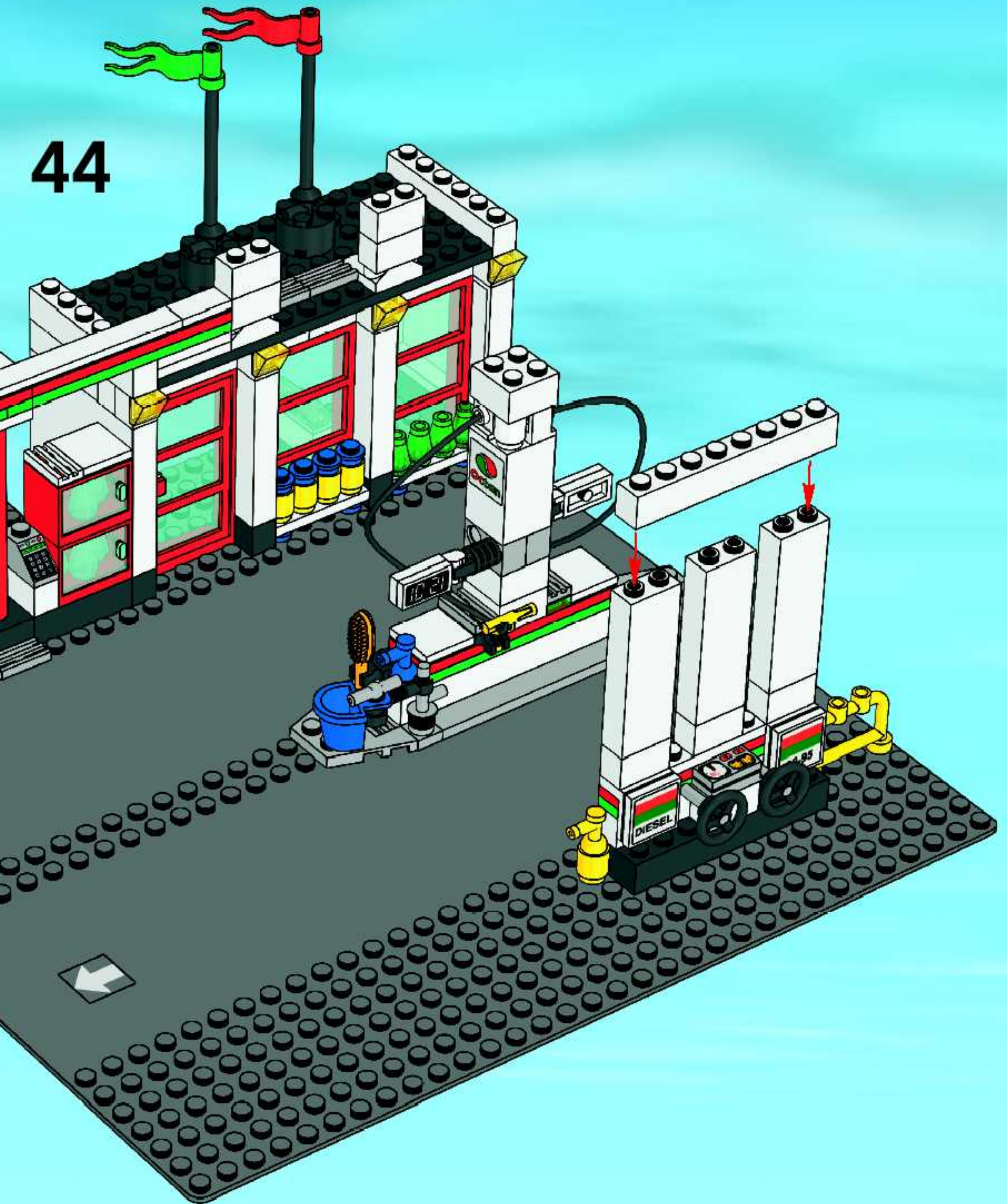



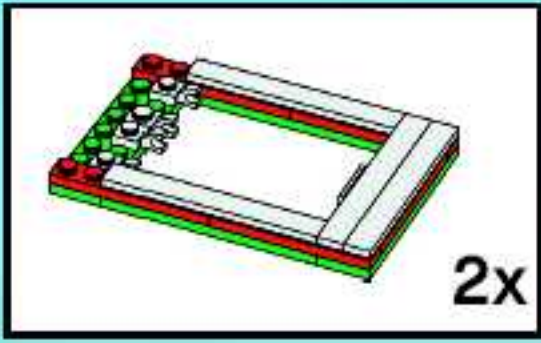
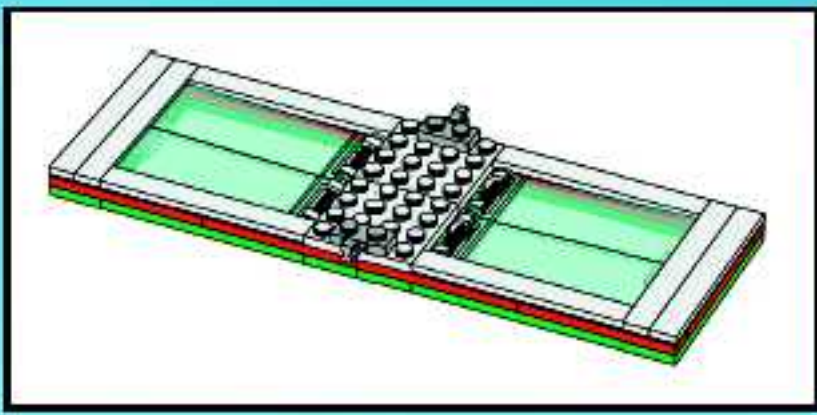

1

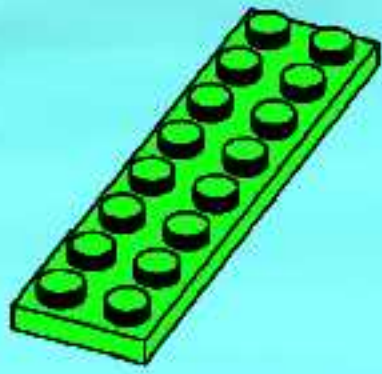

3

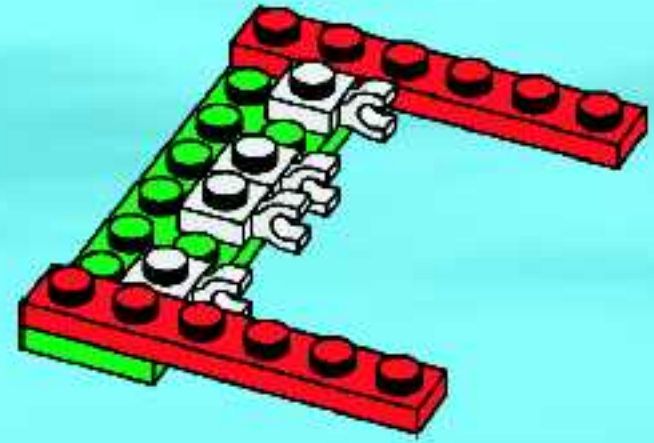

2

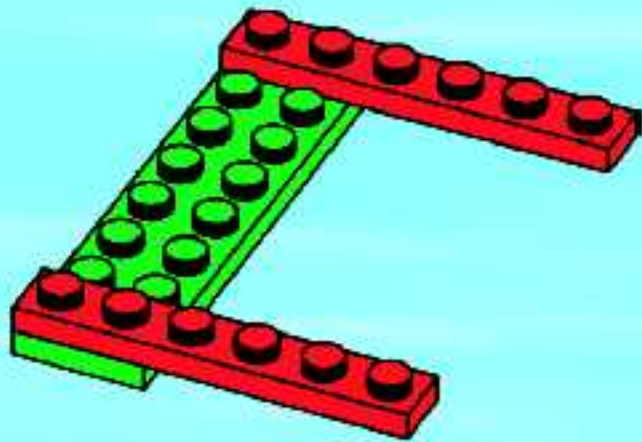

4

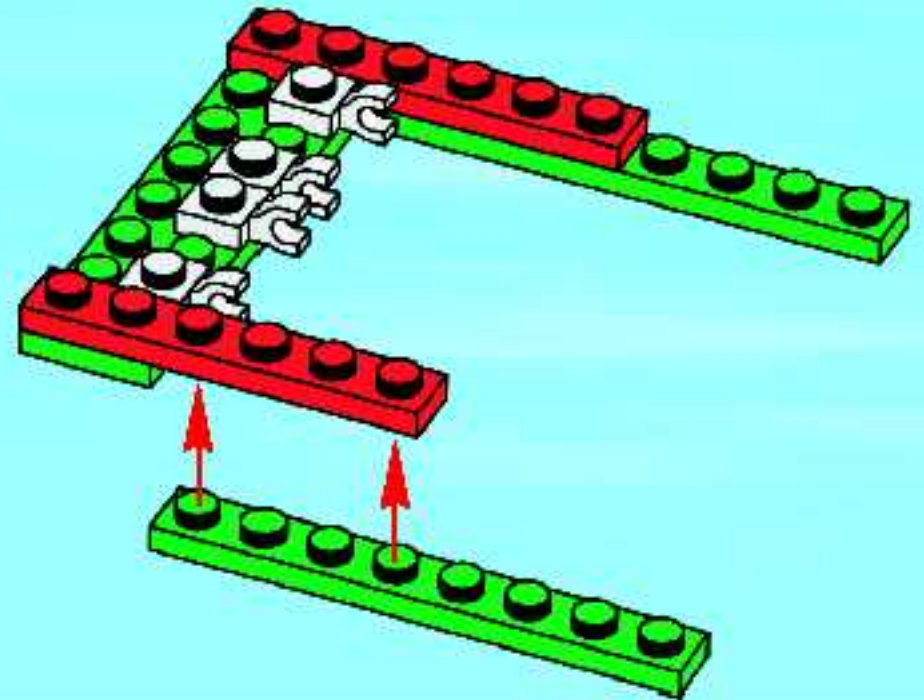



5

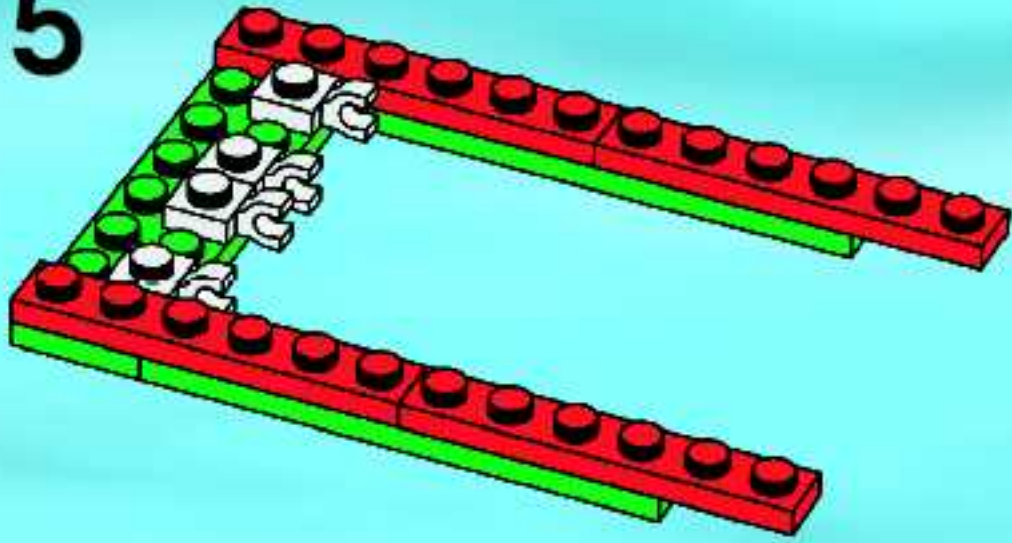

7

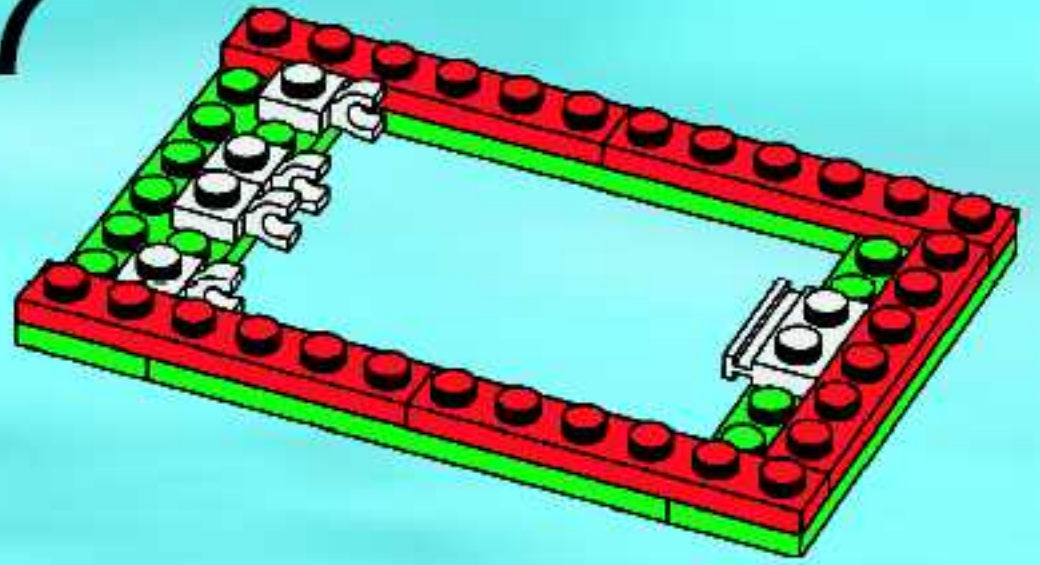

6

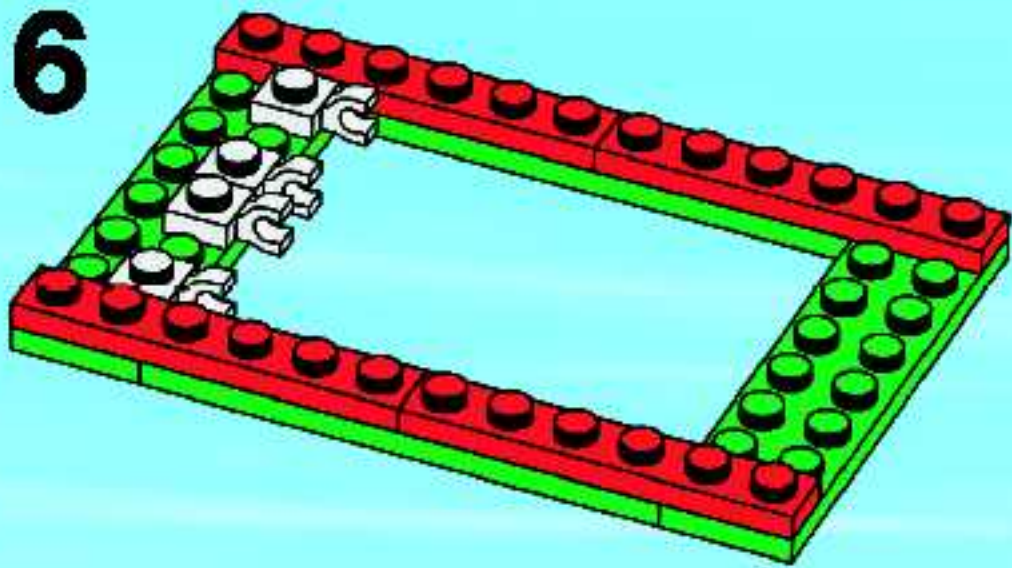

8

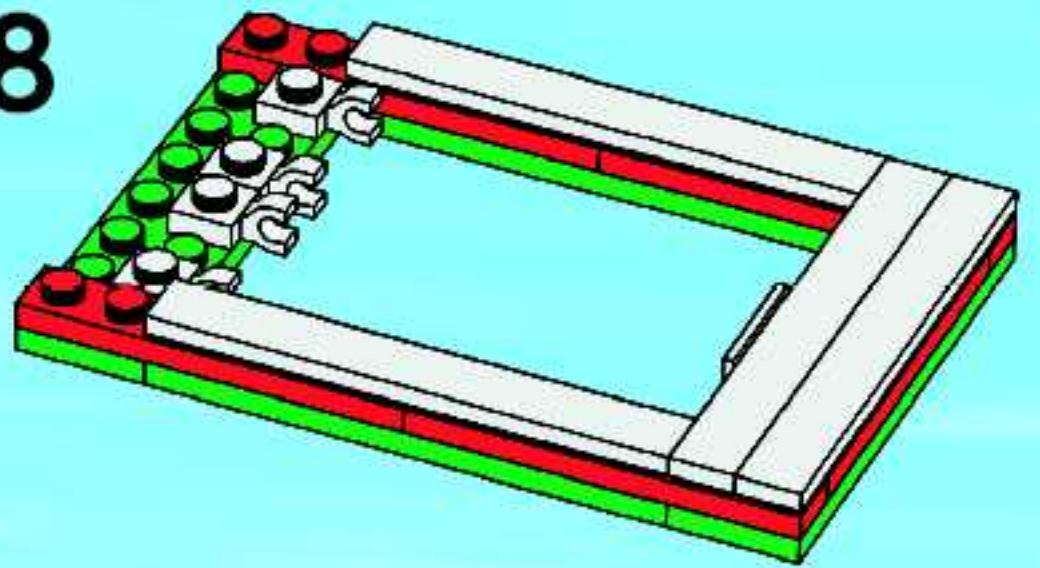

2x



9

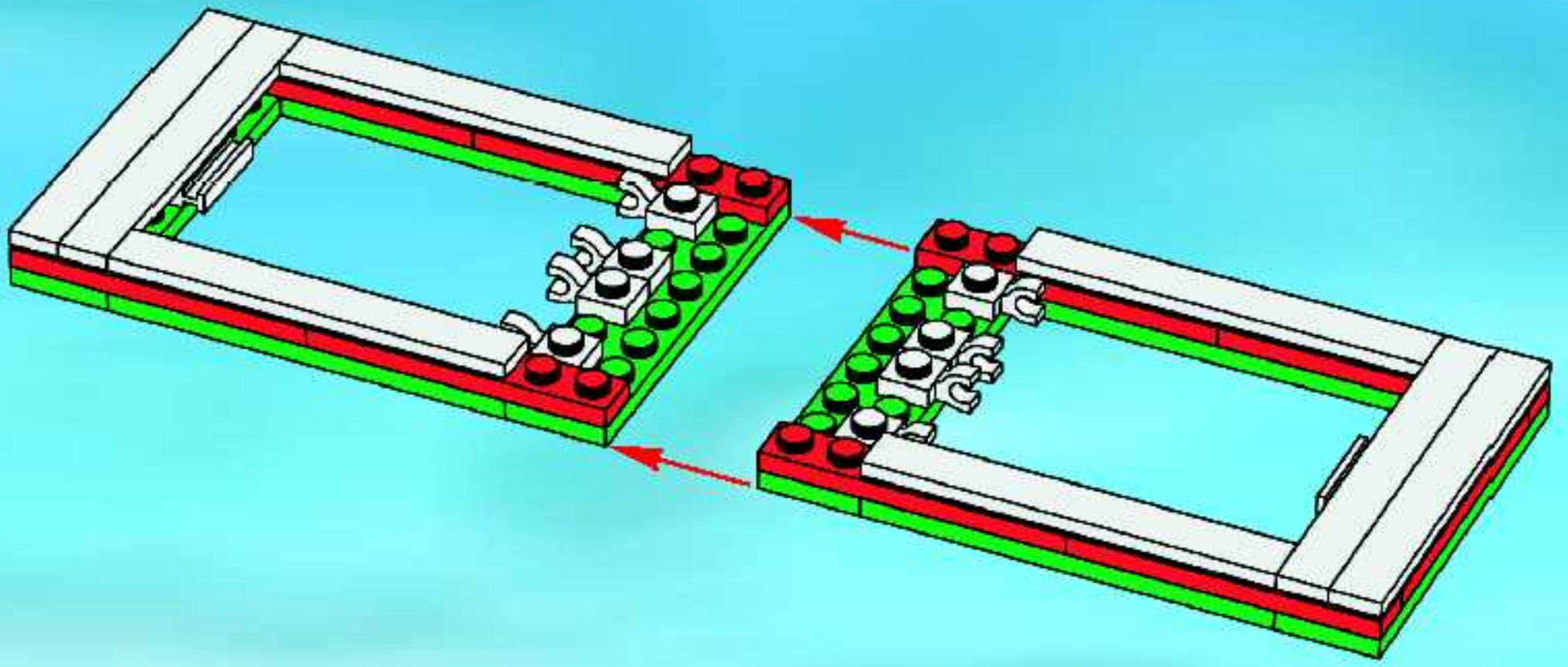

10

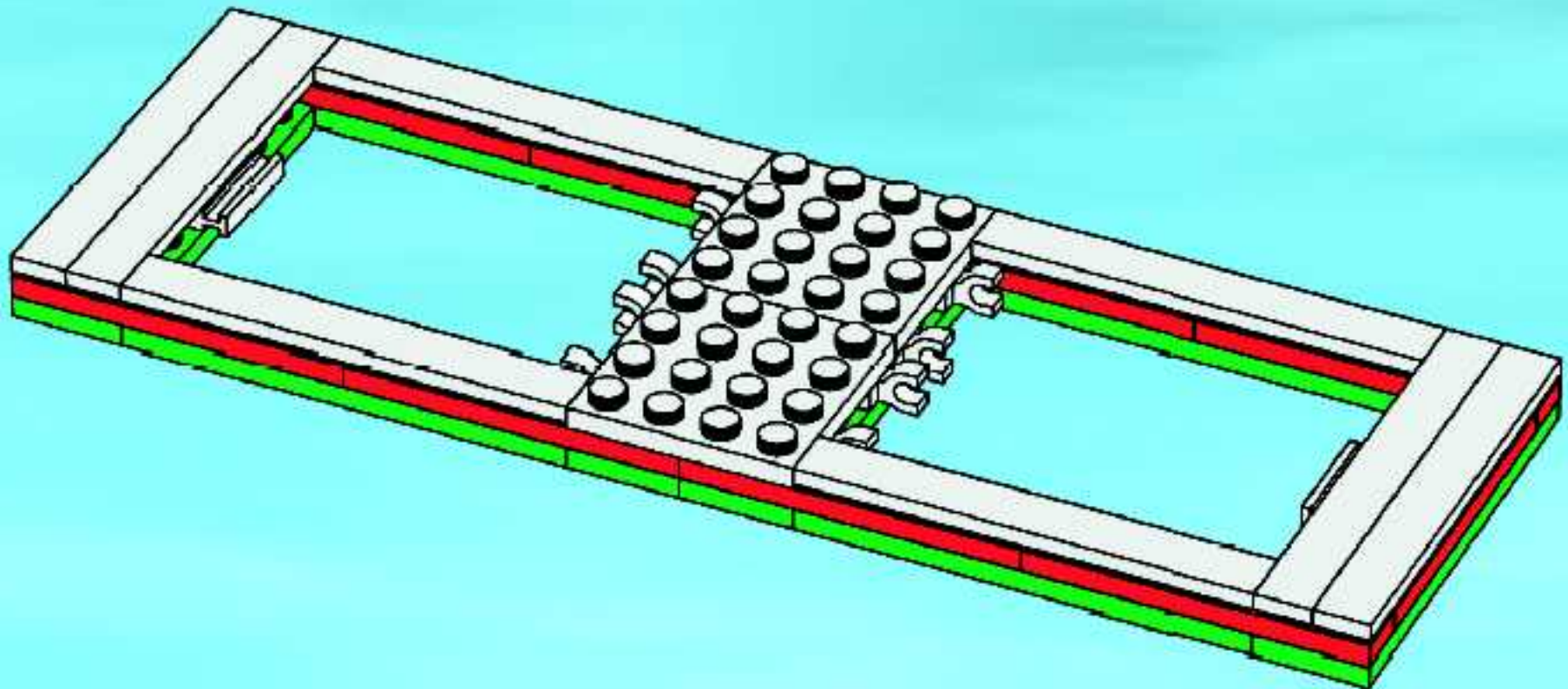

11

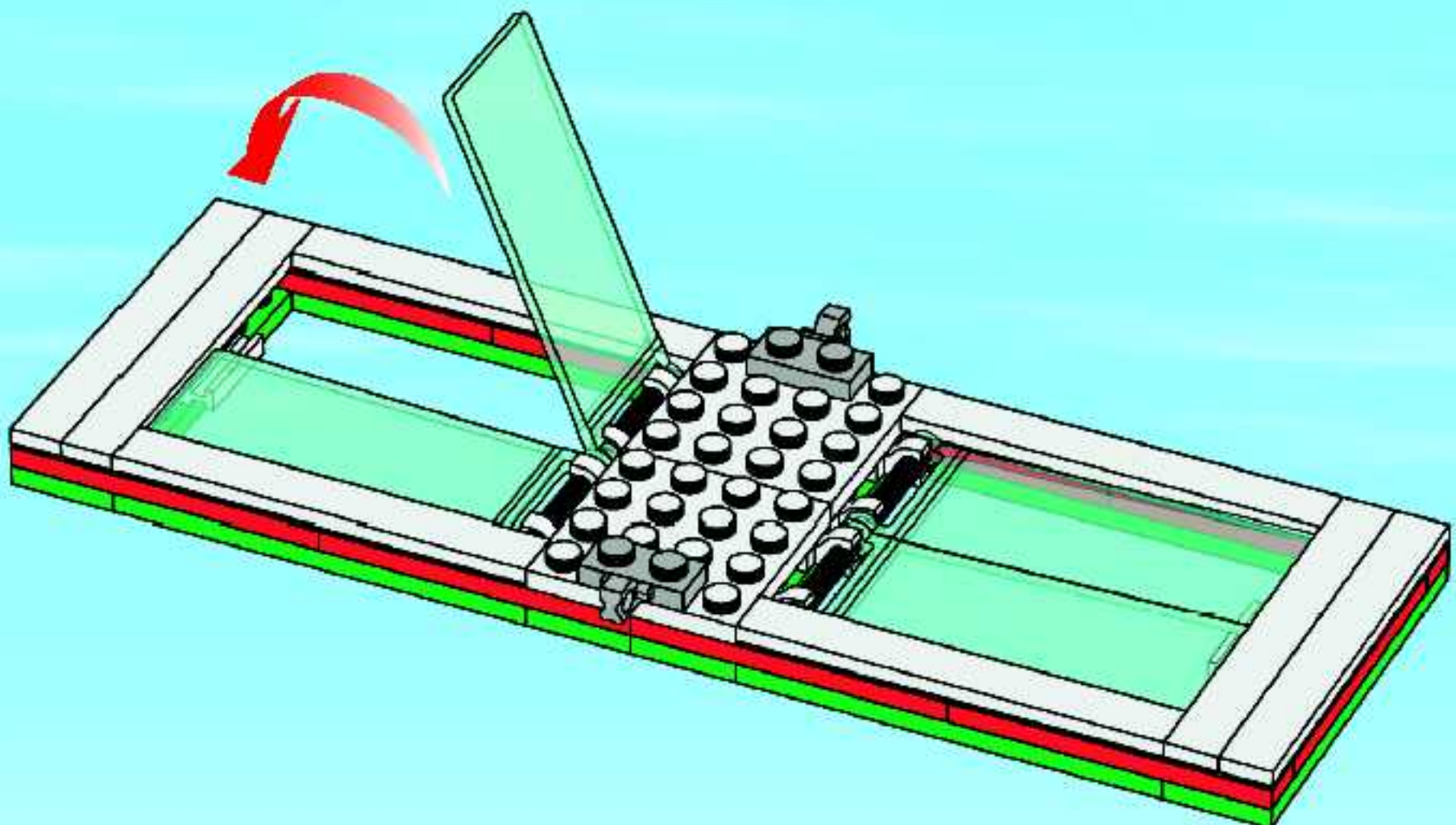



45

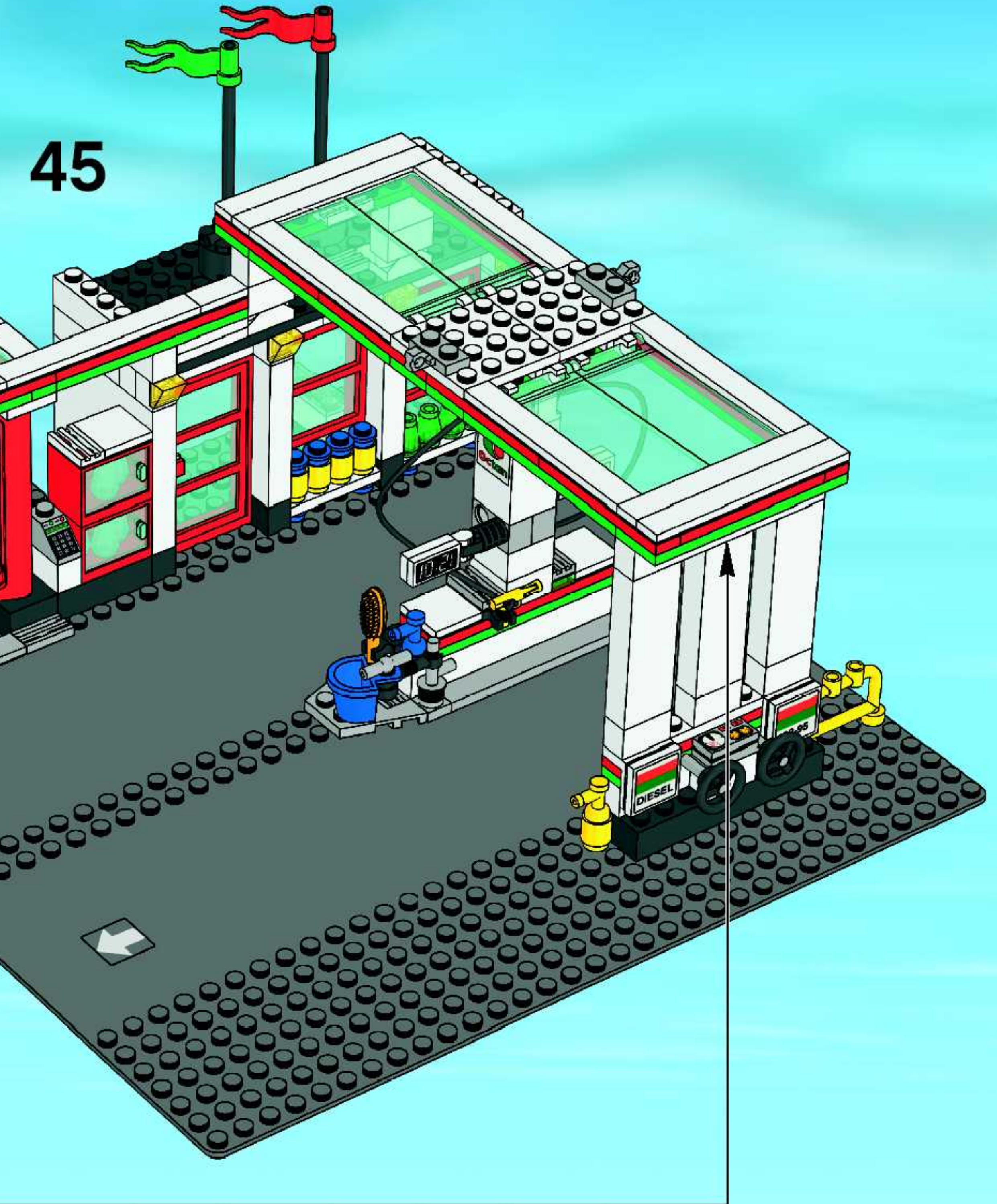



46

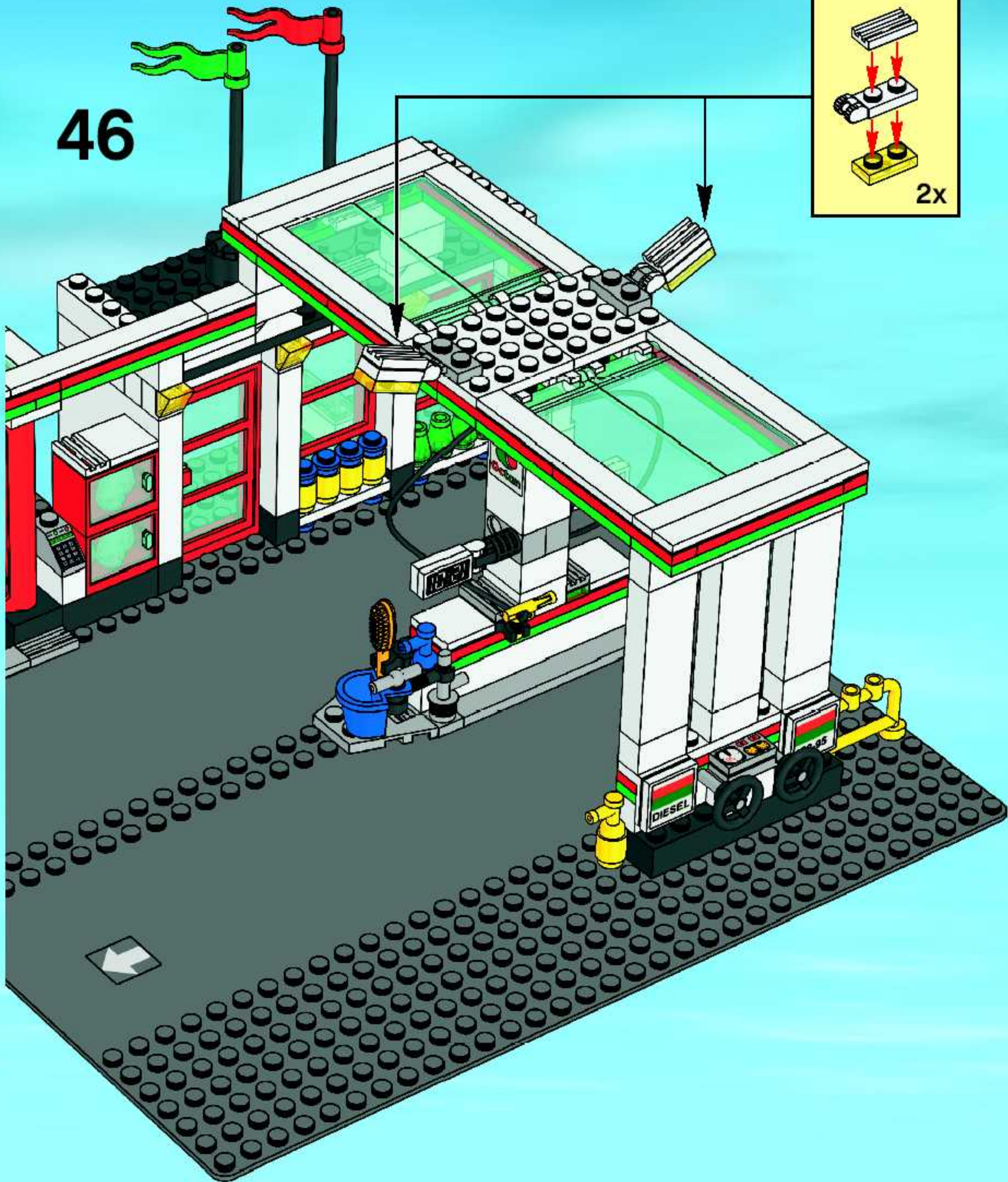
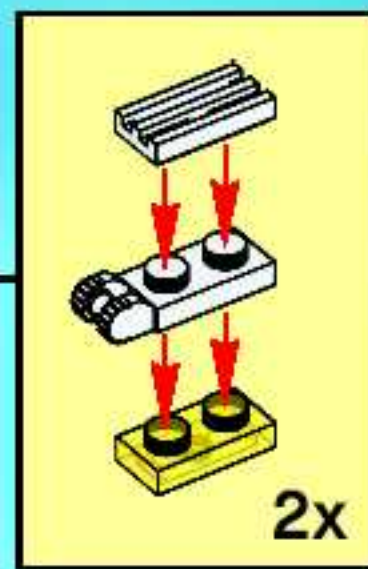



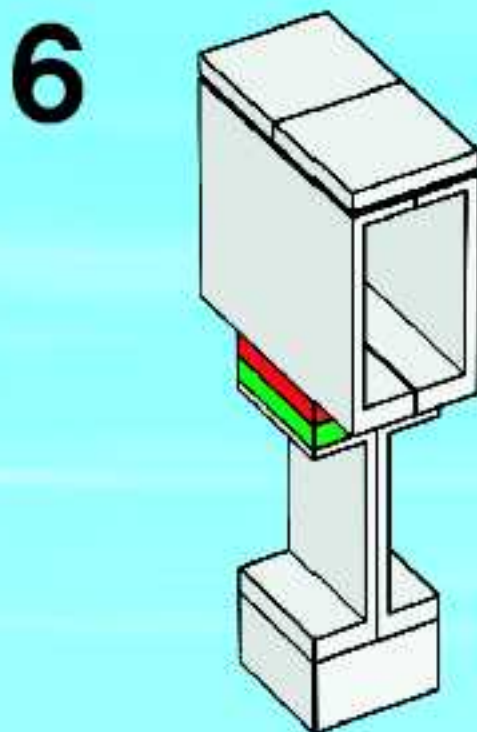
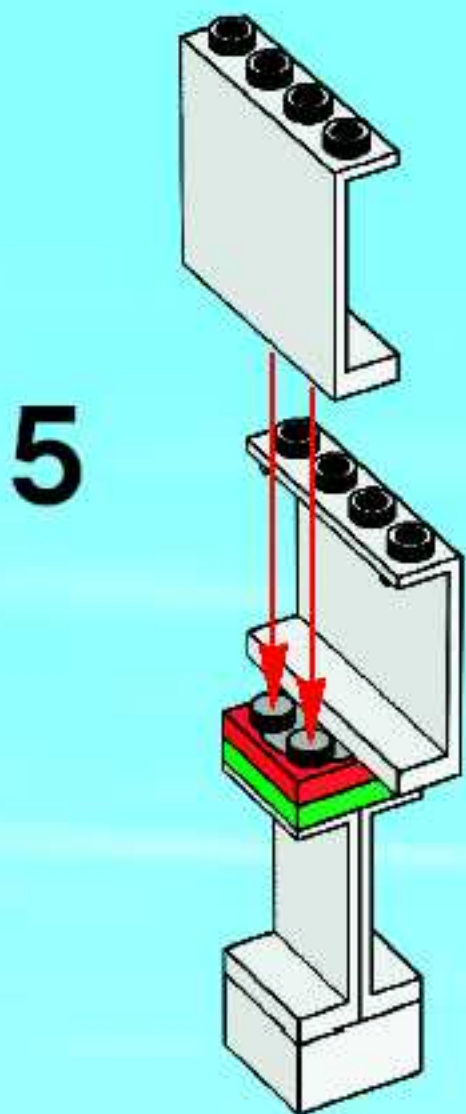
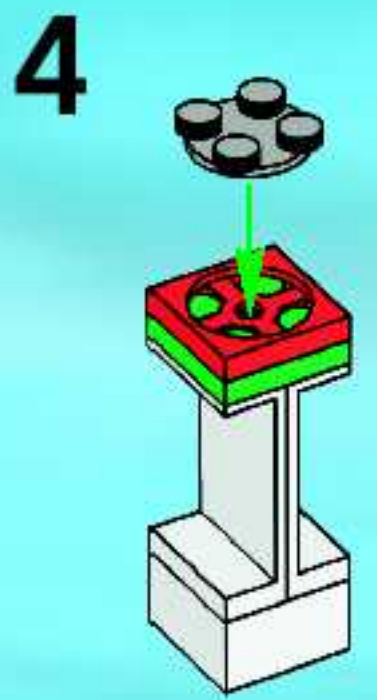
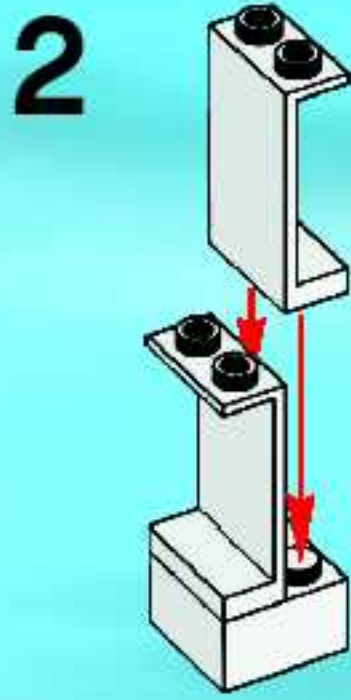
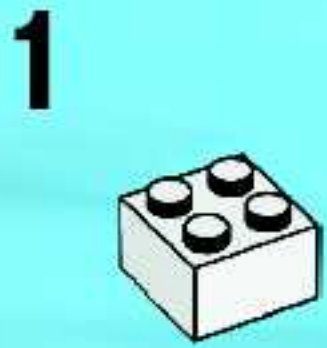
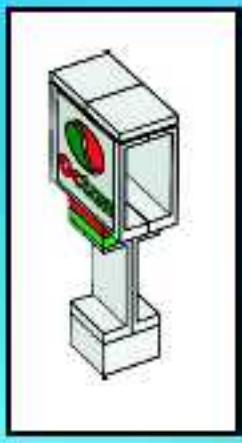



47

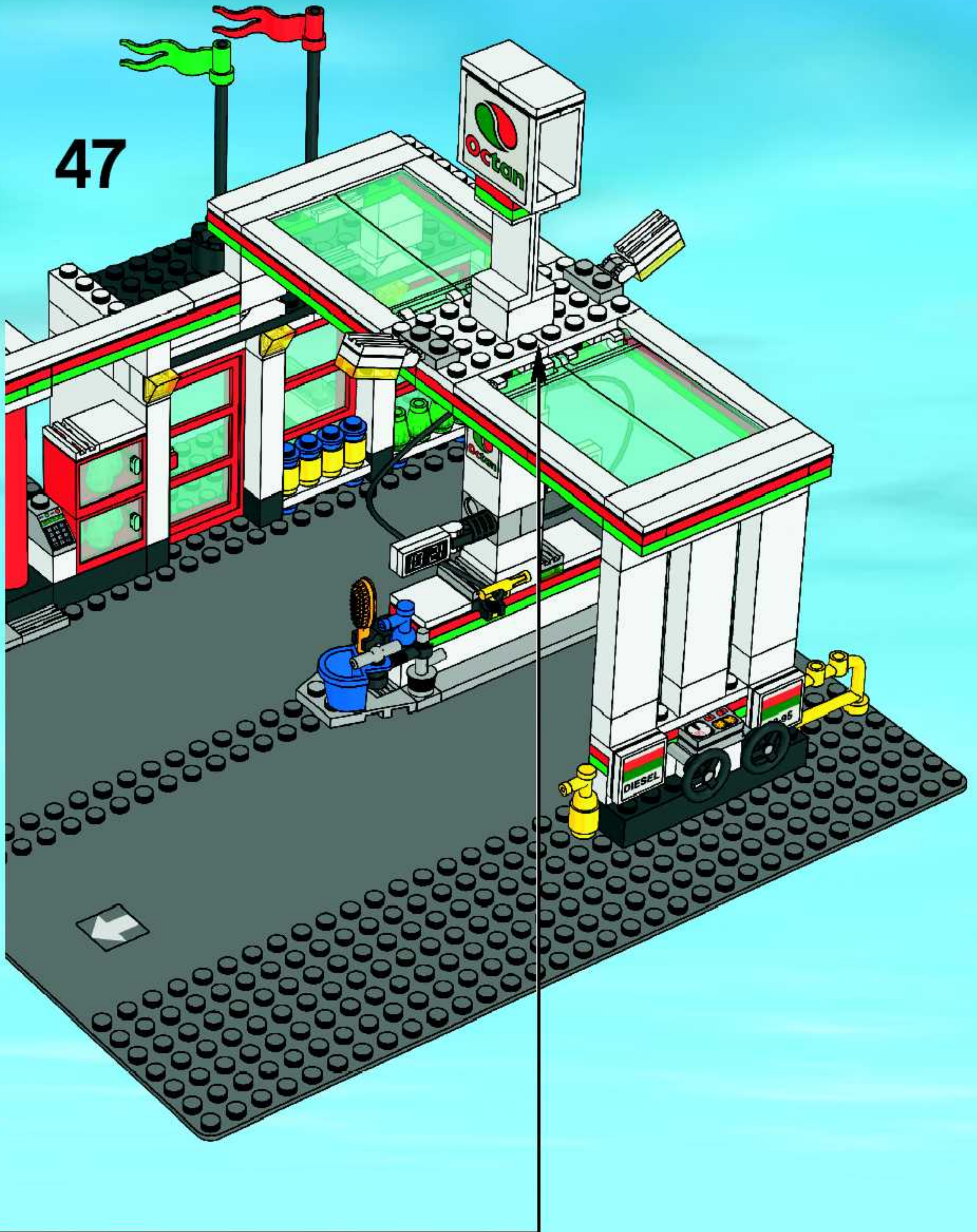



48

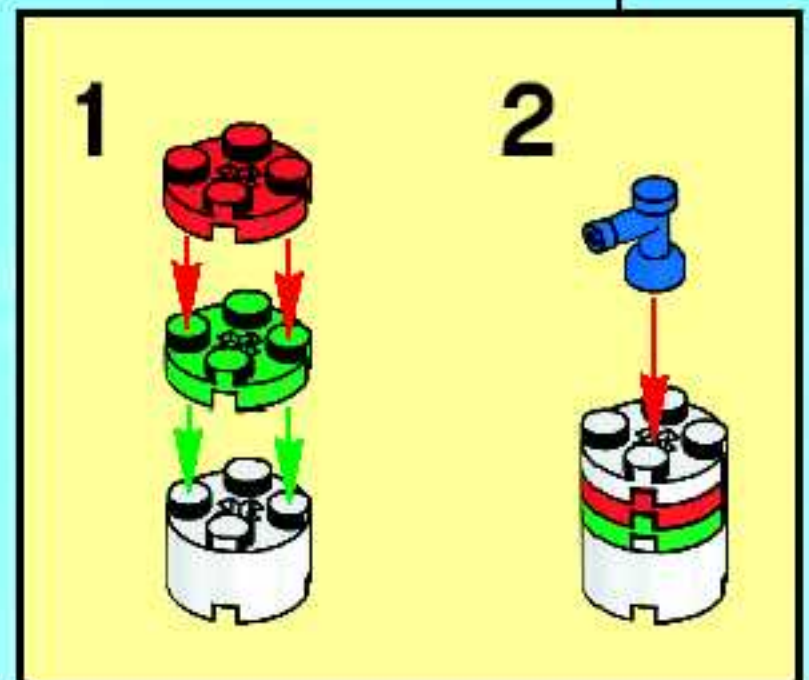
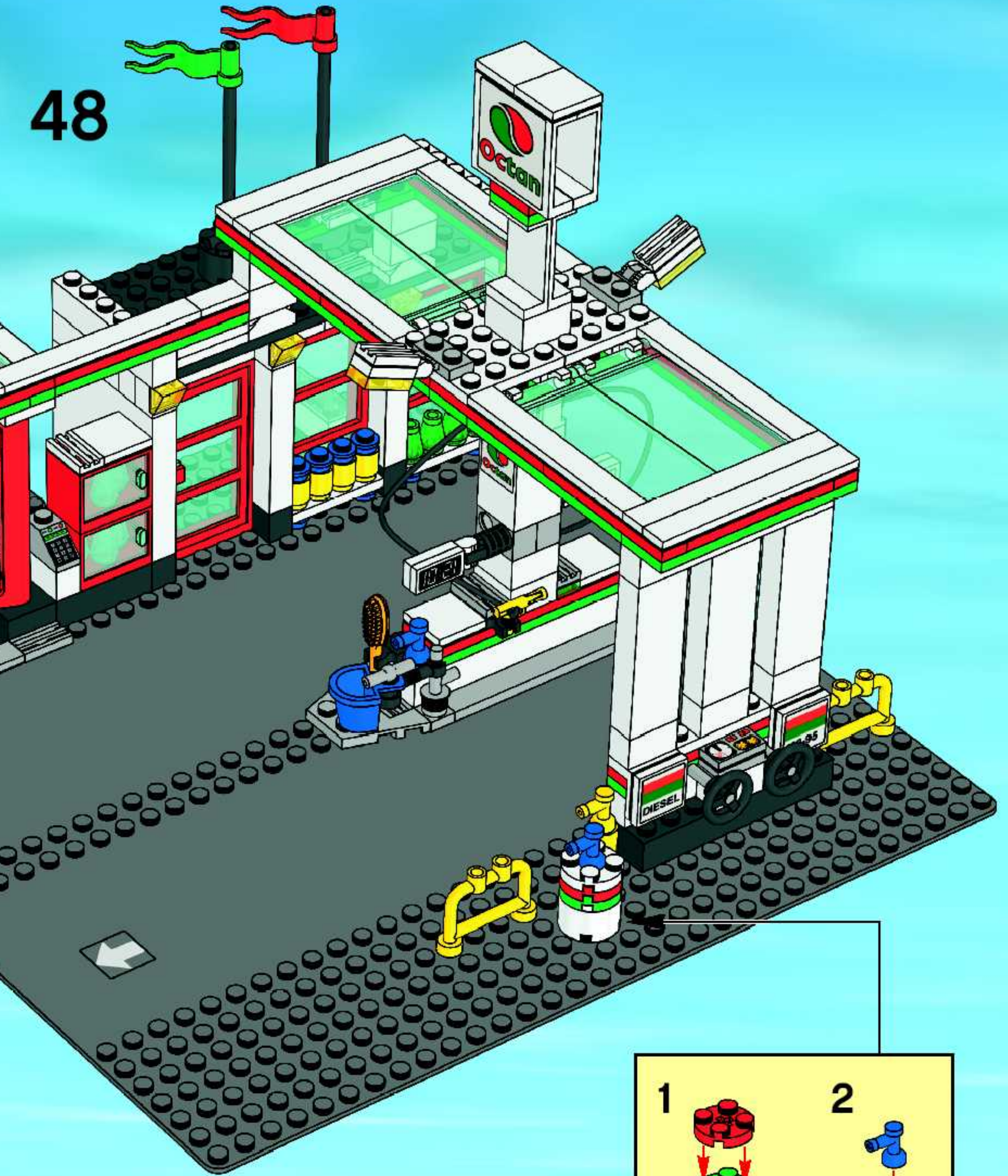



49

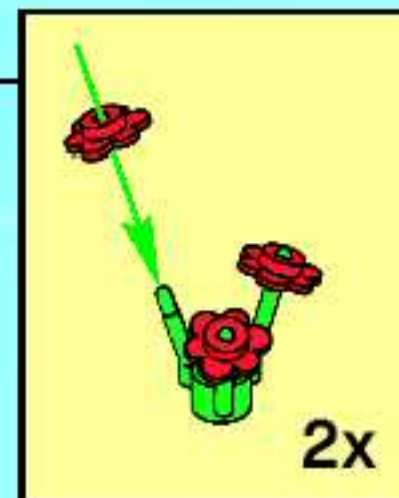
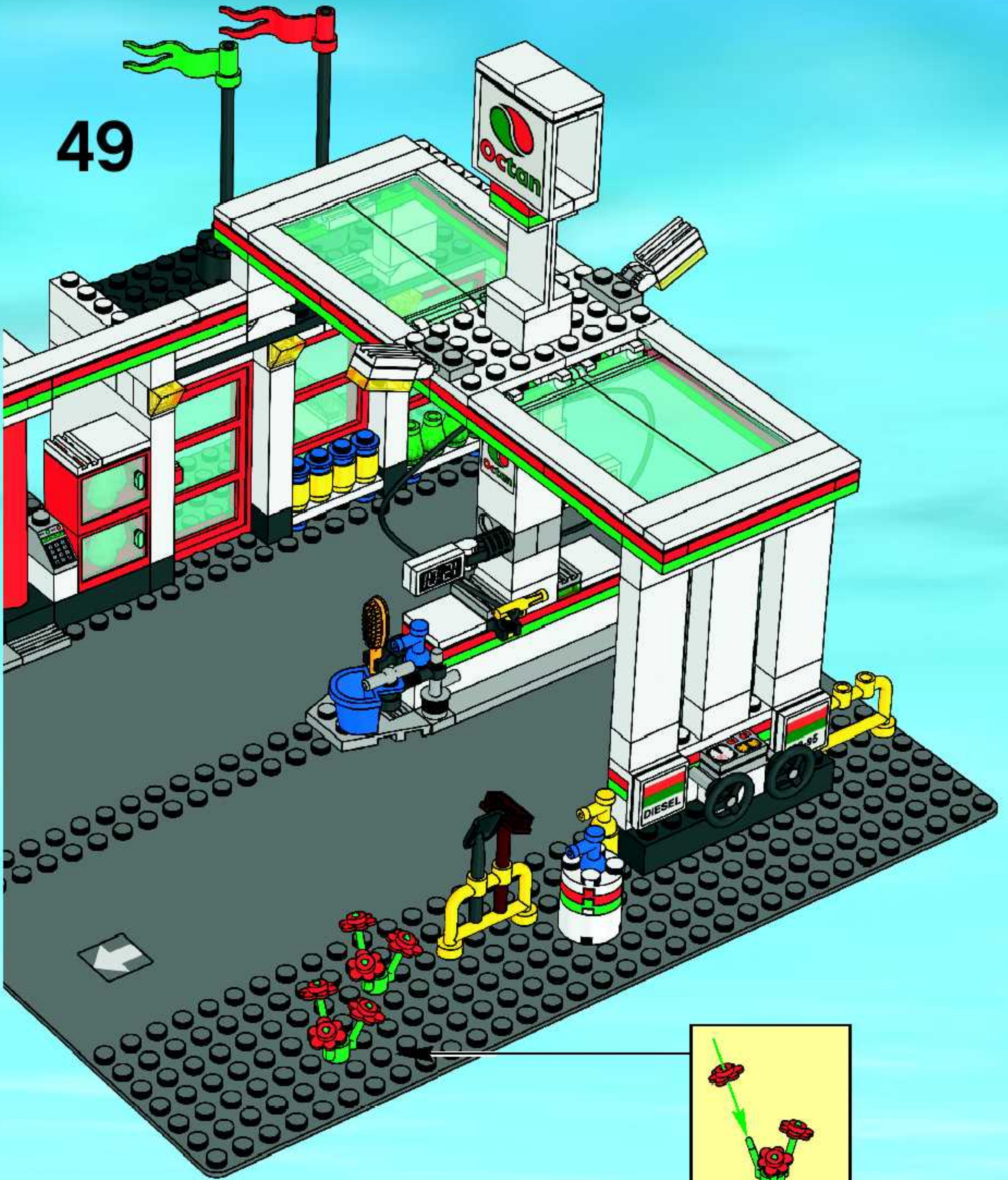



1

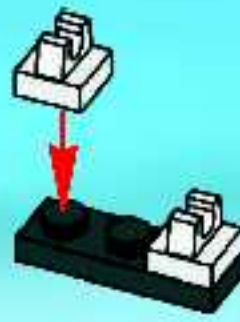

2



3

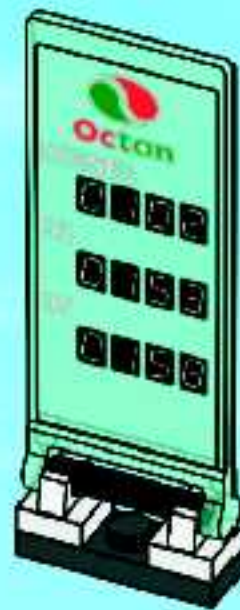



50

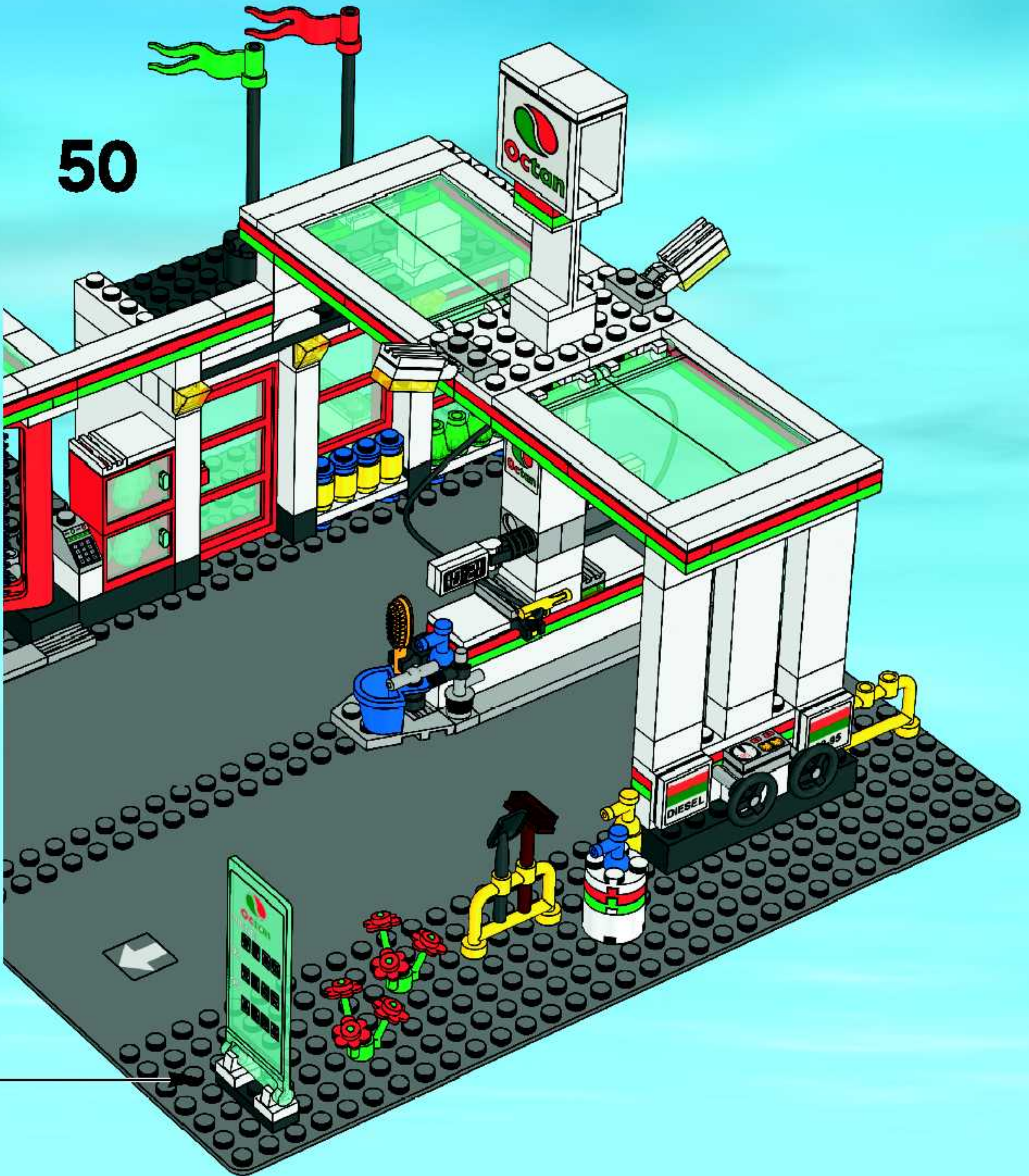



51

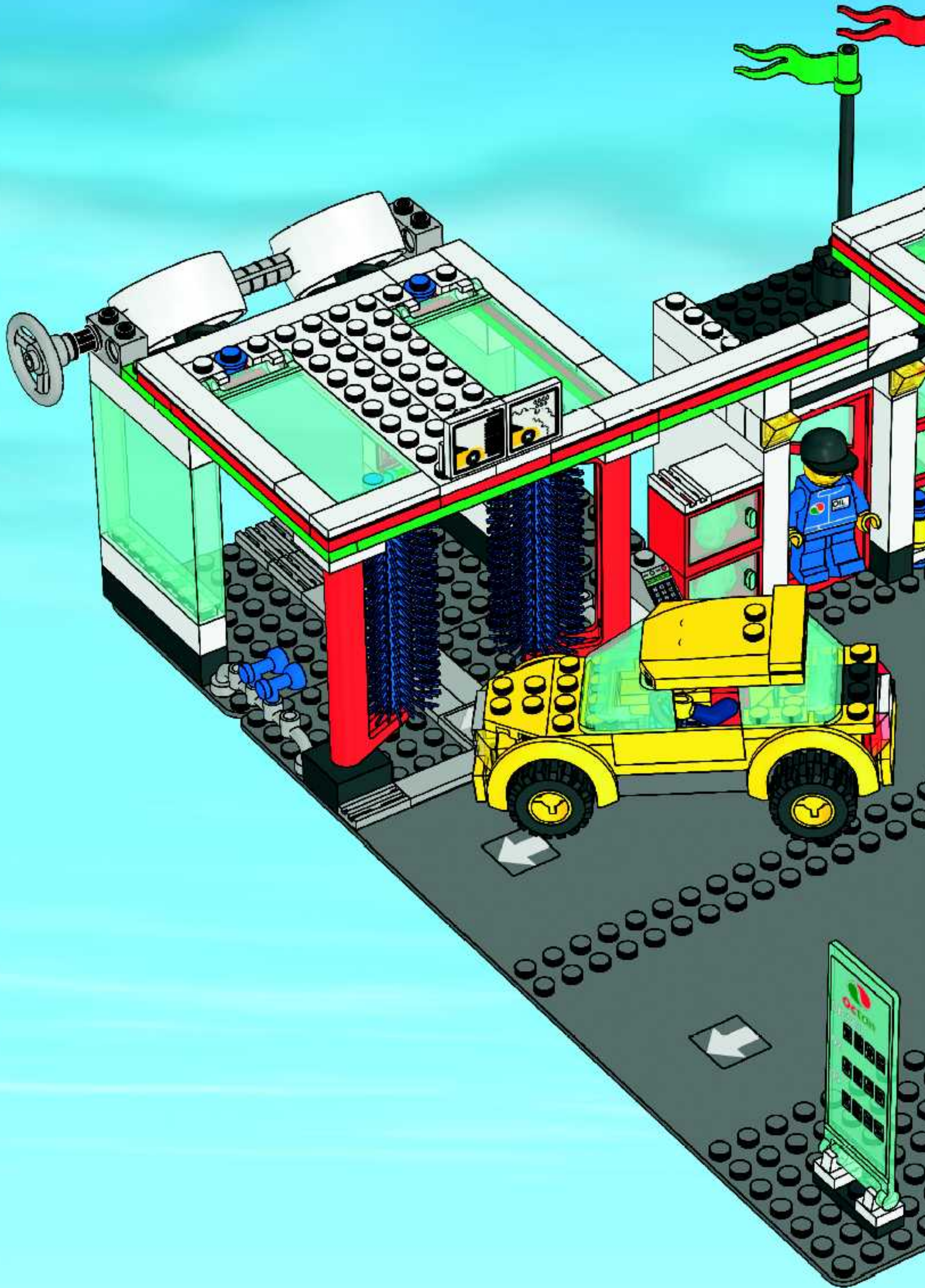







- 2x 4277926
- 1x 4282737
- 8x 407001
- 13x 300401
- 5x 245401
- 6x 300901
- 6x 300801
- 4x 300301
- 1x 4109791
- 1x 614301
- 6x 306901
- 2x 81268
- 1x 243101
- 12x 416201
- 9x 306801
- 2x 255501
- 12x 601901
- 4x 4183048
- 2x 4249563
- 2x 362301
- 3x 371001
- 2x 383201
- 2x 4293876
- 1x 403201
- 2x 4243812
- 2x 4494474
- 3x 241201
- 1x 4195657
- 2x 366001
- 2x 306201
- 2x 4289534
- 2x 4113022
- 2x 4105202
- 2x 4504228
- 1x 4142865
- 2x 453221
- 1x 4285252
- 1x 4289298
- 2x 4503169
- 1x 448521
- 1x 4275868
- 1x 4275870
- 2x 4106915
- 2x 302321
- 3x 371021
- 10x 366621
- 1x 348021
- 1x 4255035
- 1x 403221
- 2x 241221
- 2x 4508233
- 1x 449521
- 1x 368021
- 4x 4244363
- 6x 4496119
- 2x 4206482
- 1x 9566
- 1x 9341
- 1x 4275827
- 1x 4186464
- 11x 614123
- 6x 459923
- 1x 4163306
- 5x 4296201
- 1x 4200798
- 1x 4243668
- 2x 4222960
- 1x 4211157
- 7x 4508534
- 2x 4218499
- 2x 4500813
- 2x 4505000
- 1x 4498374
- 1x 4228126
- 3x 4503535
- 6x 346028
- 2x 302328
- 1x 302228
- 1x 403228
- 5x 303428
- 2x 374128
- 1x 449528
- 4x 618848
- 2x 4217436
- 1x 4244573



1x  
4194017

1x  
4200908

1x  
4261572

2x  
4515896

3x  
371024

1x  
302024

1x  
4260192

1x  
4193073

4x  
4170460

5x  
306224

1x  
4256320

2x  
4503844

2x  
4171666

2x  
4288592

4x  
4288594

3x  
243124

2x  
408324

2x  
4194746

7x  
4260942

1x  
70905

2x  
4508536

2x  
300126

1x  
300726

2x  
614326

1x  
4141580

1x  
4288018

2x  
384926

1x  
4189009

1x  
448526

1x  
4492322

1x  
4242385

3x  
408526

2x  
379426

1x  
362326

2x  
302226

2x  
300426

4x  
300926

1x  
4140801

2x  
604126

2x  
4153044

2x  
4159335

4x  
4514560

2x  
4244953

1x  
4500577

1x  
4222693

2x  
4503176

1x  
4259673

3x  
4211481

1x  
4211413

2x  
4211524

1x  
4211464

1x  
4227657

2x  
4211814

2x  
4211445

2x  
4240013

1x  
4215405

1x  
4211439

2x  
4211569

4x  
4211541

13x  
4211350

2x  
4259653

1x  
4228198

1x  
4211578

3x  
4211508

1x  
4261357

3x  
4211807

1x  
4211543

1x  
4227776

1x  
345626

1x  
4226978

1x  
4507668



# Win! Gagne! 当たります Gewinne!

## Win LEGO products

We would like to know what you think about your new LEGO product. Log on to the web address below for further instructions.

## Gagne des produits LEGO

Nous aimerions savoir ce que tu penses de ton nouveau produit LEGO. Tu obtiendras davantage d'informations en visitant le site Internet indique ci-dessous.

## Gewinne LEGO produkte

Wir sind sehr an deiner Meinung über dein neues LEGO Produkt interessiert. Gehe einfach zu der unten angegebenen Webadresse – dort findest du weitere Informationen.

## Estimado usuario LEGO

Al contestar algunas preguntas en inglés, francés, alemán o japonés, en el sitio [www.acnielsen.aim.dk/lego](http://www.acnielsen.aim.dk/lego), podrás participar en el sorteo de algunos valiosos premios LEGO.

## Caro Consumidor da LEGO

Ao responder a algumas perguntas em Inglês, Francês, Alemão ou Japonês no endereço [www.acnielsen.aim.dk/lego](http://www.acnielsen.aim.dk/lego) irá participar num concurso para ganhar valiosos prémios da LEGO.

## Kedves ifjú LEGO Vásárló

Ha ellátogatsz a [www.acnielsen.aim.dk/lego](http://www.acnielsen.aim.dk/lego) honlapra és ott angol, francia, német vagy japán nyelven megválaszolsz néhány kérdést, akkor részt veszel egy versenyben, amelyben értékes LEGO díjakat nyerhetsz.

## 抽選でレゴ®製品が当たります

私たちは、皆さんがお買い求めのレゴ®製品についてどんな感想をお持ちか、知りたいと思っています。質問に答えて、楽しいレゴ製品の抽選に応募しませんか。アンケートの回答には、ほんの3分ほどしかかかりません！詳しくは、以下のウェブアドレスまでアクセスしてください。



[www.acnielsen.aim.dk/LEGO](http://www.acnielsen.aim.dk/LEGO)



Any questions regarding your new LEGO product, please contact:

**Customer Service | Kundenservice**

**Service Consommateurs**

**Servicio Al Consumidor at**

**[www.lego.com/service](http://www.lego.com/service) or dial**

              :

**00800 5346 5555**

  :

**1-800-422-5346**





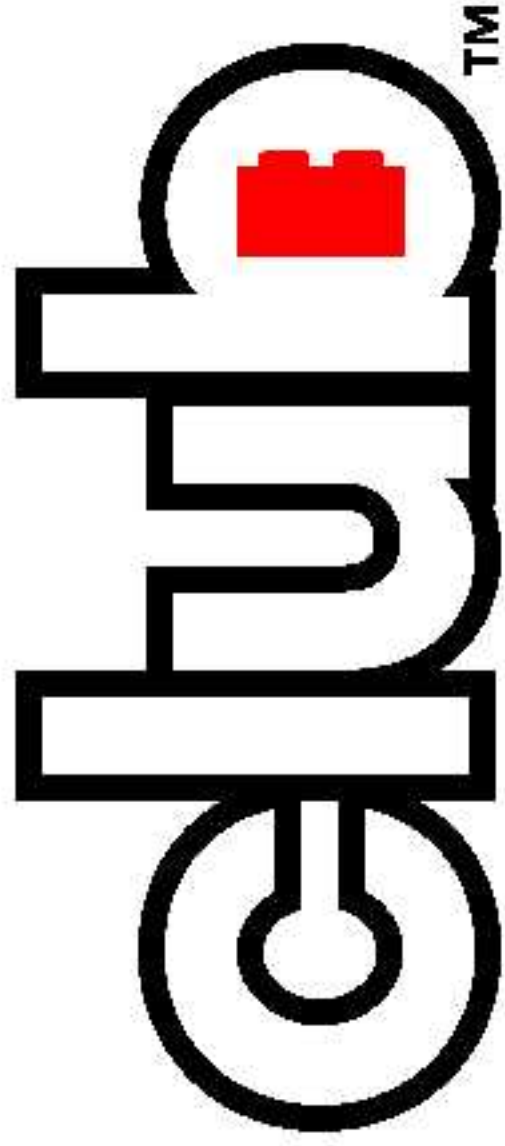



TM

FREE LEGO Magazine • GRATUIT • GRATIS LEGO Magazin



**Join Today!**  
 .....  
**Abonne-toi**  
**dès aujourd'hui!**  
 .....  
**Meld je nu aan!**  
 .....  
**Jetzt anmelden!**

  US & Canada only  
 1-866-534-6258 / 1-877-518-5346  
(en Français)

       
 00800 5346 5555

[www.LEGOclub.com](http://www.LEGOclub.com)



VISIT THE  
**WORLD'S BIGGEST  
 LEGO® SHOP!**  
[www.LEGOshop.com](http://www.LEGOshop.com)









# CITY



7990



7991



7992



7993



7994





7241



7842



7238



7239



7845



7944









©2007 The LEGO Group. 4516695



CITY



7246



7242



7248



7905



7249