



造型 飲食 品味

“即使你还没有准备好
尽情体验生活，
可以先尝试一部分，
然后完全沉浸其中。”

- 鲍比·伯克

粉雄救兵

不仅仅是改造

尽管很多真人秀节目以击垮人为目的，但《粉雄救兵》旨在帮助人们重拾信心。神奇五人组（Fab Five）利用自己正反两方面的个人经历，为他们碰到的每个人（团队更愿意称他们为英雄）带去建设性和持久的影响。

与神奇五人组小人仔们一起来到他们的乐高®版亚特兰大阁楼。他们都在这里了：时装设计师谭·法郎士、礼仪文化专家卡拉莫·布朗、美食与美酒专家安东尼·波罗夫斯基、室内设计师鲍比·伯克和美容顾问乔纳森·凡·奈斯。他们需要你的帮助，以展现他们的最新改造成果。祝你玩的开心！



“作为一名造型师，我的目标是帮助人们成为最出色的自己。”

- 谭·法郎士



谭·法郎士

时装设计



谭·法郎士出生于英格兰南约克郡唐卡斯特，父母是巴基斯坦人，于 2008 年开始在美国工作，现住在美国犹他州盐湖城。作为一名服装设计师和时尚专家，谭通过告诉人们如何穿戴令自己感觉良好来帮助他们重拾信心。很多时候，他完成一项神奇的改造时，会采用他标志性的“法式塞 (French Tuck)”！



“在一个艰难的世界里，食物
可以带来纯粹的情感享受。”

- 安东尼·波罗夫斯基

安东尼·波罗夫斯基

美食美酒

安东尼出生于波兰移民家庭，在加拿大蒙特利尔长大，能够讲波兰语、英语和法语三种语言。他移居美国后，开始学习心理学和戏剧，之后转向烹饪。在加入神奇五人组并鼓励人们开始自己做饭之前，他为 Ted Allen 工作，后者是 21 世纪初《粉雄救兵》节目的美食专家。



卡拉莫·布朗

礼仪文化

卡拉莫·布朗是团队的生活教练和治疗师。他帮助节目的英雄们了解自己，鼓励他们克服自己所面临的人生逆境。卡拉莫出生于美国德克萨斯州休斯顿，具有牙买加和古巴血统，现与他的两个儿子住在洛杉矶，是黑人 LGBT 群体的积极活动家。



“不是生活决定你，
而是你决定生活。”

- 卡拉莫·布朗





“当你在家里快乐时，
会把快乐带到生活的
每个角落。”

- 鲍比·伯克



鲍比·伯克

室内设计

鲍比在美国密苏里州的一个小镇上长大。2003年，他移居纽约，当时口袋里只有100美元。在推出自己的网店之前，鲍比凭借自己的努力，成为一家装修公司的创意总监。在Netflix的《粉雄救兵》节目中，鲍比改造了英雄们的生活空间，帮助他们改变自己的生活。

“你怎样对待自己，世界就会怎样看待你。”

- 乔纳森·凡·奈斯



乔纳森·凡·奈斯

美容美发

作为神奇五人组满怀热情的啦啦队长，乔纳森鼓励节目的英雄们通过自己个性化的梳妆和自我护理时刻找到一些真正的“自我时间”。不在《粉雄救兵》节目中美发时，乔纳森是一系列获奖播客的热情主持人，还是体操和花样滑冰的超级粉丝，甚至有人传言乔纳森本人已经掌握了在冰上后外点冰跳和阿克塞尔跳！





Bruley 是一只可爱的法国斗牛犬，出现在第 3 和第 4 季中。他于 2019 年去世，我们现在以乐高®方式永远纪念他。

每位改造对象都是英雄

《粉雄救兵》中的每位英雄都有自己特别的故事。有些人面临着失去亲人的创伤，有些人需要战胜严重的疾病，有些人面临着家人的排斥，还有些人则为他人和周围的社区付出了很多，却几乎没有时间照顾自己。他们都是神奇五人组的英雄，都值得给予改造，使他们的生活更轻松、更健康、更快乐。

本周嘉宾

如果没有人被神奇改造，华丽转身，这款模型算不上一款真正的粉雄救兵乐高®套装！大家认识一下 Kathi Dooley，她是一位非常热心的

老师，在乔纳森的早期生活中扮演了特殊的角色，用理解和宽仁支持他。现在是乔纳森和他的朋友们报答师恩的时候了.....

Kathi Dooley
乐高版改造



妆扮前

妆扮后

鲍比拥有很酷的设计技能，他从小就开始培养了……
使用乐高®套装！



不仅仅是 改造

真正的团队协作！

设计这款粉雄救兵乐高®套装得益于乐高设计团队与电视节目中设计大师鲍比·伯克之间的神奇五人组风格的真诚合作。对鲍比而言，它很快成为了一个充满激情的项目：“乐高在我的童年里有着举足轻重的作用。拼搭这些小小的积木确实激发了我的想象力和创造力。”乐高设计副总裁 Matthew Ashton 将此次携手视为一次完美的合作：“我们在价值观方面拥有如此多的相似之处，如关爱、学习、创造力和乐趣。神奇五人组旨在重塑人们的生活，而我们的使命是激发孩子和成人的创造力，邀他们一起重建一个更加积极美好的世界。”

第一项任务是确定这款套装的确切内容。项目团队很快锁定了节目第一季中的阁楼场景，并一起确定了模型的平面图和布局。对于 Matthew 来说，他们捕捉到尽可能多的细节至关重要：“我们希望重现家具，以及标志性的细节，诸如‘STYLE、TASTE、CLASS’之类的标志。我们还希望为每位主持人设置一块独特的区域，以展现神奇五人组每位成员的独特技能和贡献。”

“能够与乐高团队合作绝对应
验了‘梦想成真’四个字！这
是任何孩子的梦想，现在在我
这里实现了。”

- 鲍比·伯克



鲍比和 Matthew 在设计初始阶段。



同心合力

就像神奇五人组一样，团队合作也是开发一款出色的乐高®套装的重要组成部分。Matthew 的乐高梦之队其他成员包括：高级美术设计师 Diego Sancho 和高级元件设计师 Ruth Kelly。

Diego 的重要职责是捕捉神奇五人组与其相应乐高小人仔之间的相似特征，以及设计所有装饰和贴纸，令阁楼跟真的一样：“我终于有机会亲自为阁楼设计艺术品，为粉丝们添加一些有趣的复活节彩蛋了！我设计了一幅带有 'Yaaas Queen' 字样的图画，以展现这一有趣的 LGBTQ+ 言论，并且如果仔细观看这幅独特的工笔画艺术，你会发现它表示 'FAB 5!' ”

Ruth 面临的挑战却大不相同：“在我们所有现有的带头巾的假发中，根本没有一个符合谭的蓬松发型，所以我的工作是在雕刻一个全新的。我们决定使用闪闪发光的银色塑料来注塑假发，以真正‘提升’谭的造型！”

Matthew 对这款成品套装和本次合作关系所代表的意义深感自豪：“神奇五人组已对许多人的生活产生如此积极的影响，我们需要花时间来彰显这种善举，而本次合作就是展示这一点的理想方式。”



从左至右：
高级元件设计师 Ruth Kelly
设计副总裁 Matthew Ashton
美术设计师 Diego Sancho



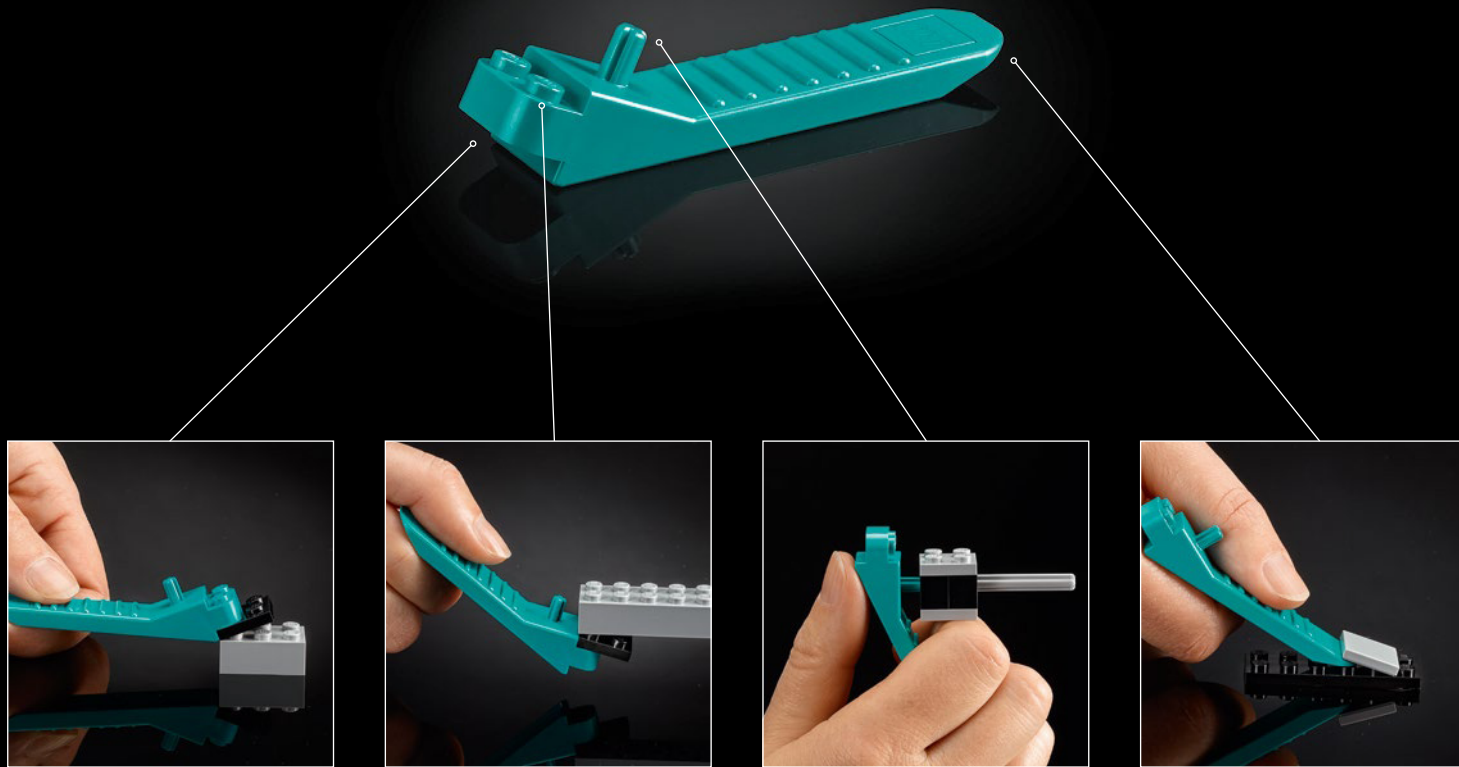

[LEGO.com/brickseparator](https://www.lego.com/brickseparator)

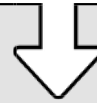
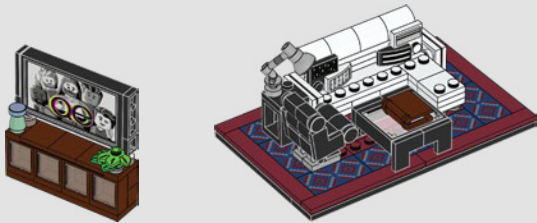
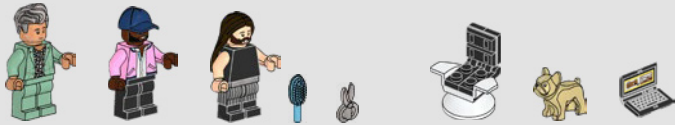
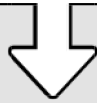

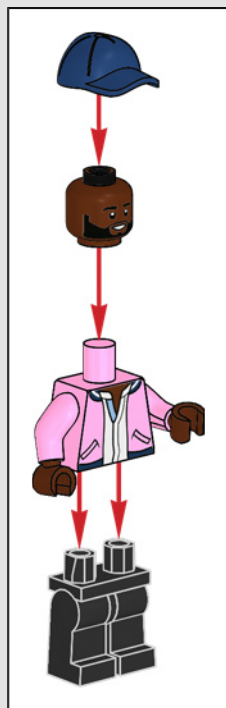
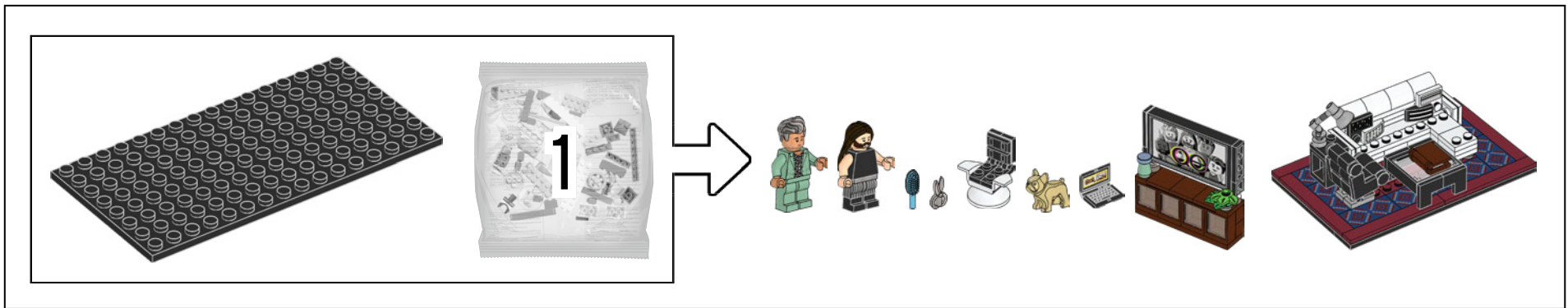

卡拉莫·布朗

“很高兴看到他们让我穿着一件标志性的卡拉莫短夹克，棒球帽也很有品位，可以遮盖我不太雅观的光头！哈！”

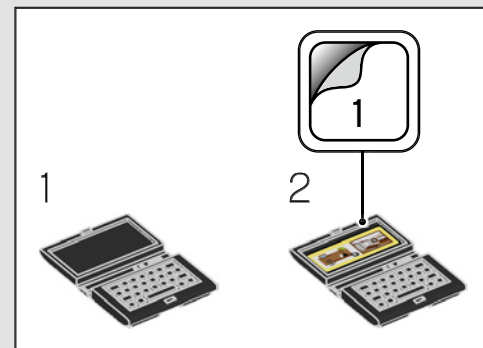
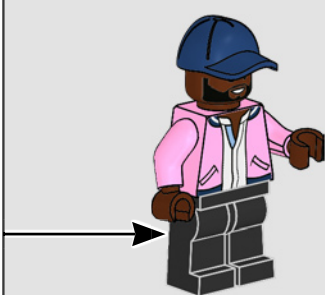

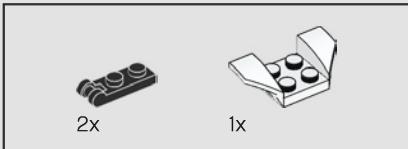

1

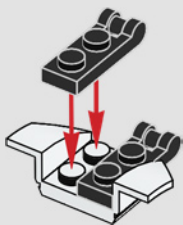

2

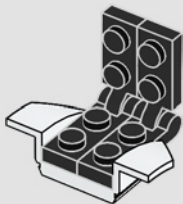

3

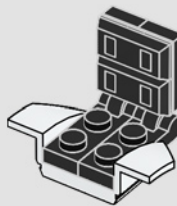

4

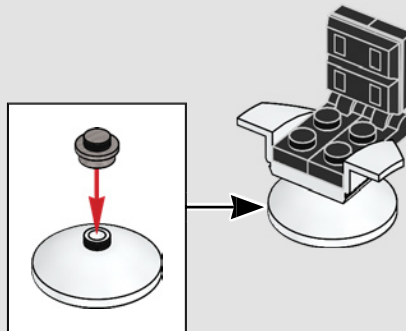

谭·法郎士

“哈！那顶小巧的乐高假发太完美了！非常像我的真头发，梳好头发，喷上发胶，发型就丝毫不变了。”



乔纳森·凡·奈斯

“乐高会令我们更可爱些吗？！”

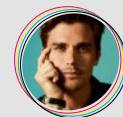

安东尼·波罗夫斯基

“他们还引入了 Bruley，太贴心了！我非常想念那条小狗！”

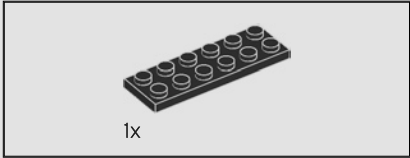
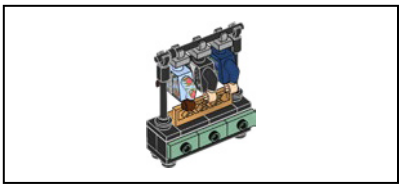

1

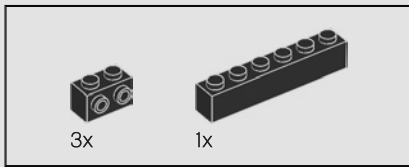
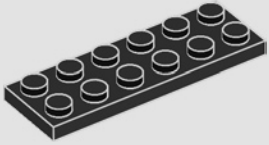

2

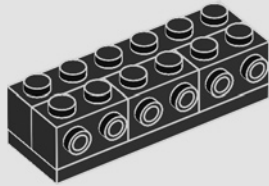

3

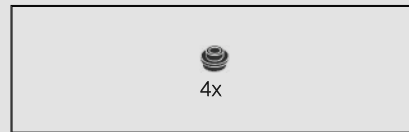
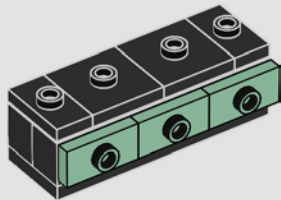

4

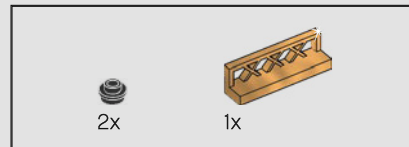
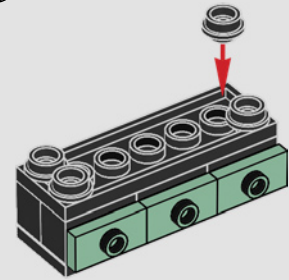
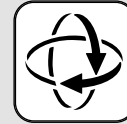

5

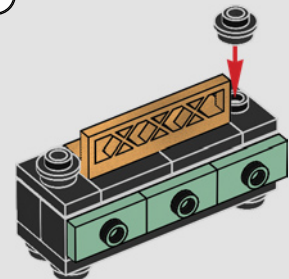
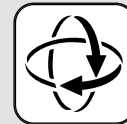



6

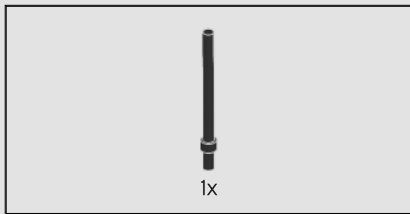
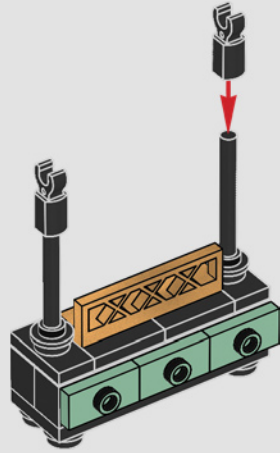

7

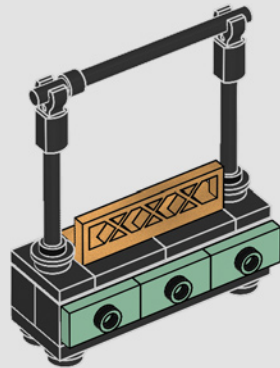

8

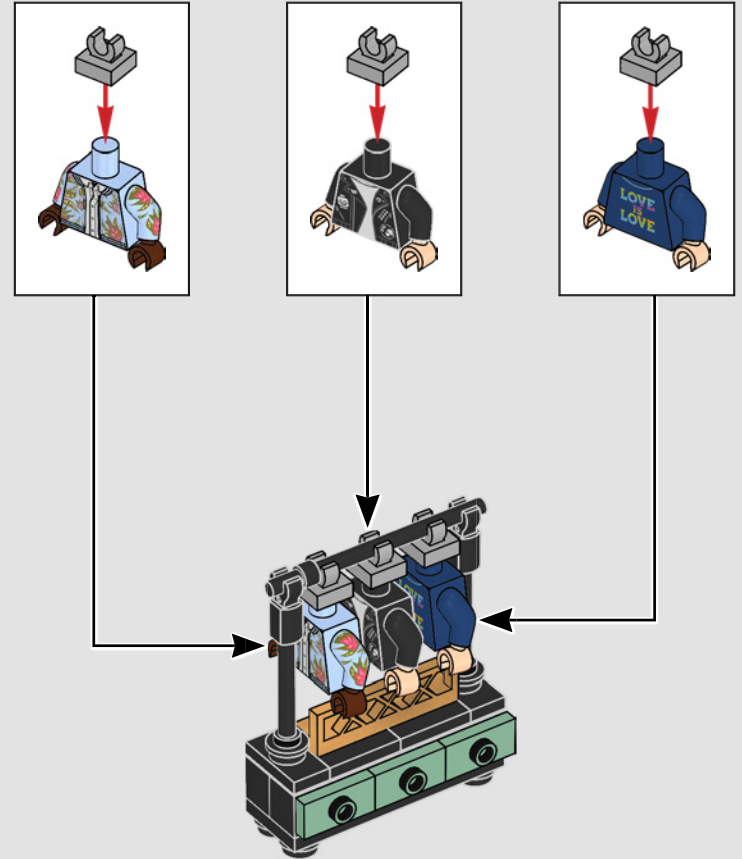

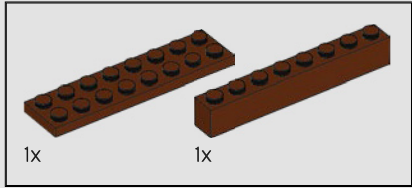

1

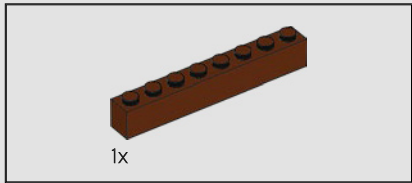
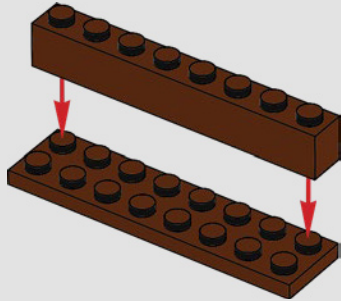

2

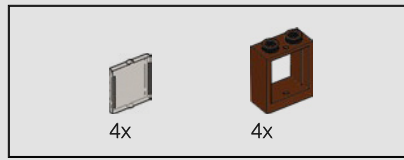
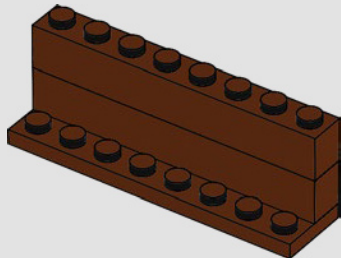

3

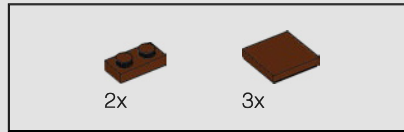
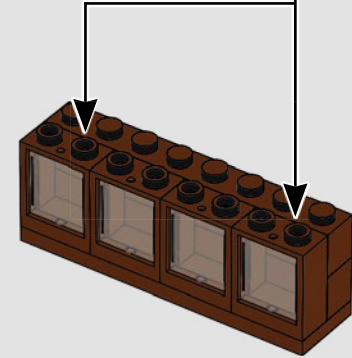
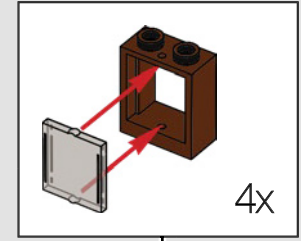

4

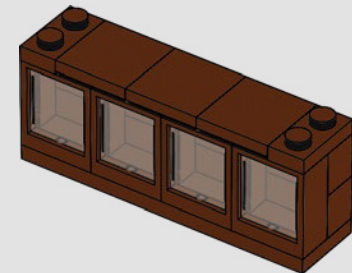



5

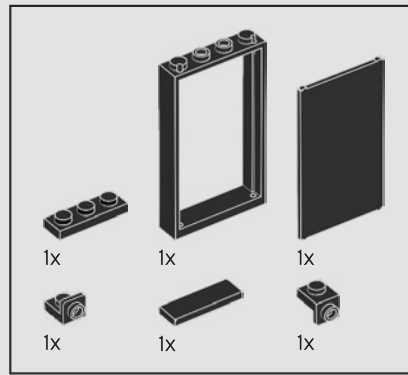
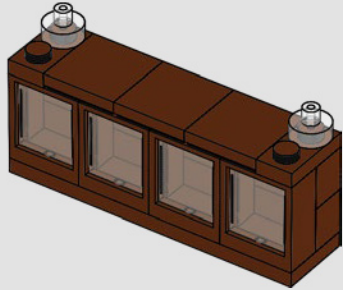

6

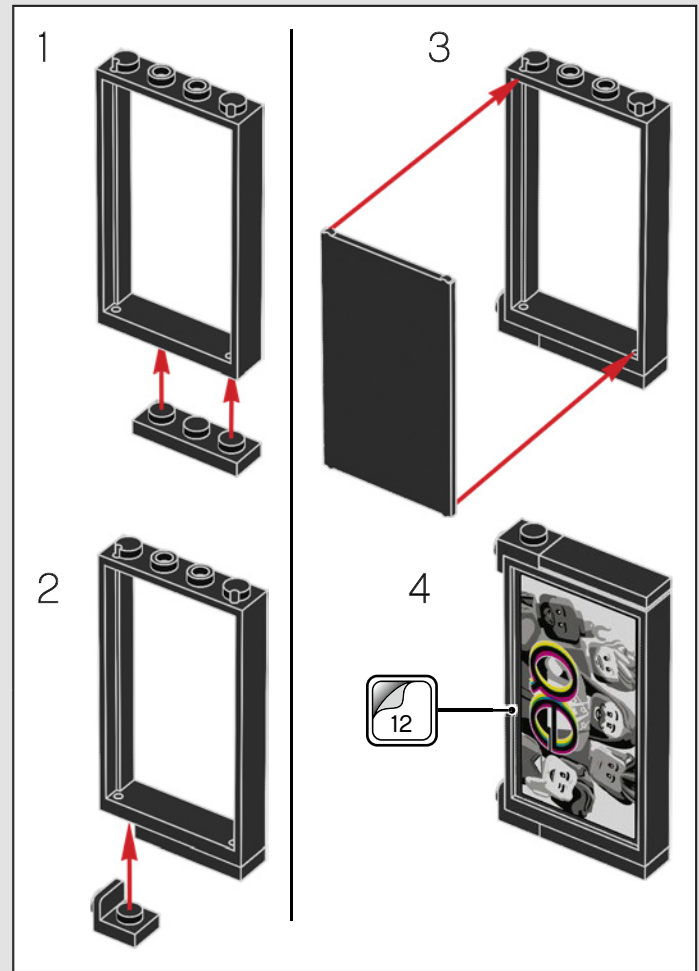
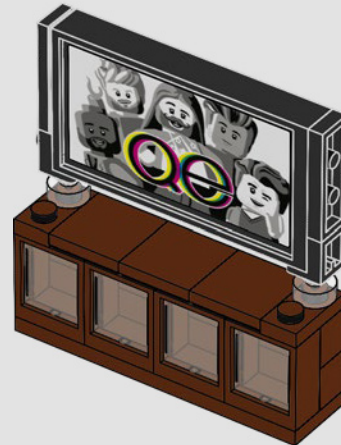

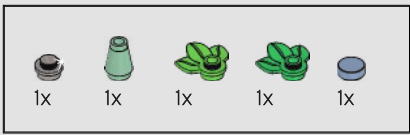

7



乔纳森·凡·奈斯

“人们能够把包容性融入他们的创造力非常重要。因此，对乐高公司来说，包容性地支持 LGBTQ 之类的主题是有必要的，而乐高确实做到了，我对此感到非常激动。”

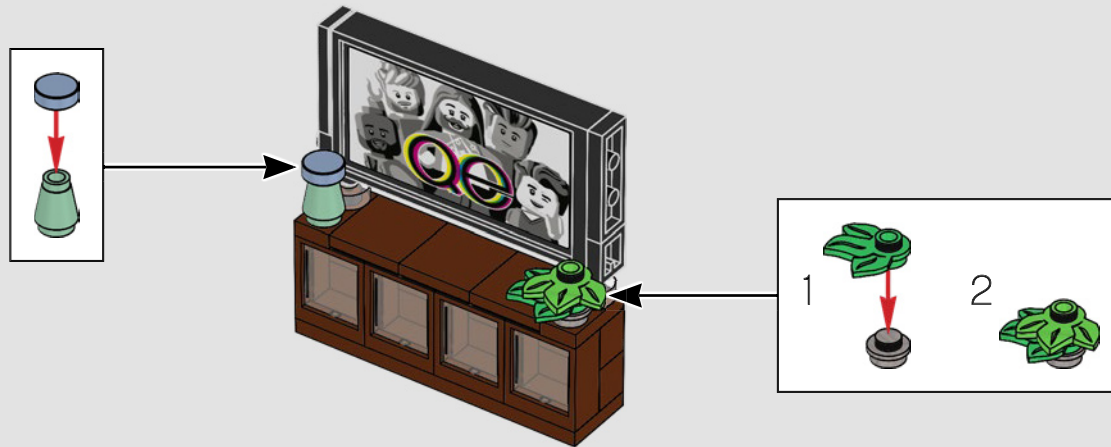

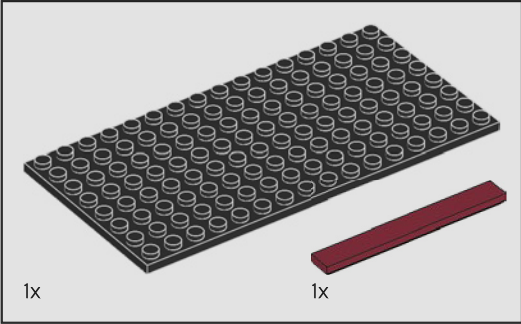
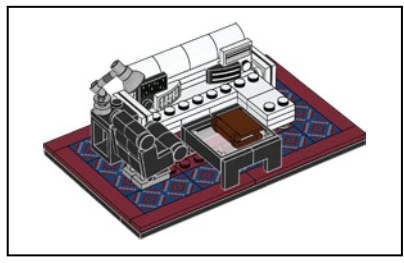

1

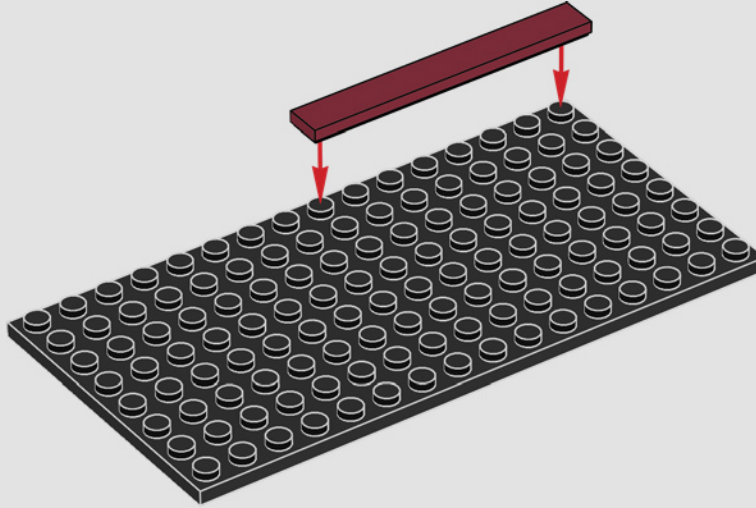

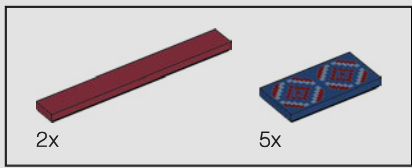

2

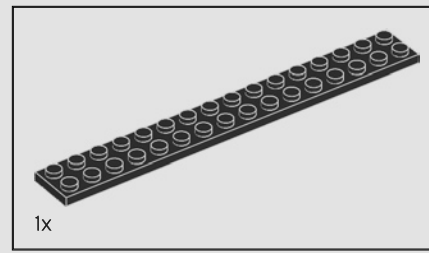
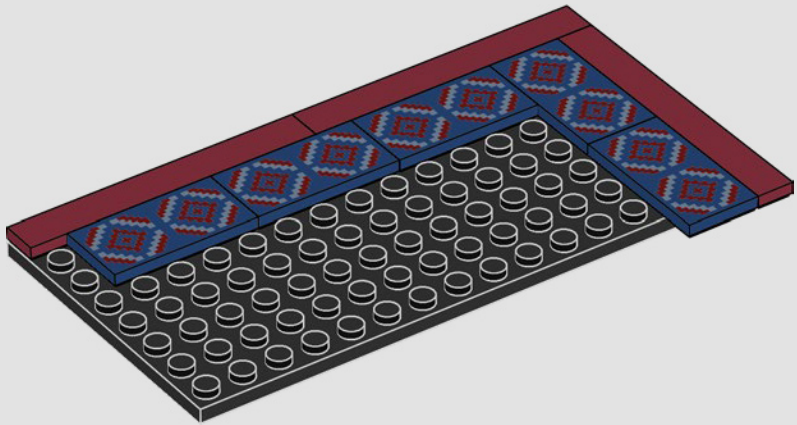

3

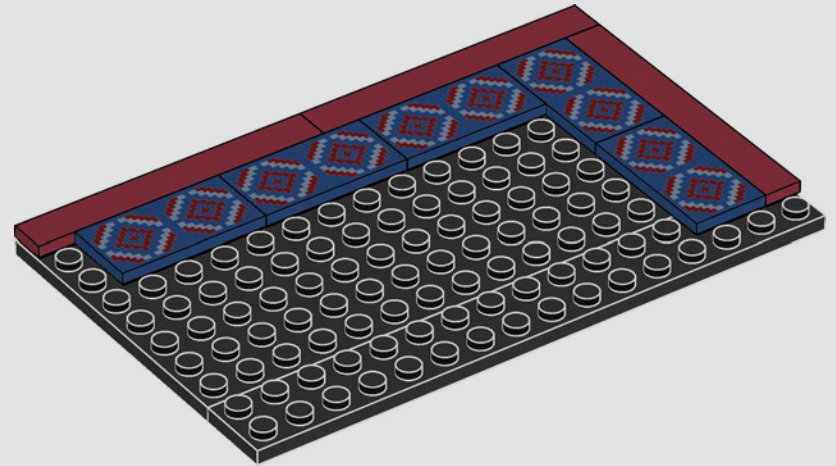

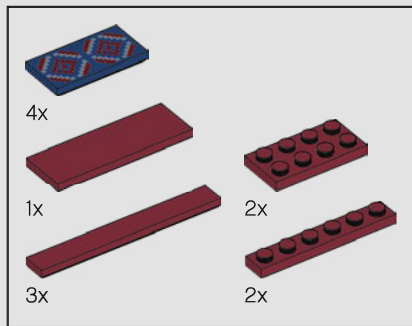

4

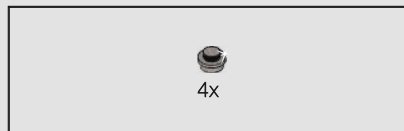
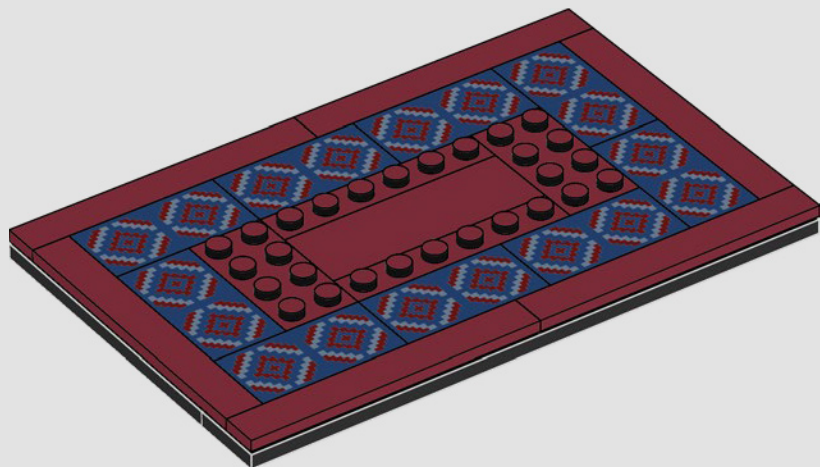

5

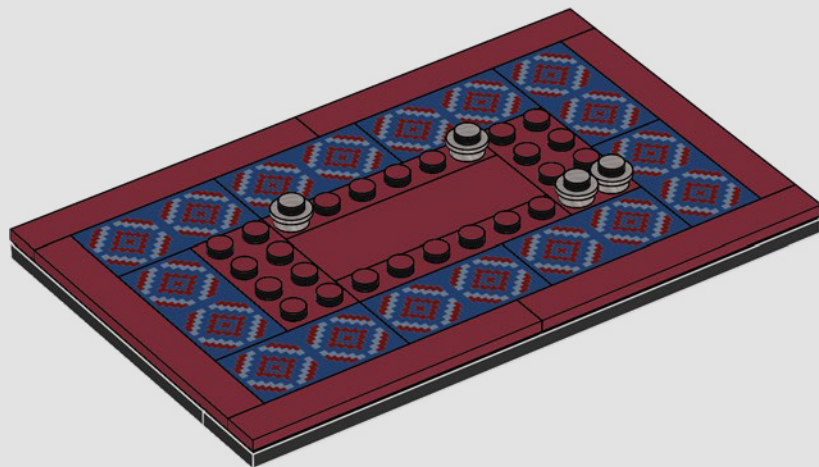

乔纳森·凡·奈斯

“能够成为模型的一部分来激发人们的想象力，帮助他们创造更美好的世界，非常有趣！我希望人们能够通过这种合作激发他们的想象力。”

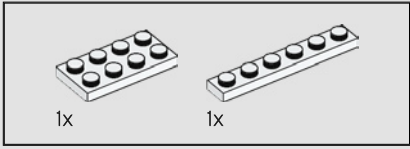
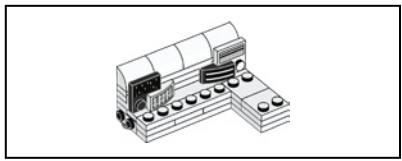

6

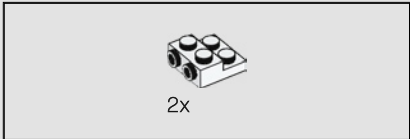
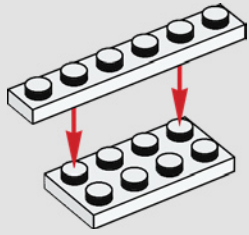

7

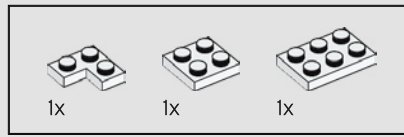
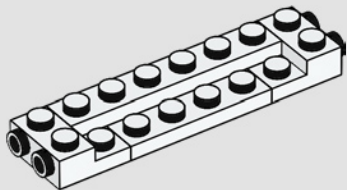

8

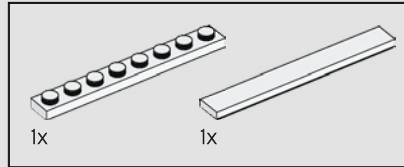
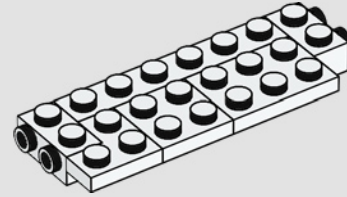

9

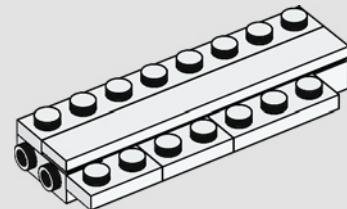

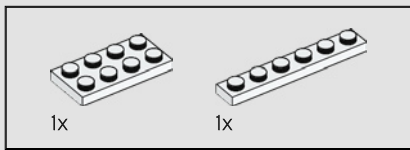

10

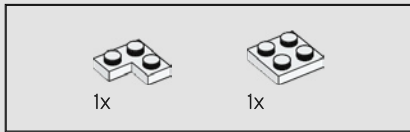
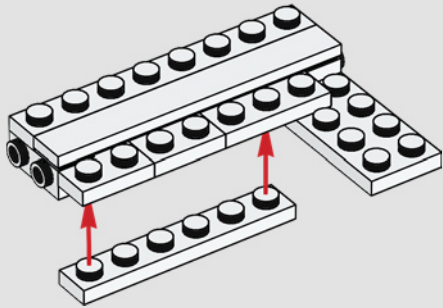

11

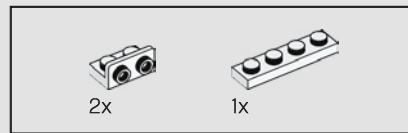
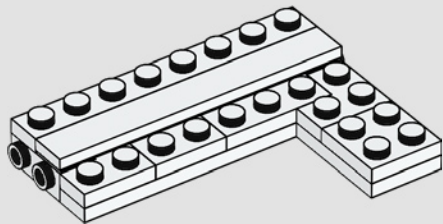

12

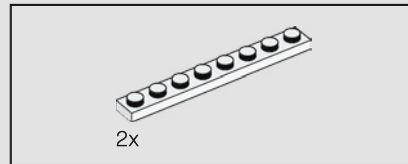
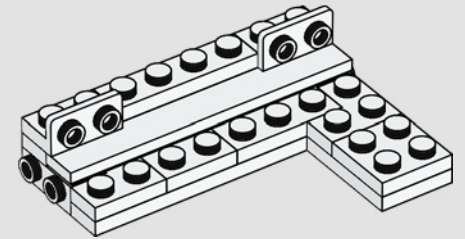

13

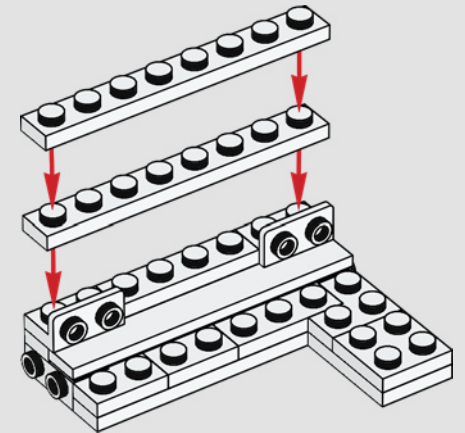

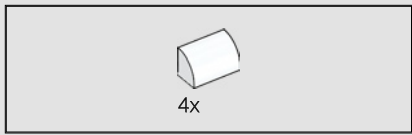

14

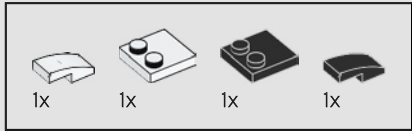
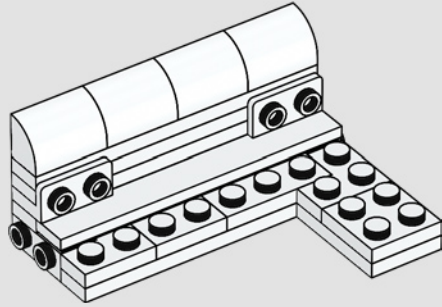

15

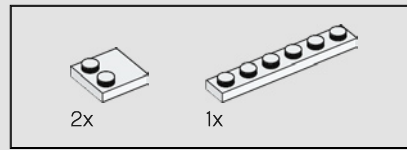
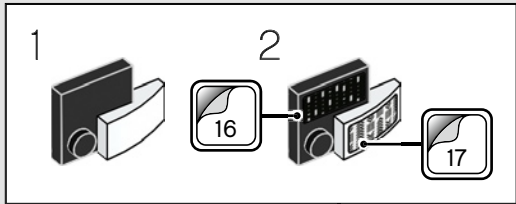
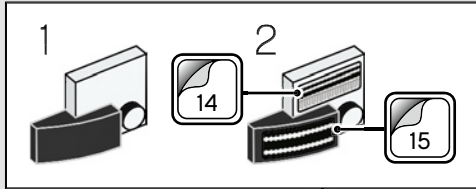

16

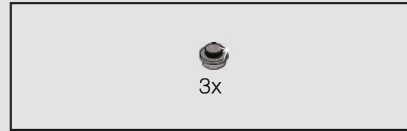
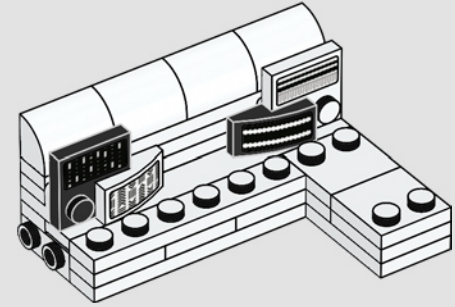

17

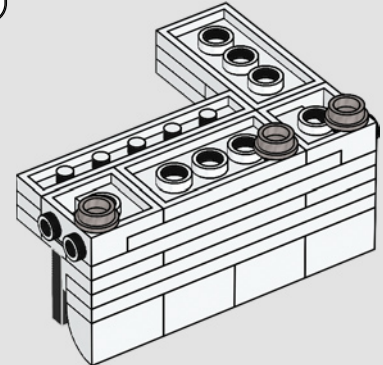
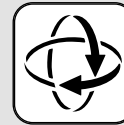

18

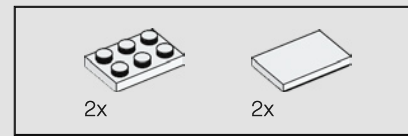
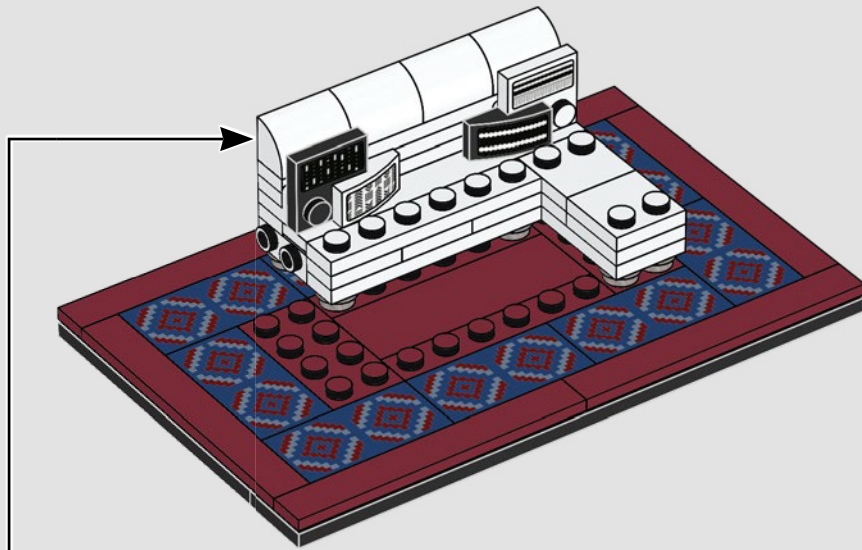

19

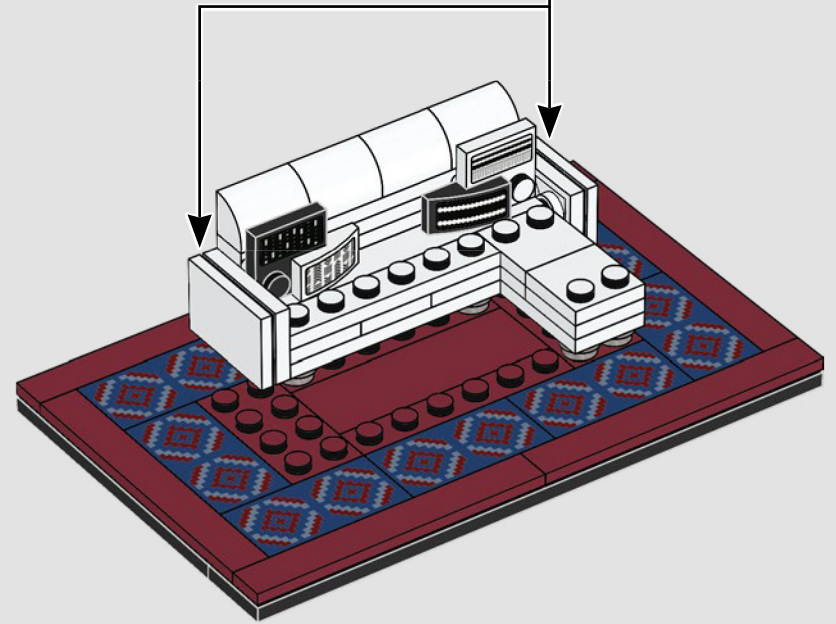
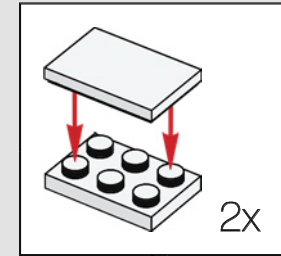

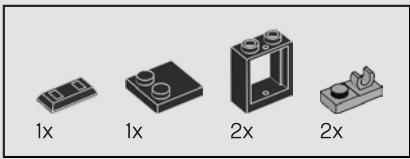

20

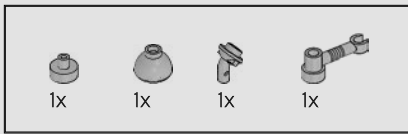
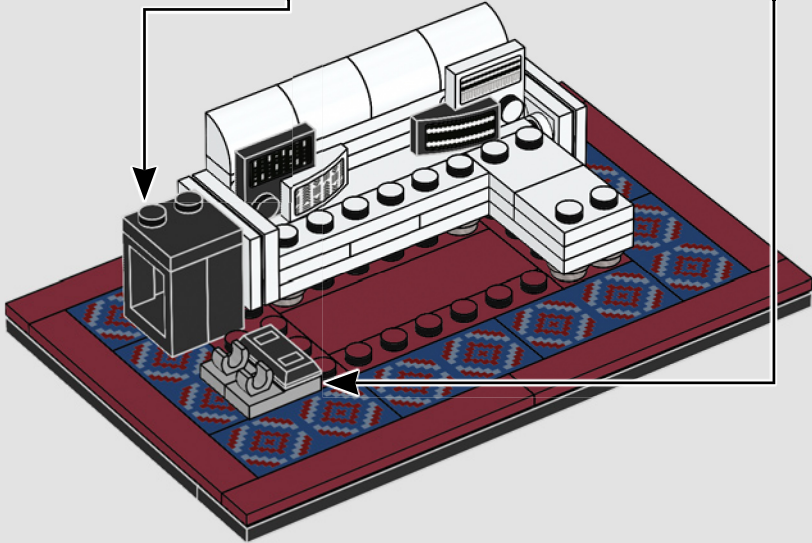
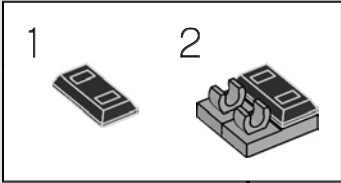
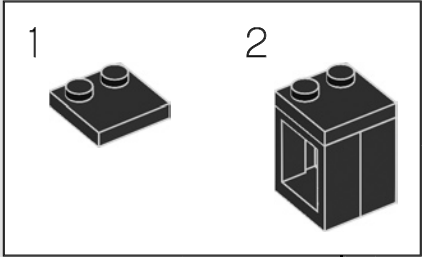

21

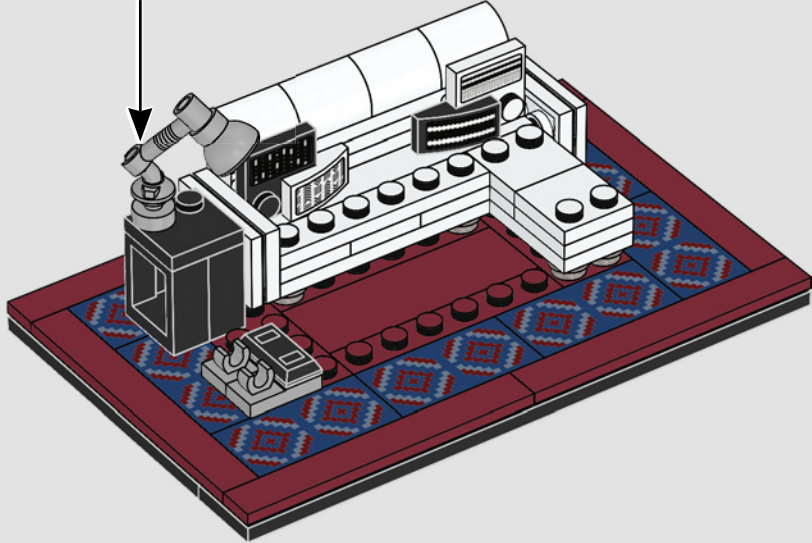
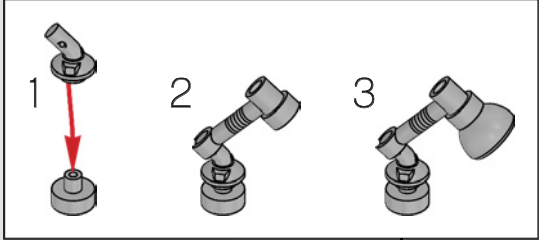

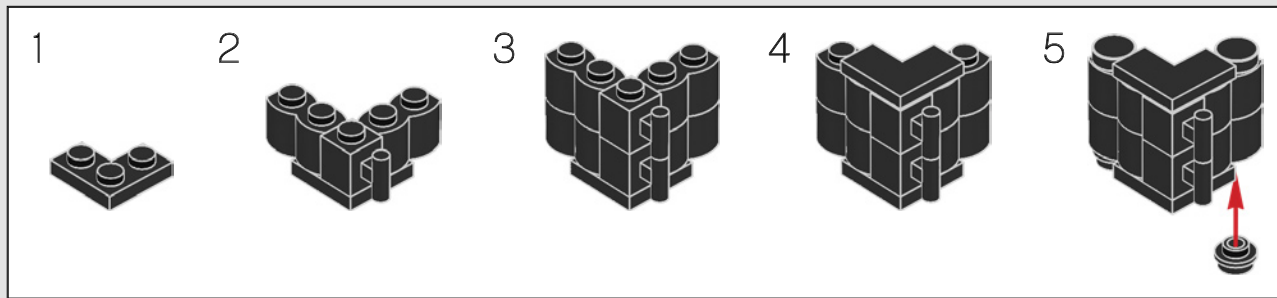
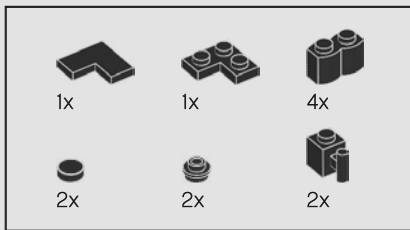

22

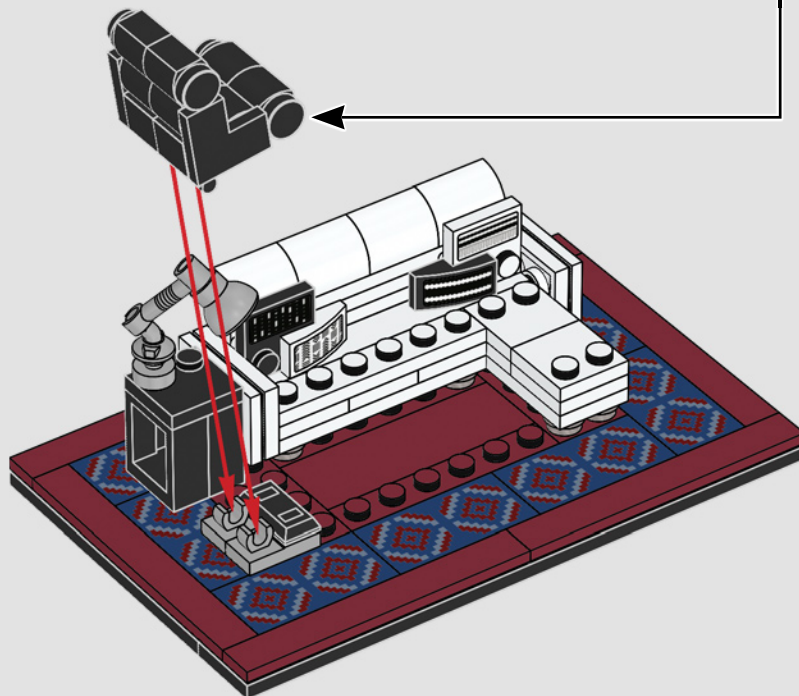

谭·法郎士

“我非常喜欢创造过程，而乐高®非常适合这种创造力，你可以自己独特的方式拼搭任何想要的事物。”

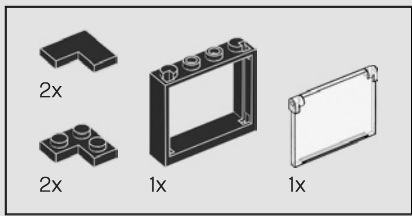

23

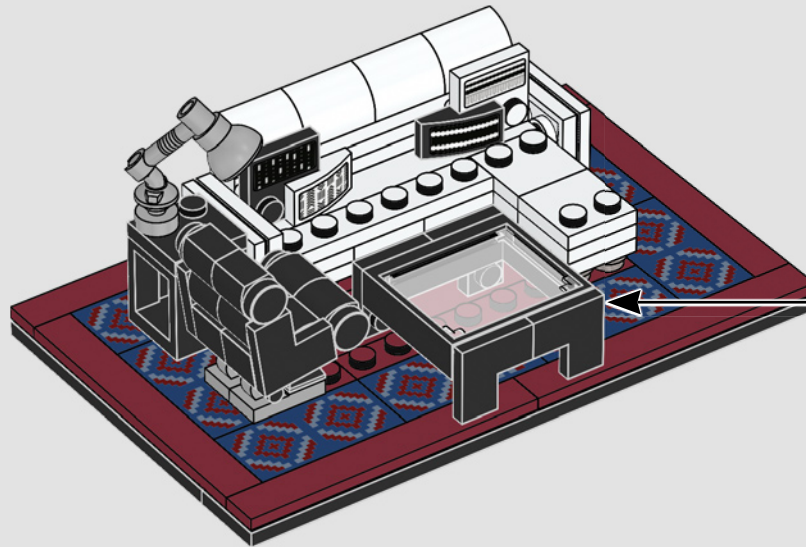
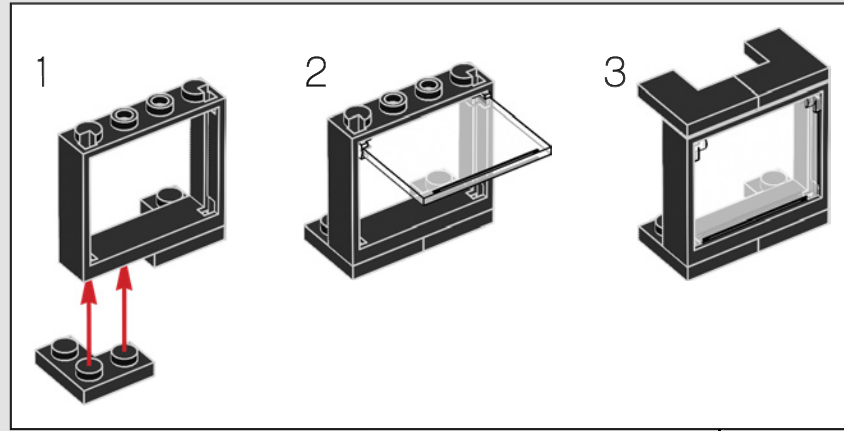

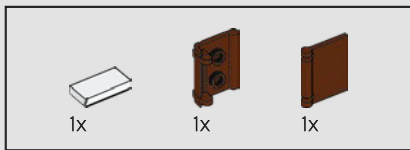

24



卡拉莫·布朗

“睹物思情，这款套装给我带回了许多美好的回忆。就像我收缩下来，来到演播现场，重温整个节目！”

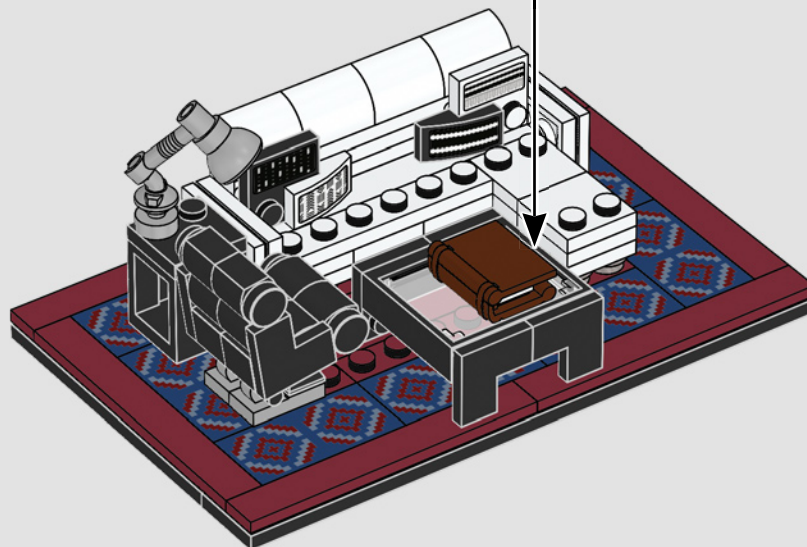
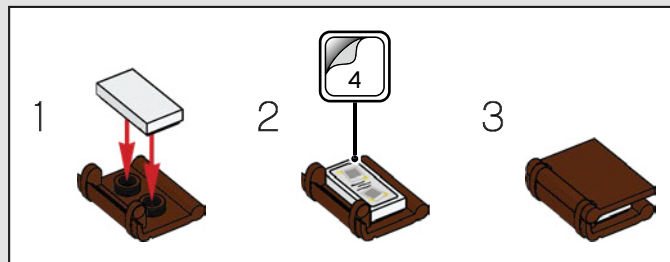

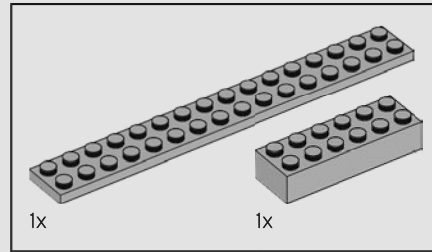
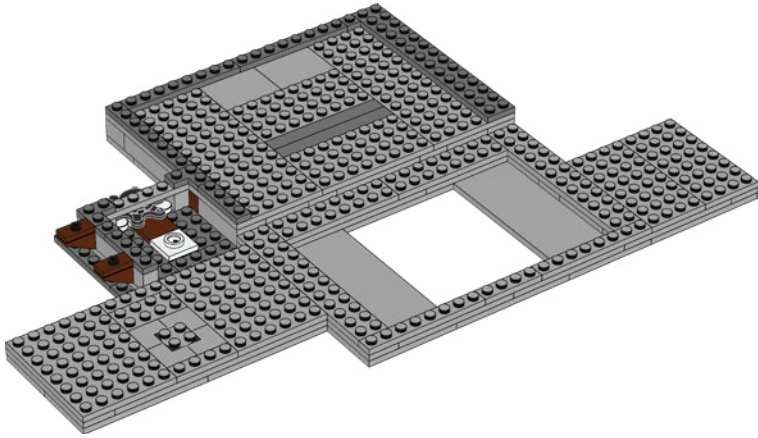
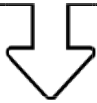

1

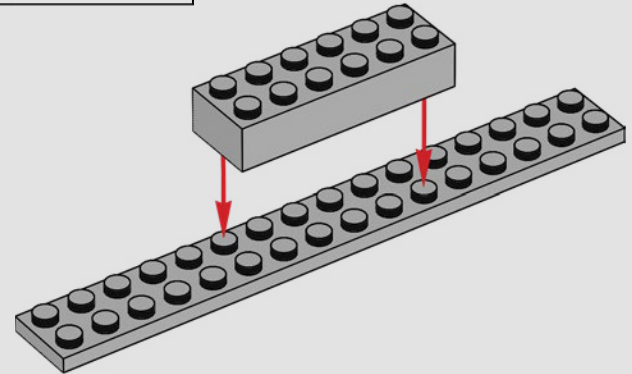

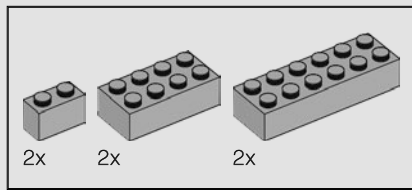

2

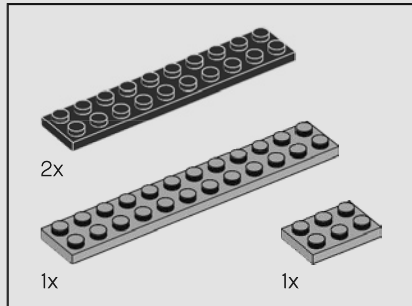
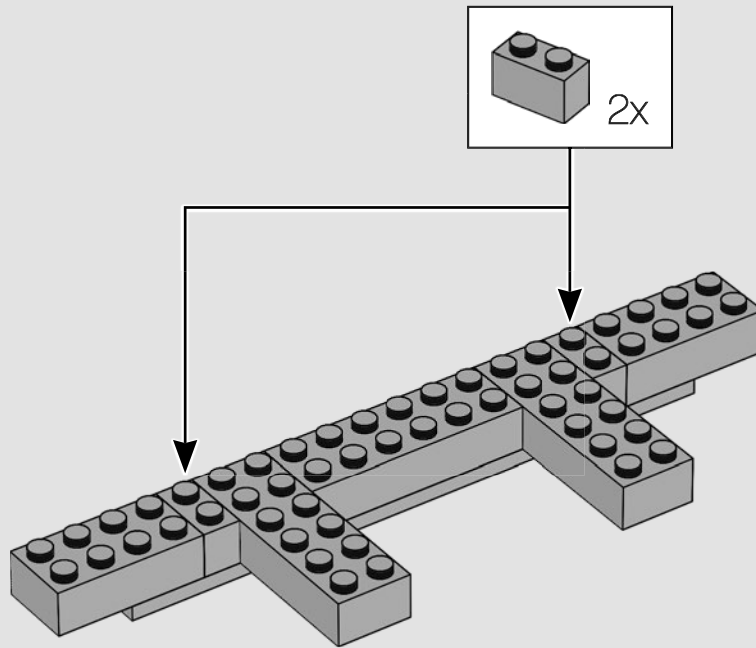

3

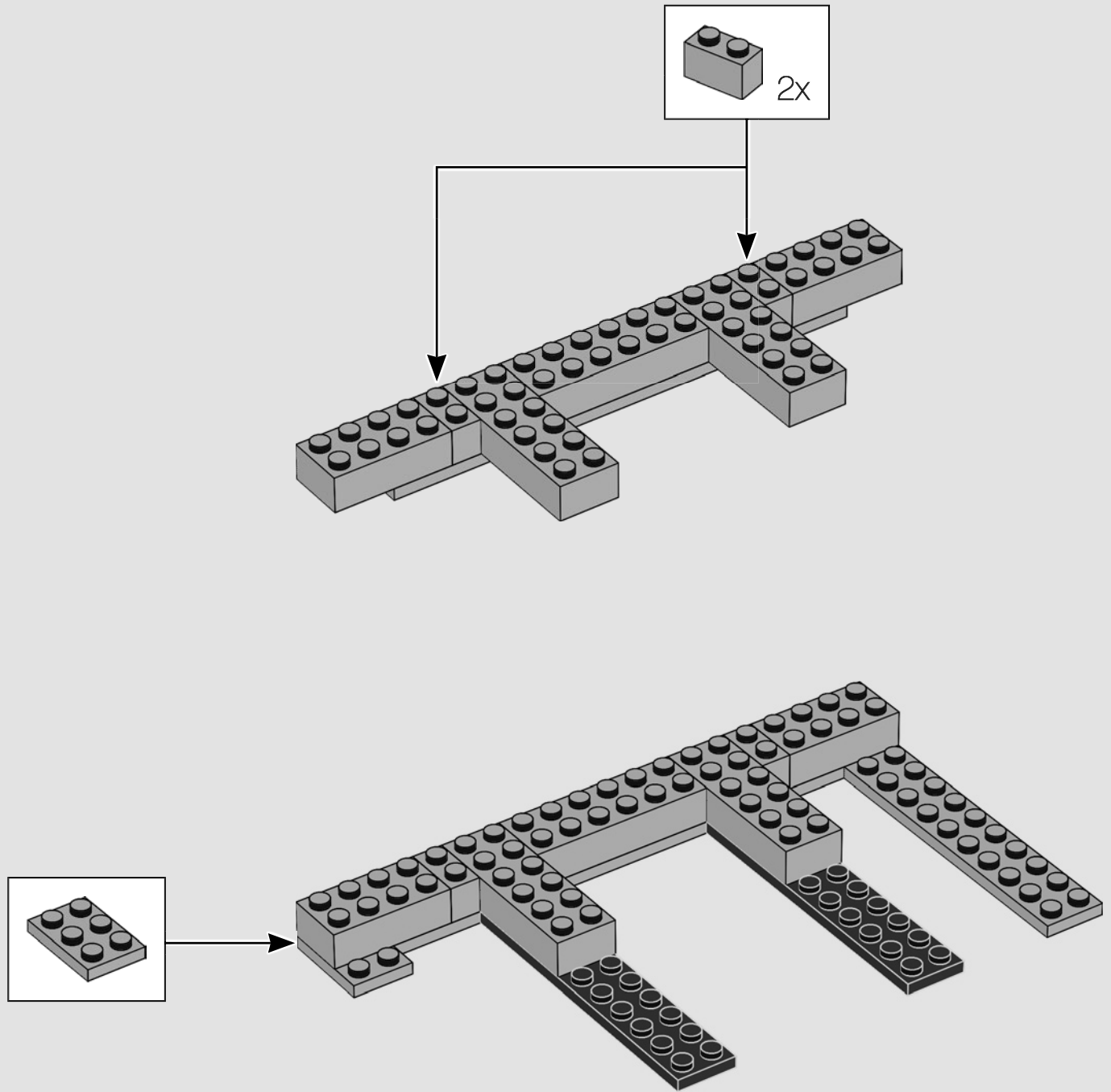

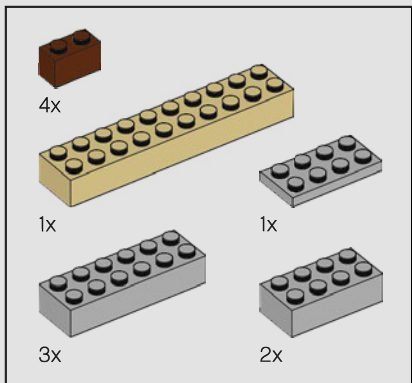

4

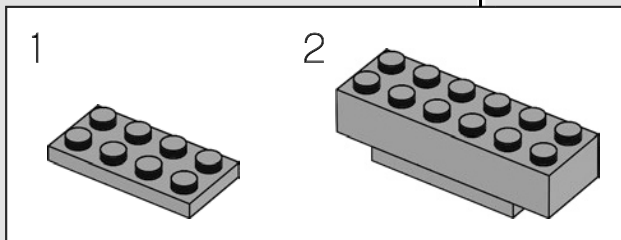
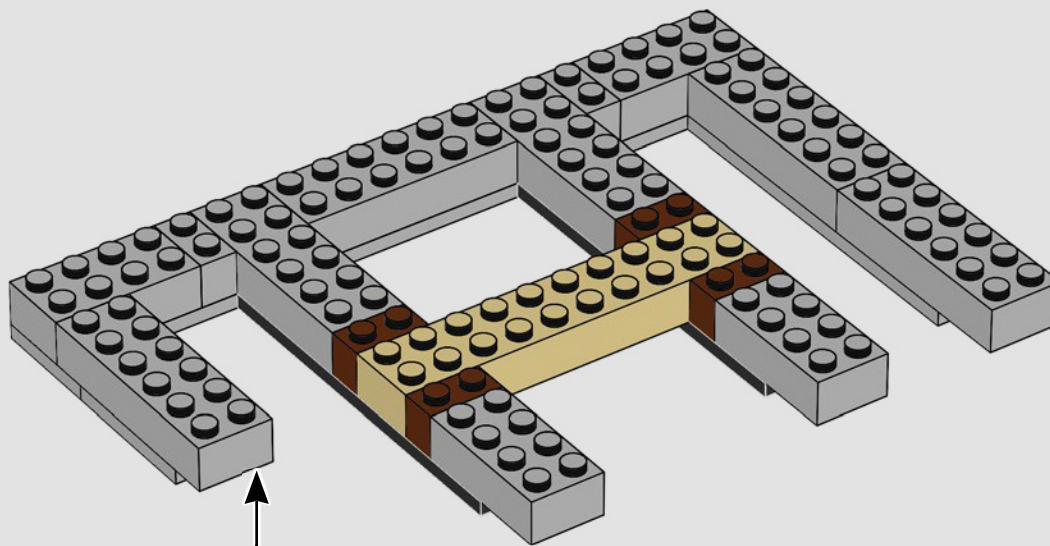

卡拉莫·布朗

“《粉雄救兵》这个节目非常特别，这得益于周围的人们，每天与我合作的出色演员，以及我在节目中触及和向世界分享的美妙生活。”

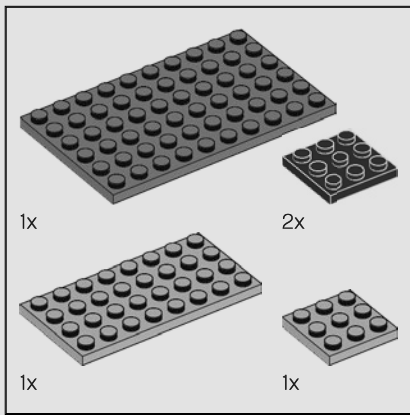

5

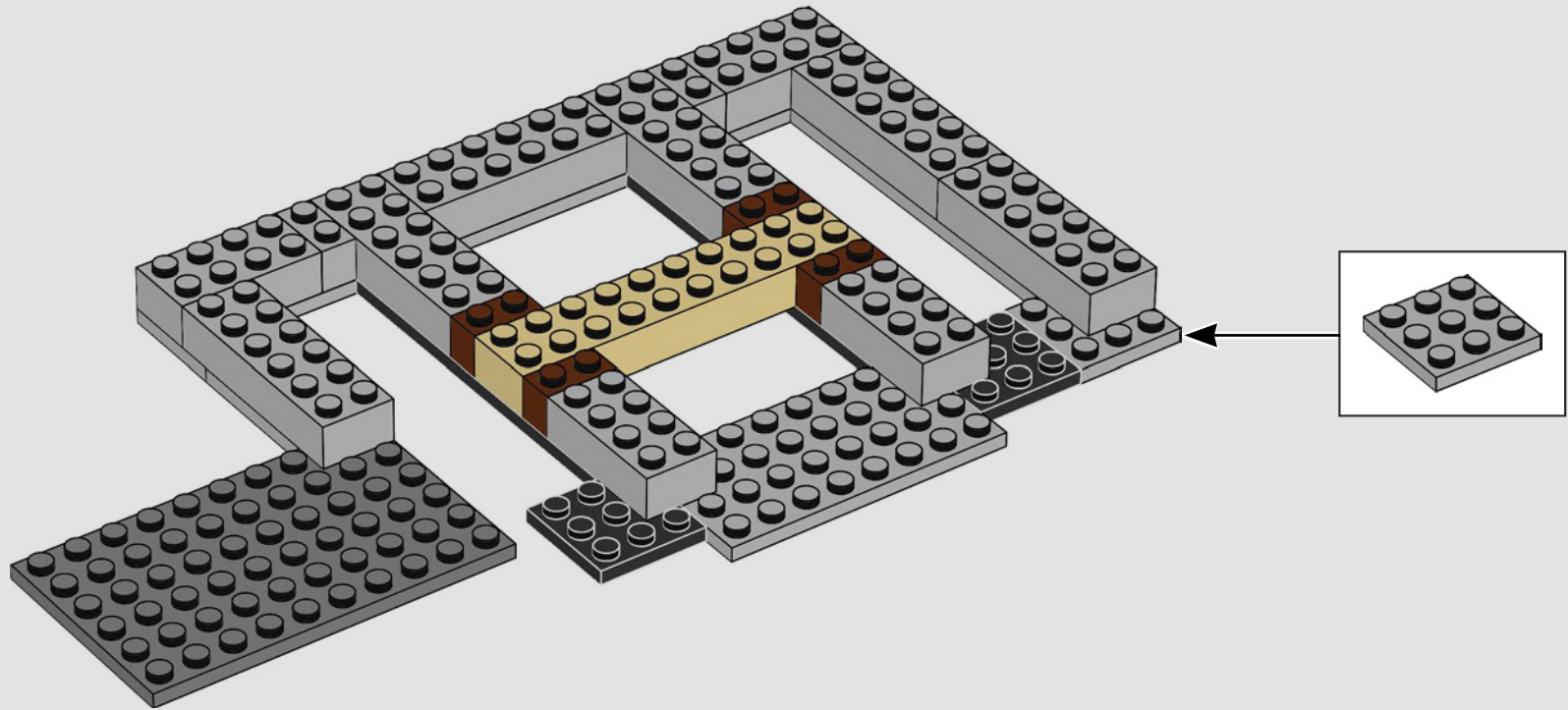

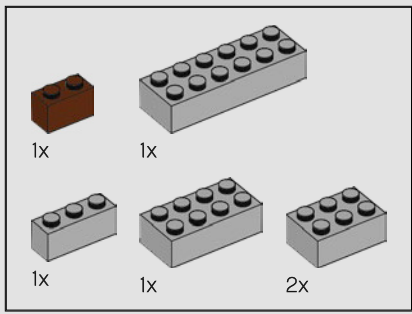

6

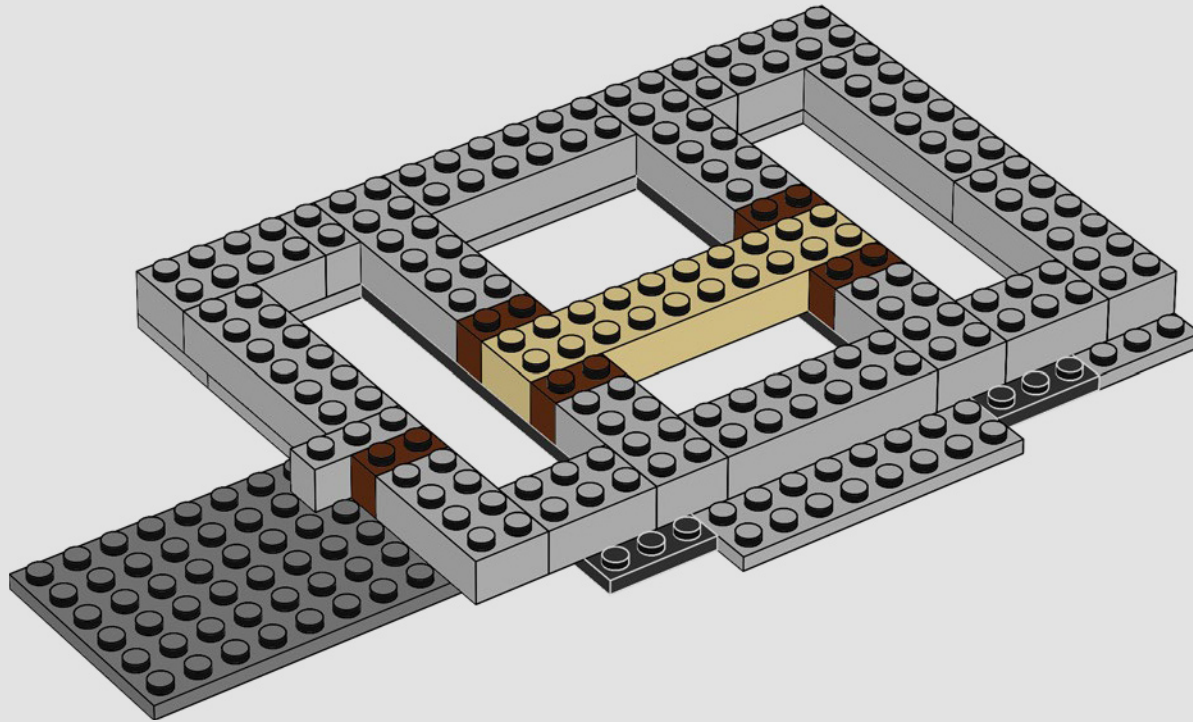

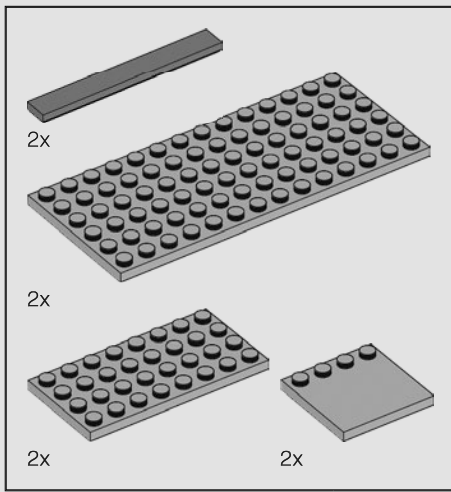

7

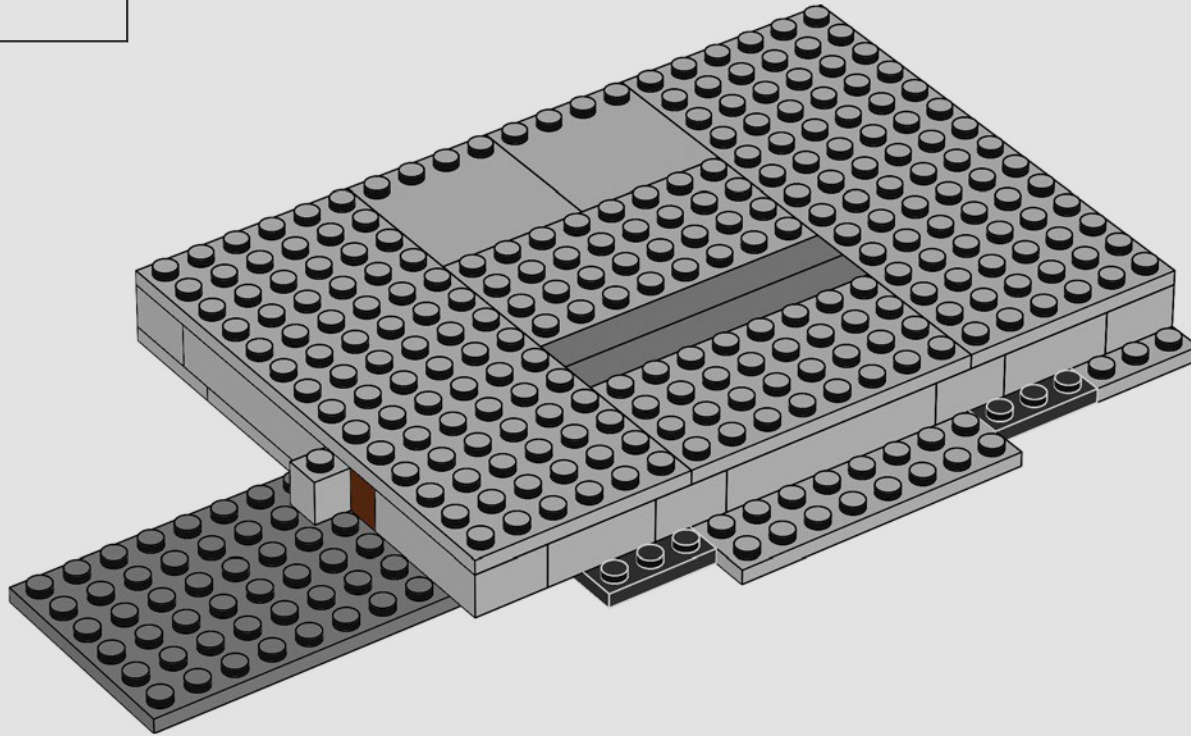

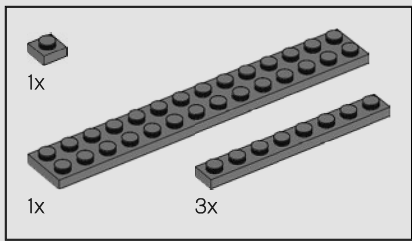

8

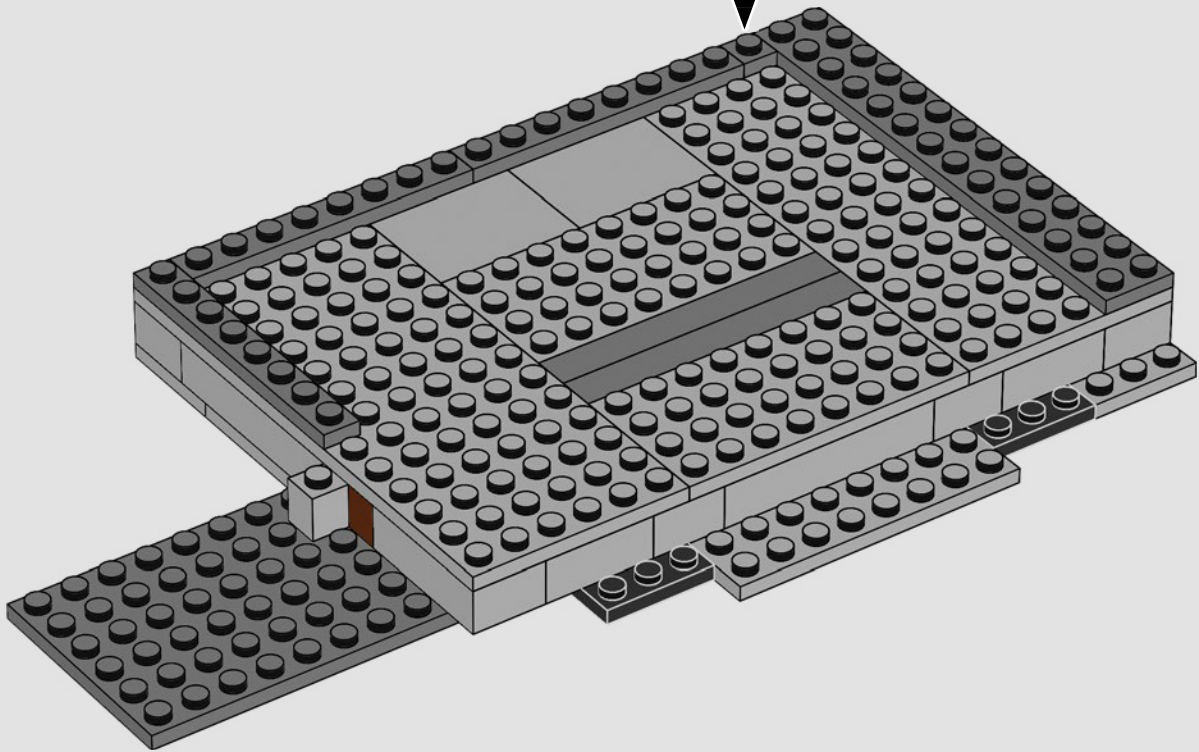
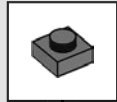

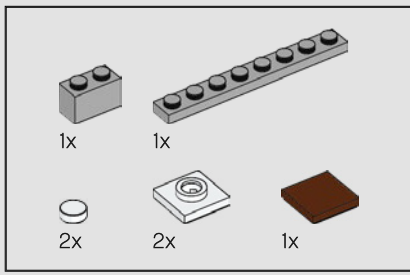

9

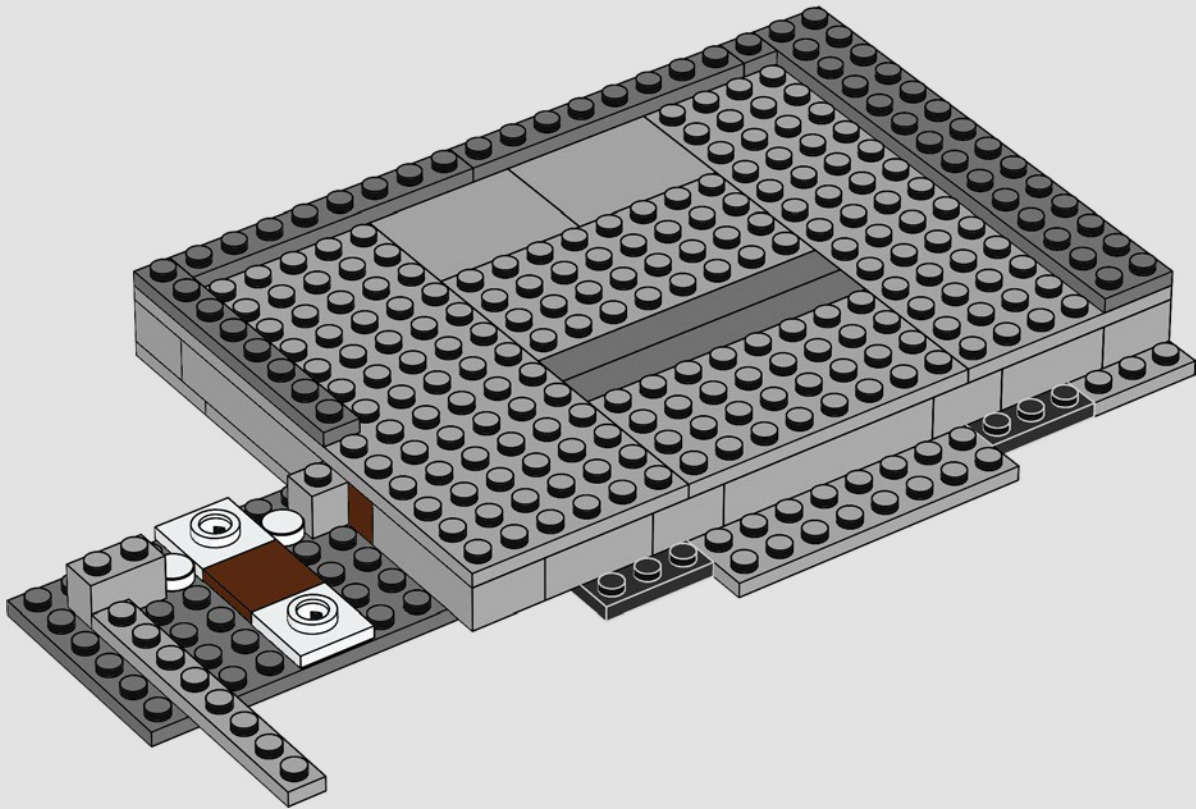

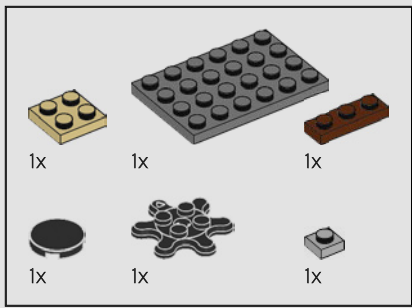

10

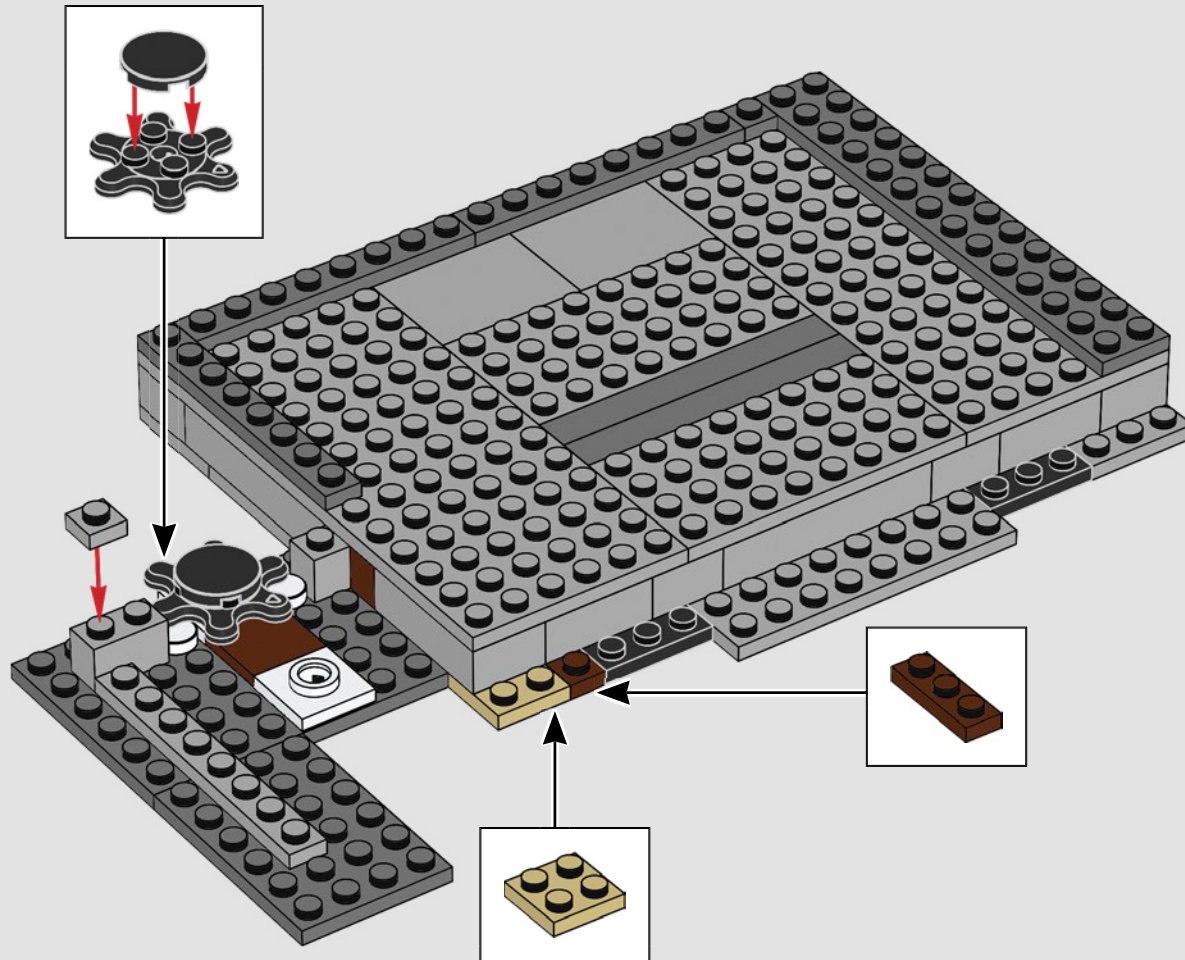

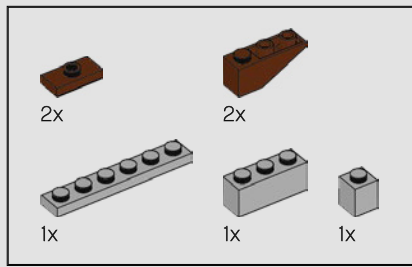

11

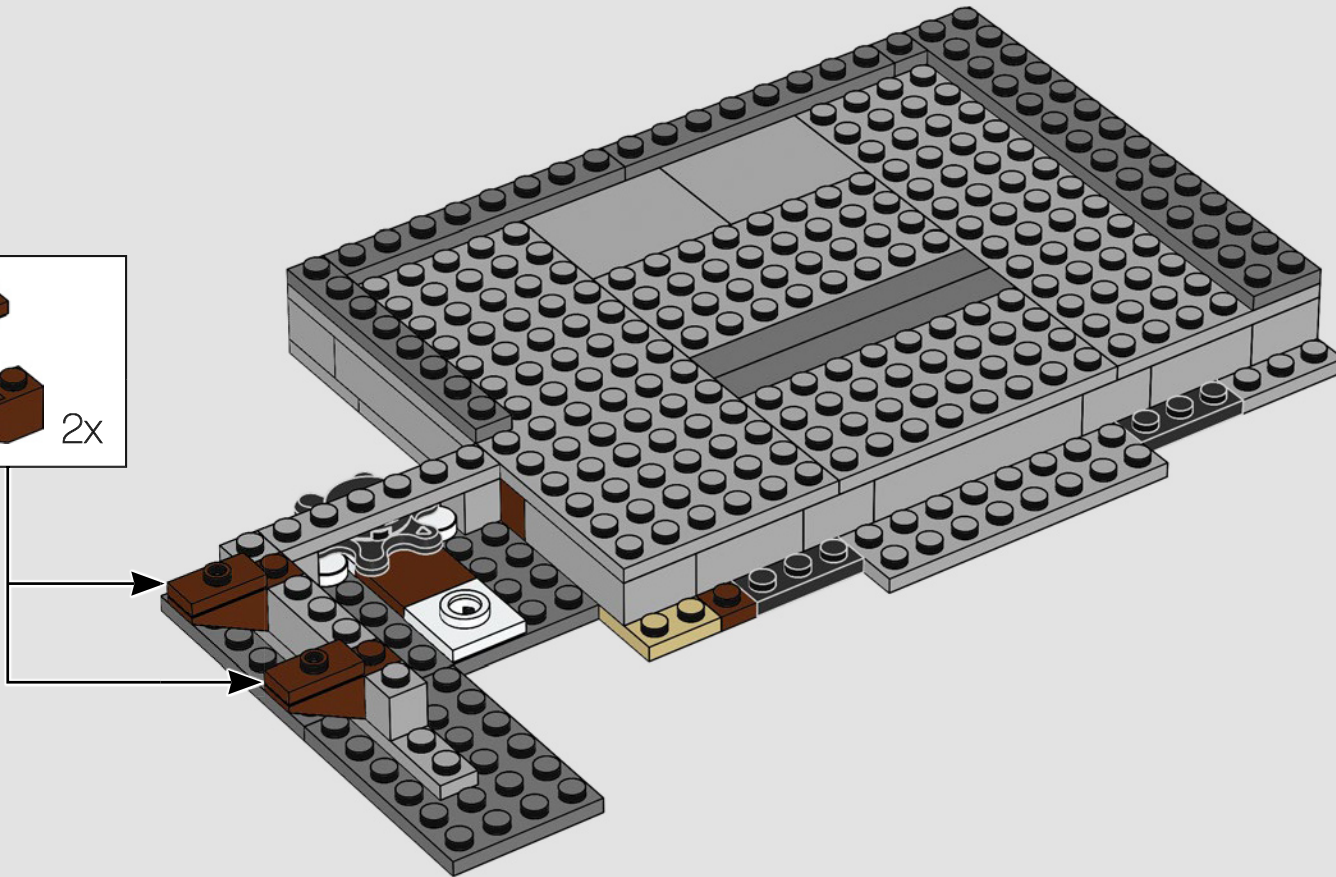
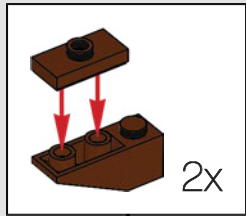

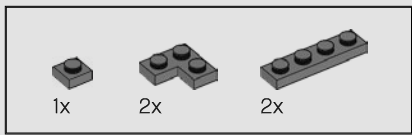

12

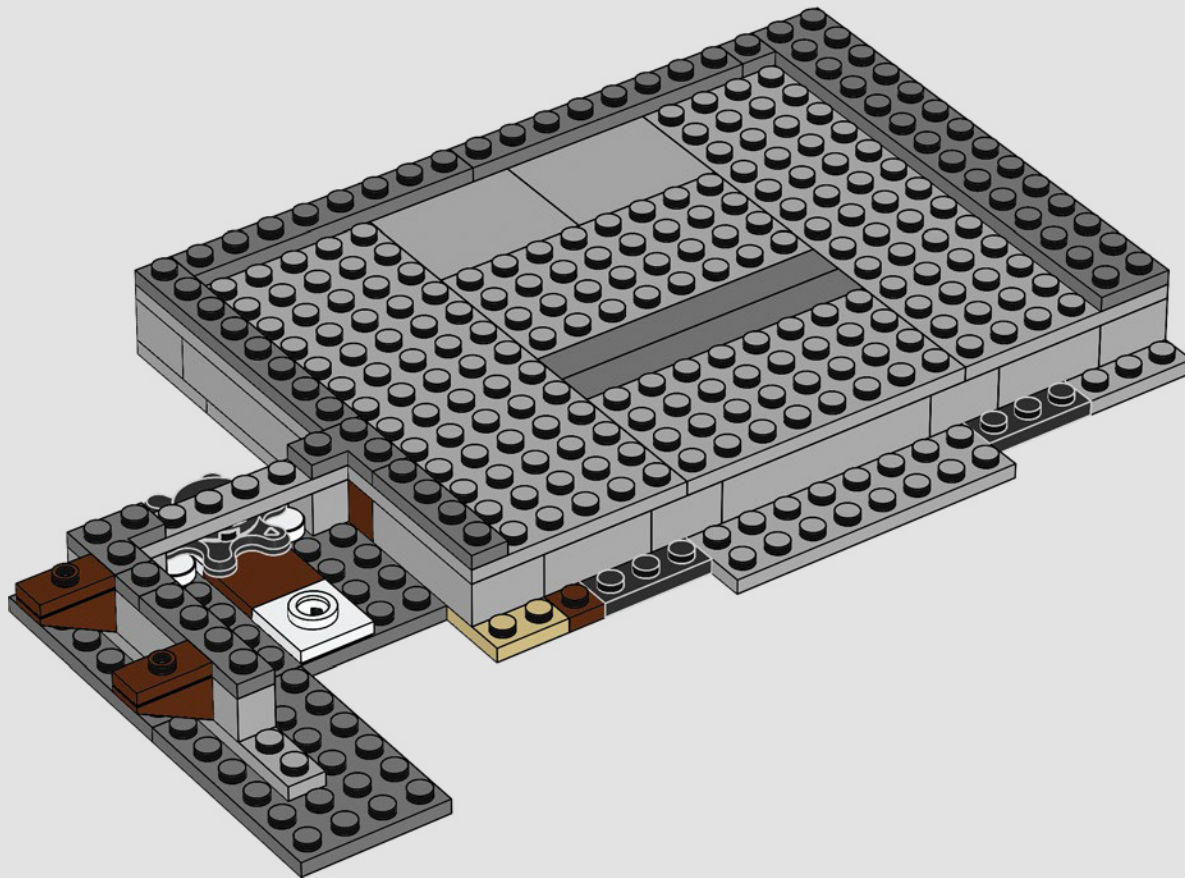

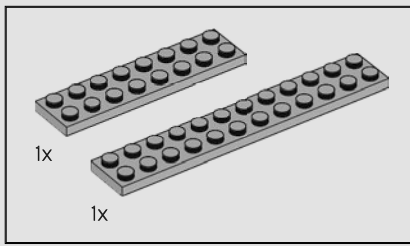

13

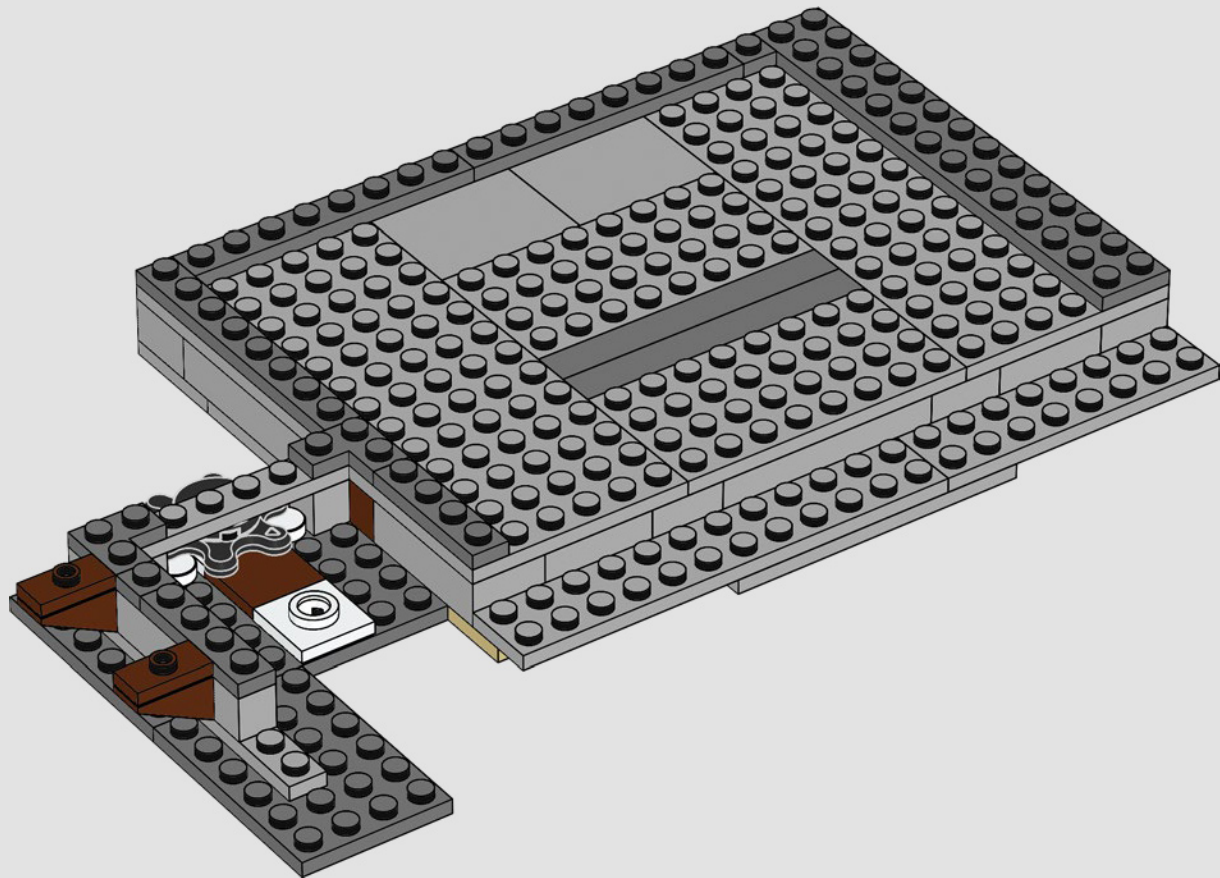

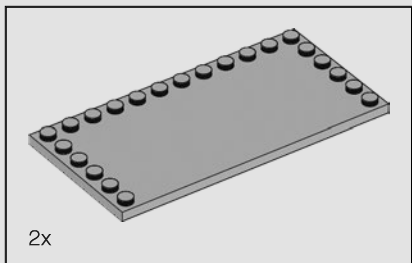

14

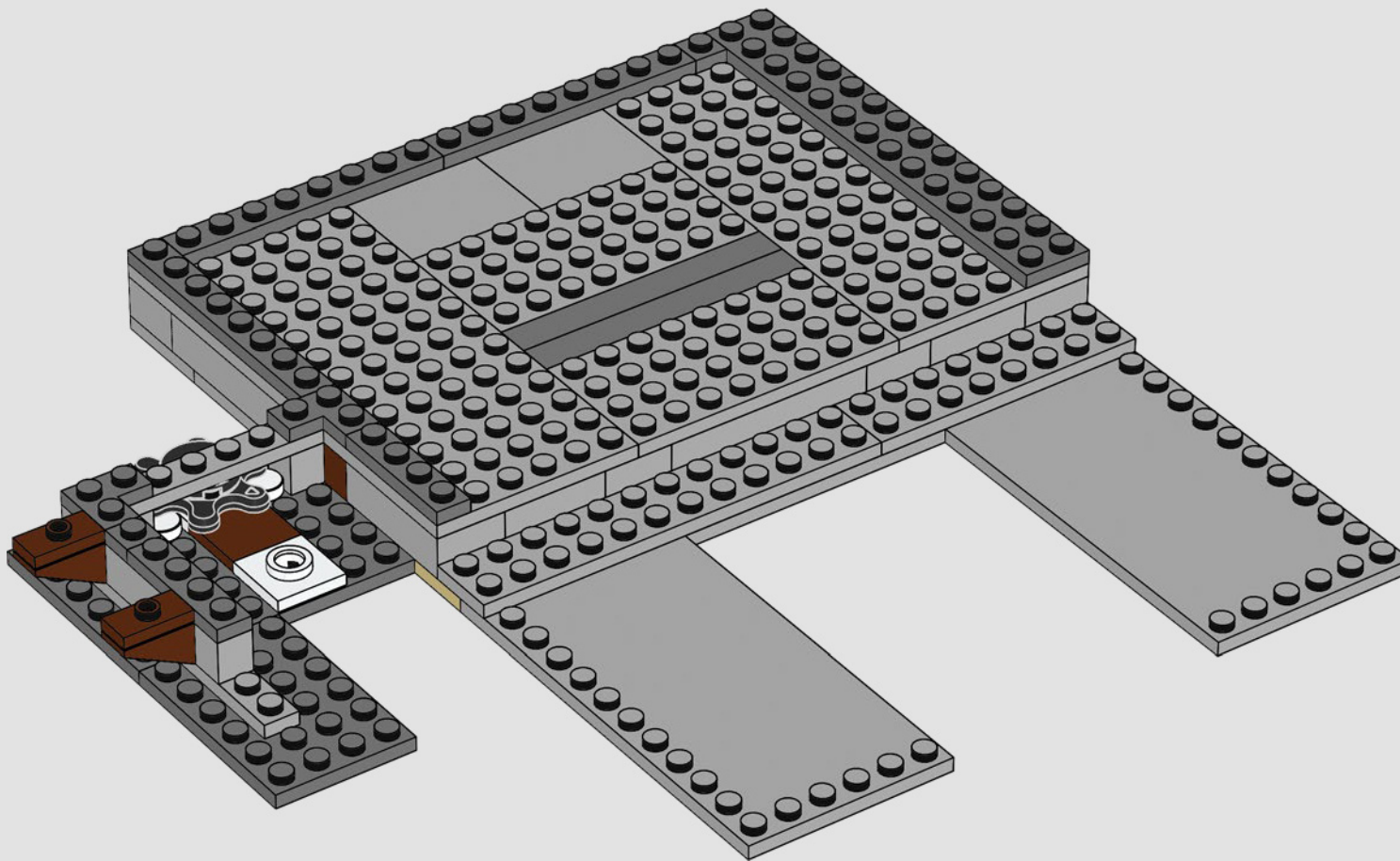

乔纳森·凡·奈斯

“我在《粉雄救兵》上的目标是建立一种联系，赢得一份理解，不仅同周围的人，还要理解和接受我们自己。”

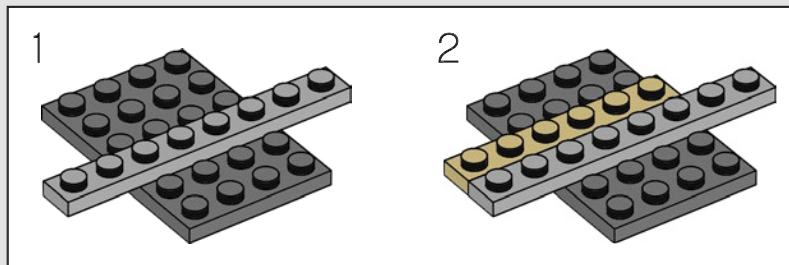
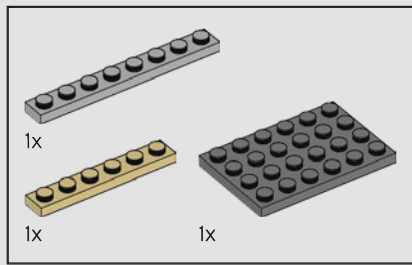

15

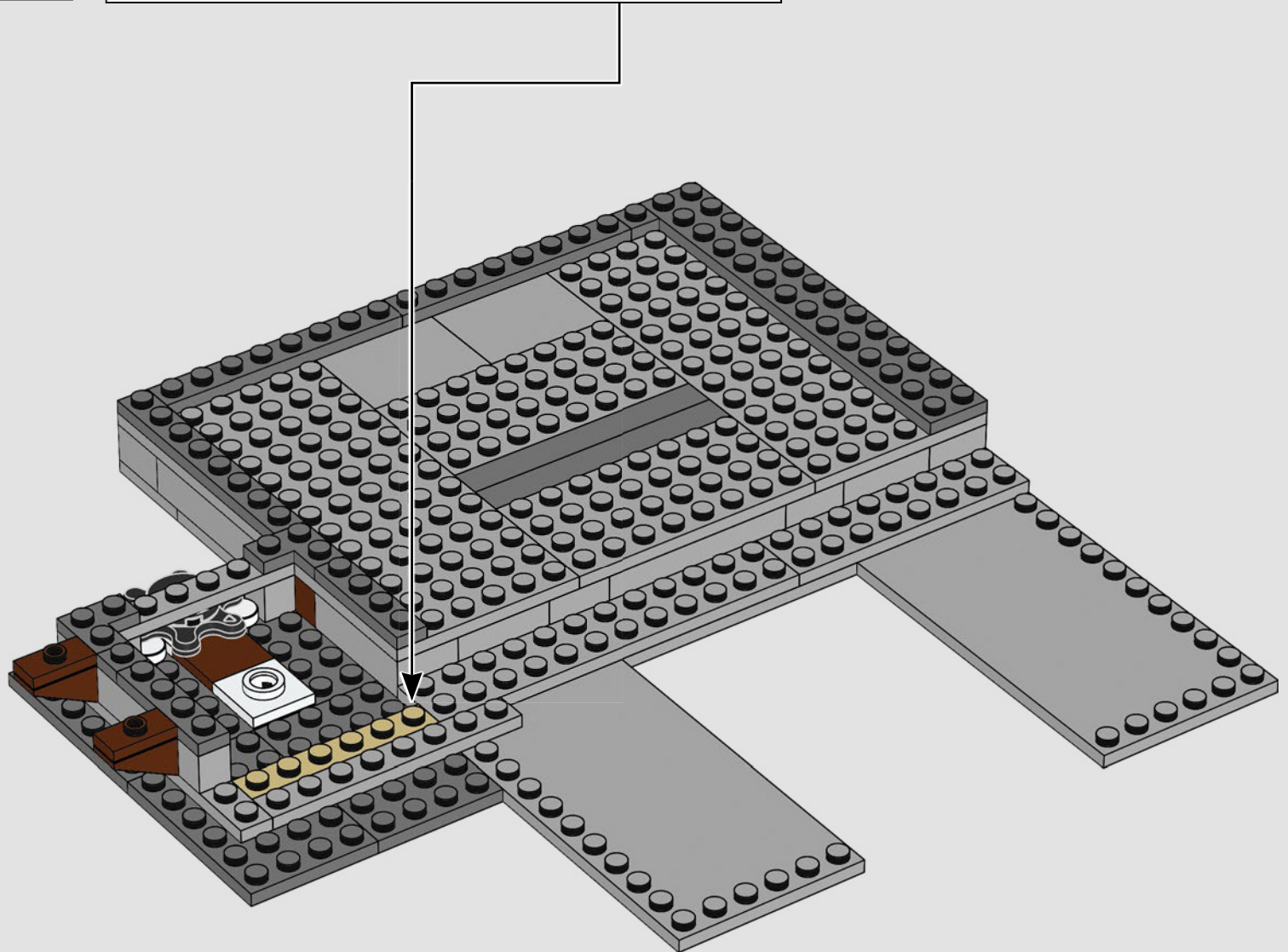

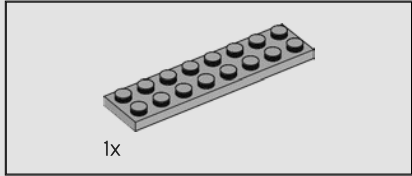
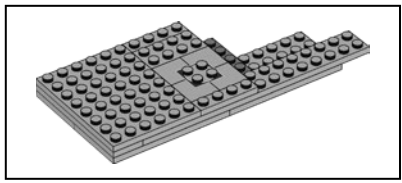

16

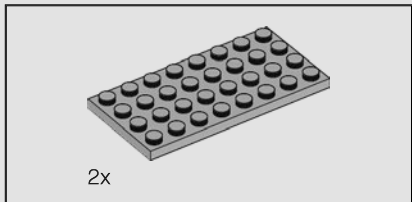
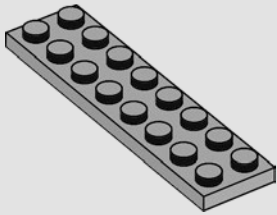

17

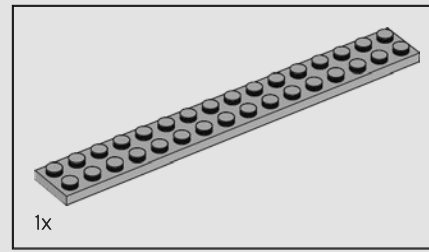
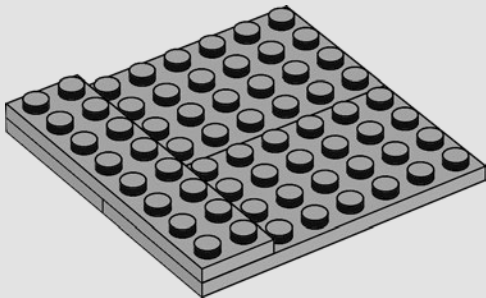

18

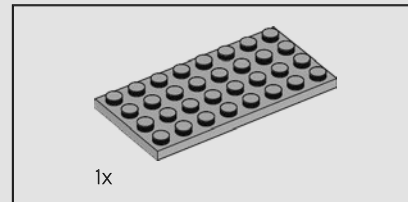
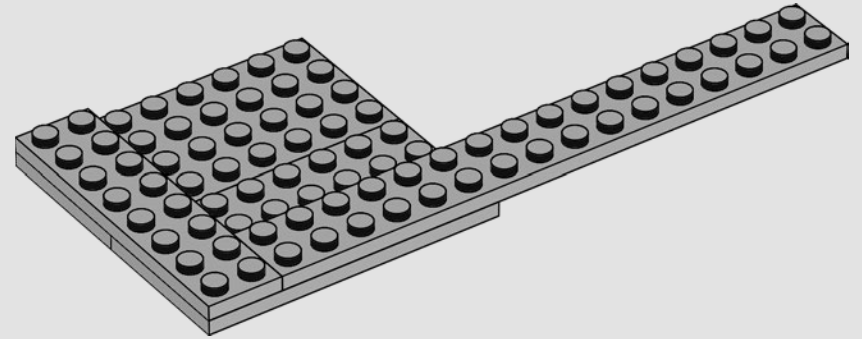

19

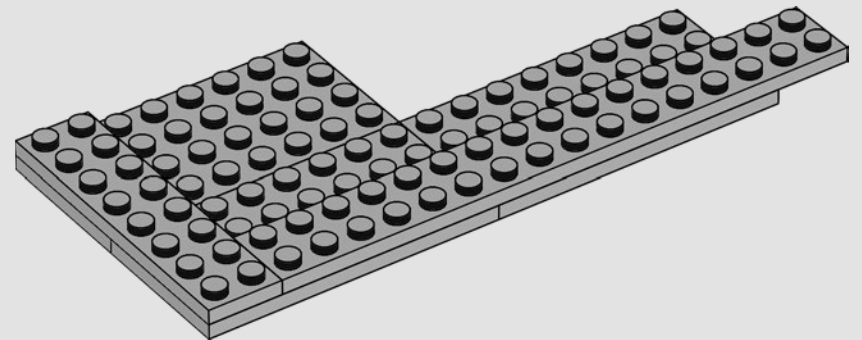

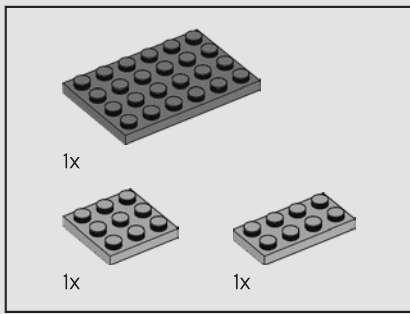

20

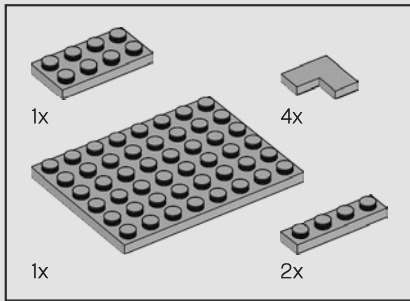
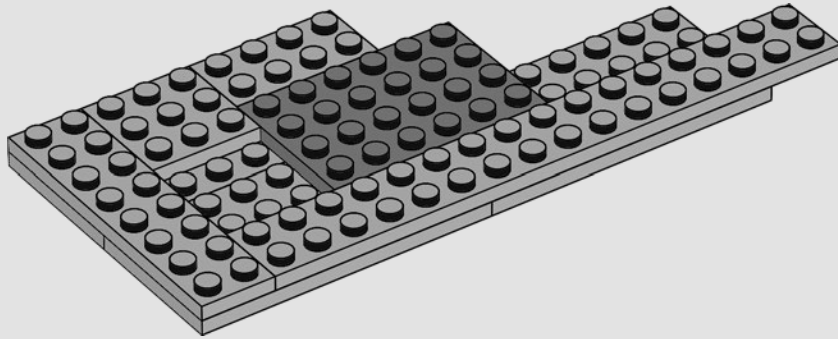

21

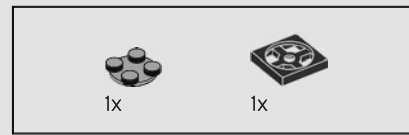
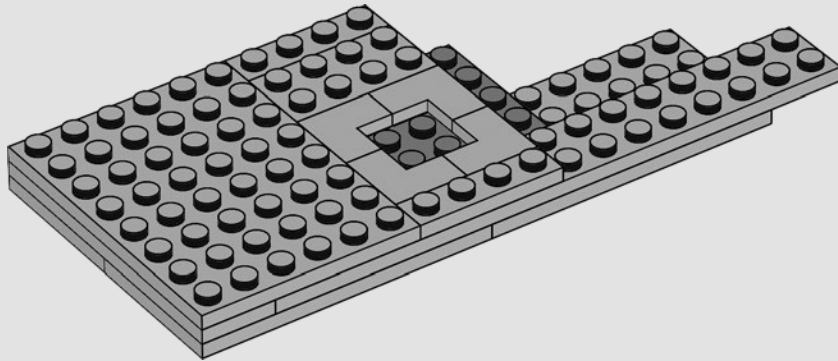

22

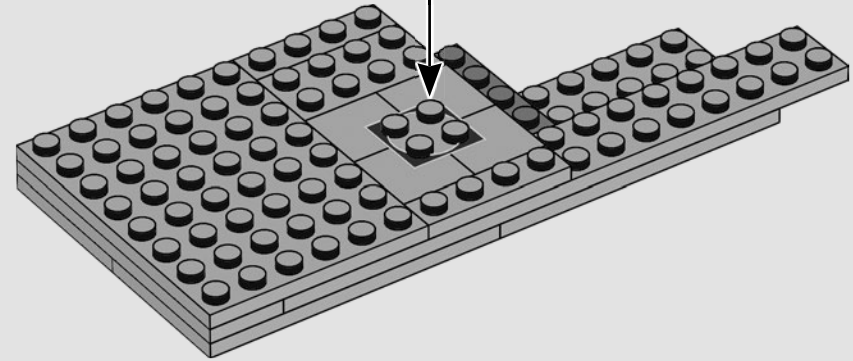
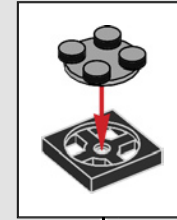



卡拉莫·布朗

“乐高®对我和我的家人具有非常特殊的意义。乐高不仅可以为我的孩子们带来数小时的玩乐体验，还是一项很棒的亲子活动，有助于增进亲子关系。”

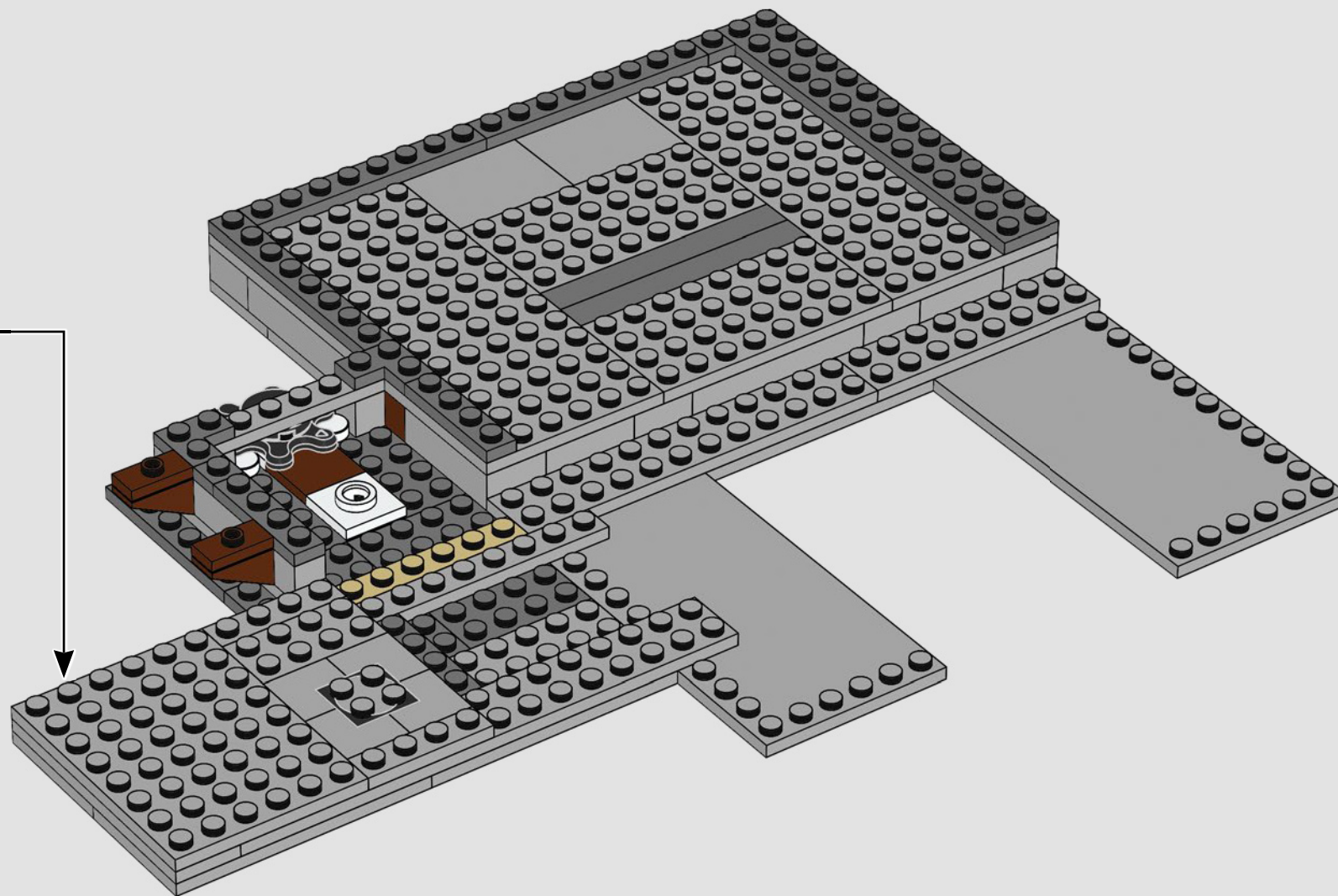

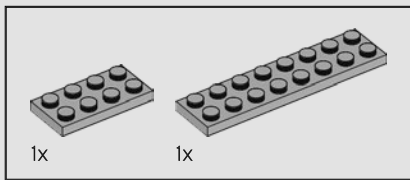

24

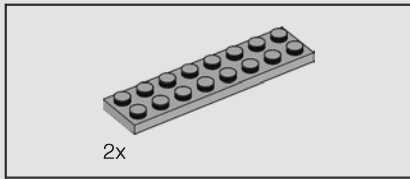
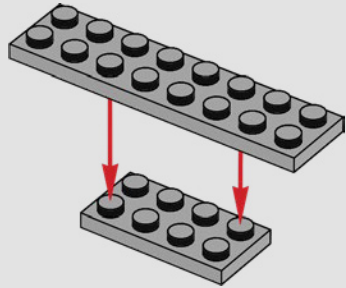

25

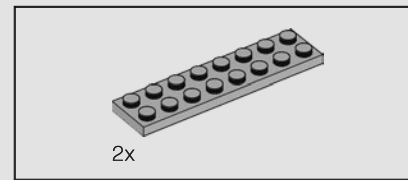
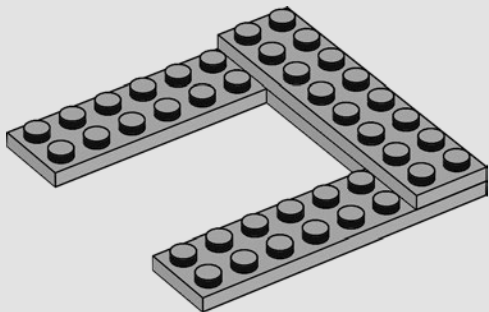

26

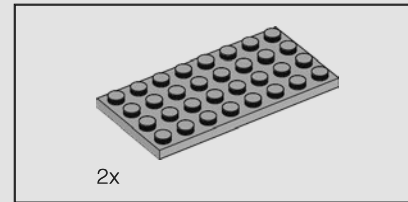
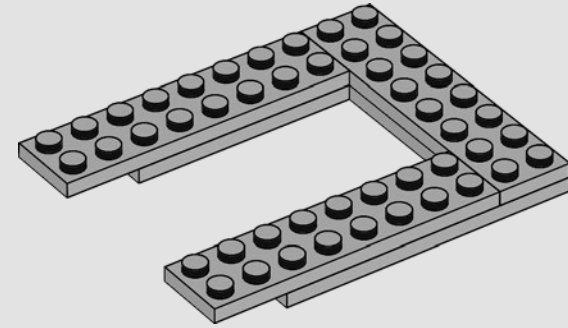

27

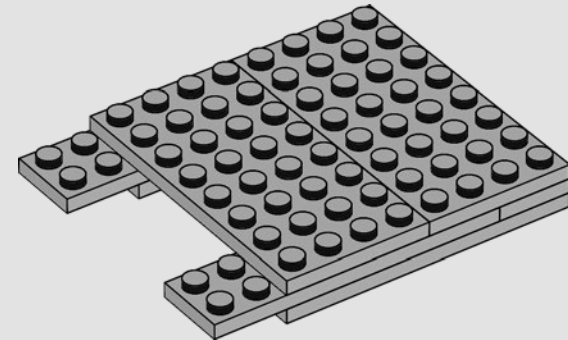

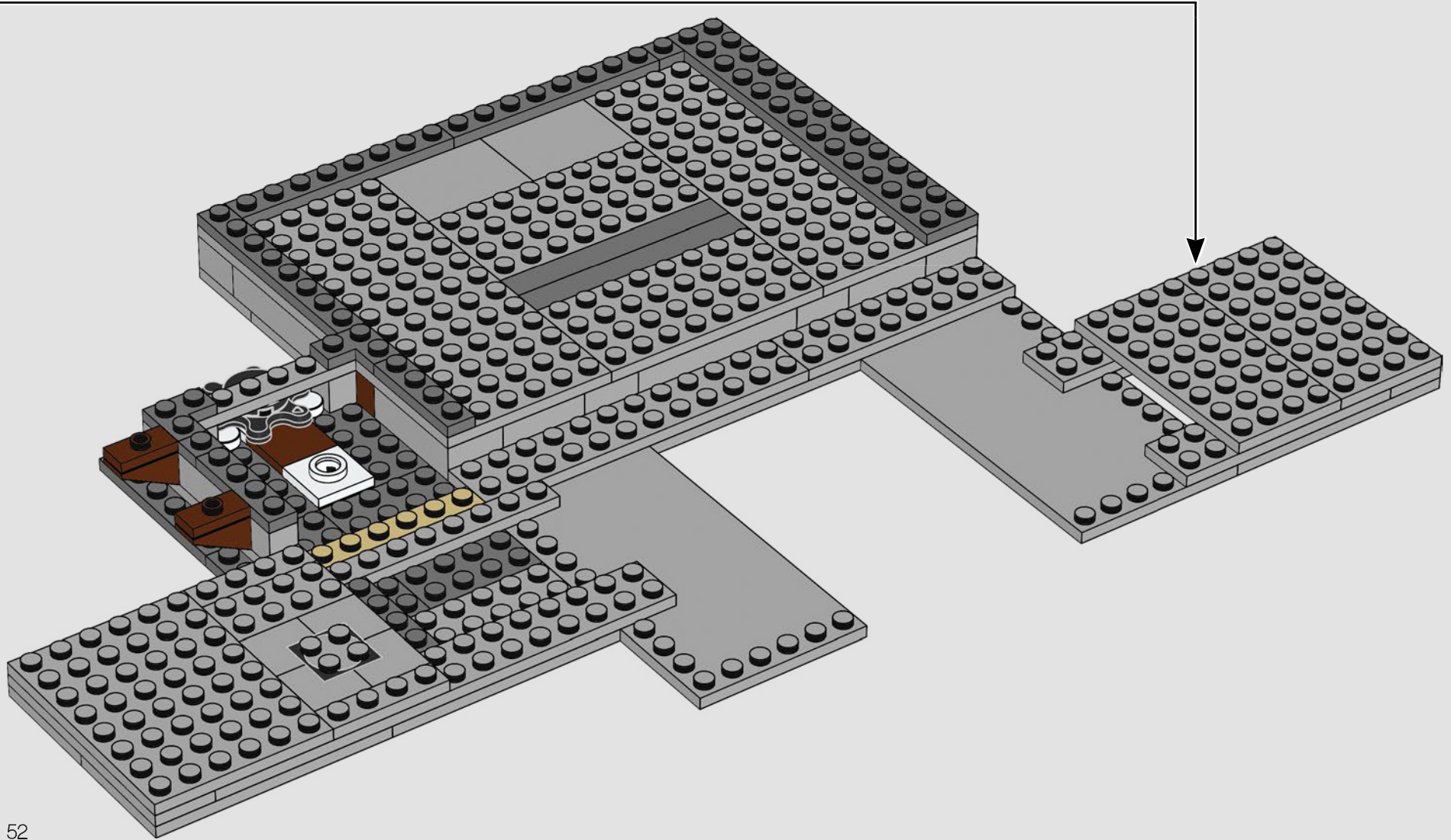

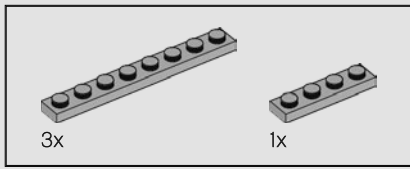

29

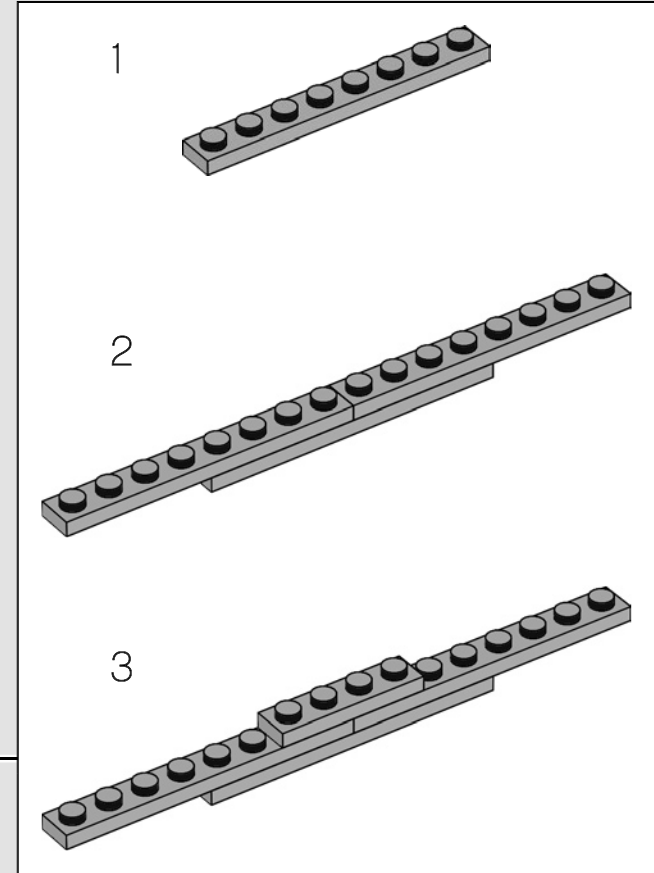
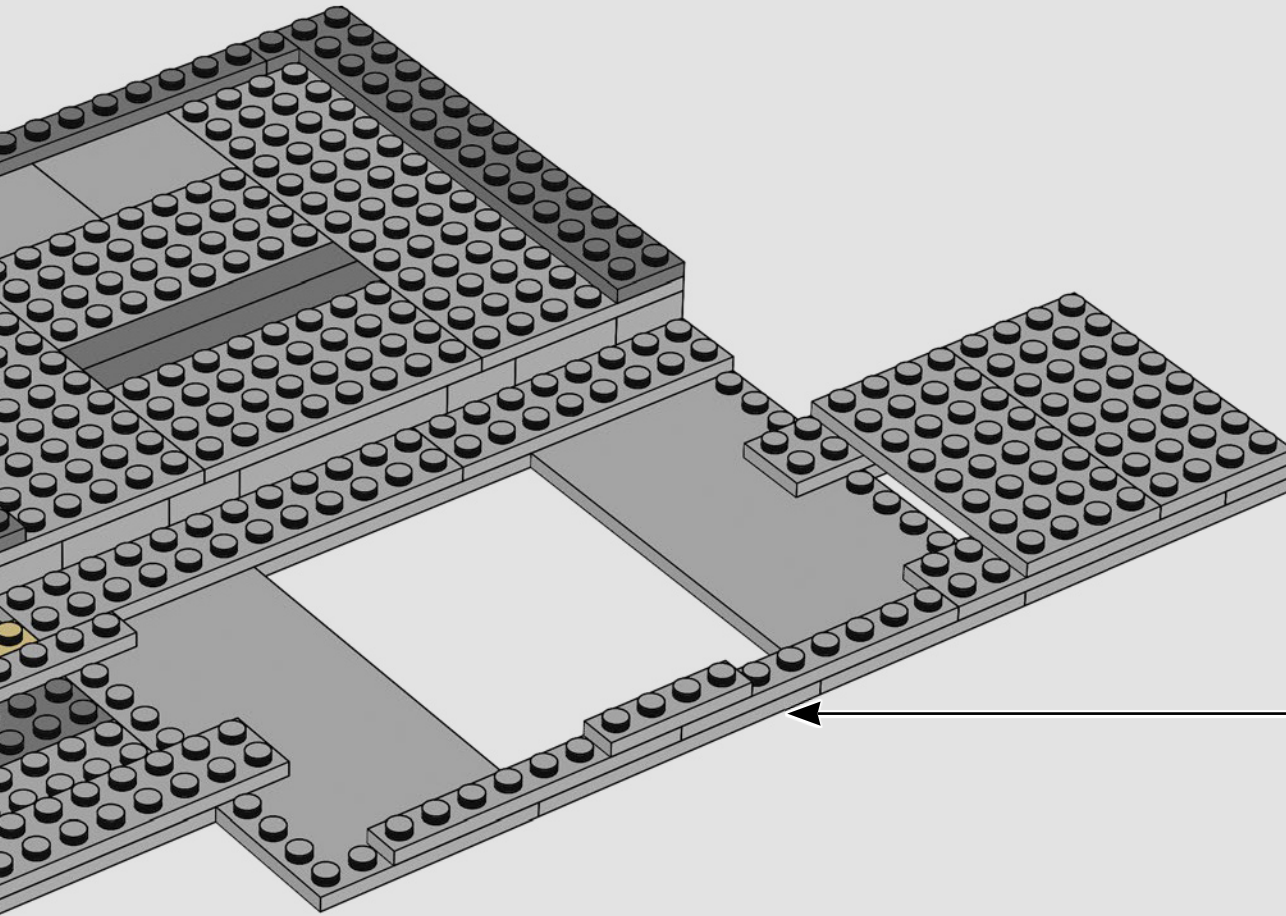

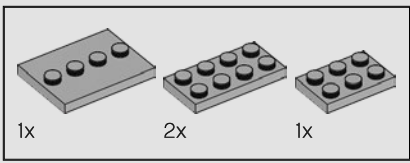

30

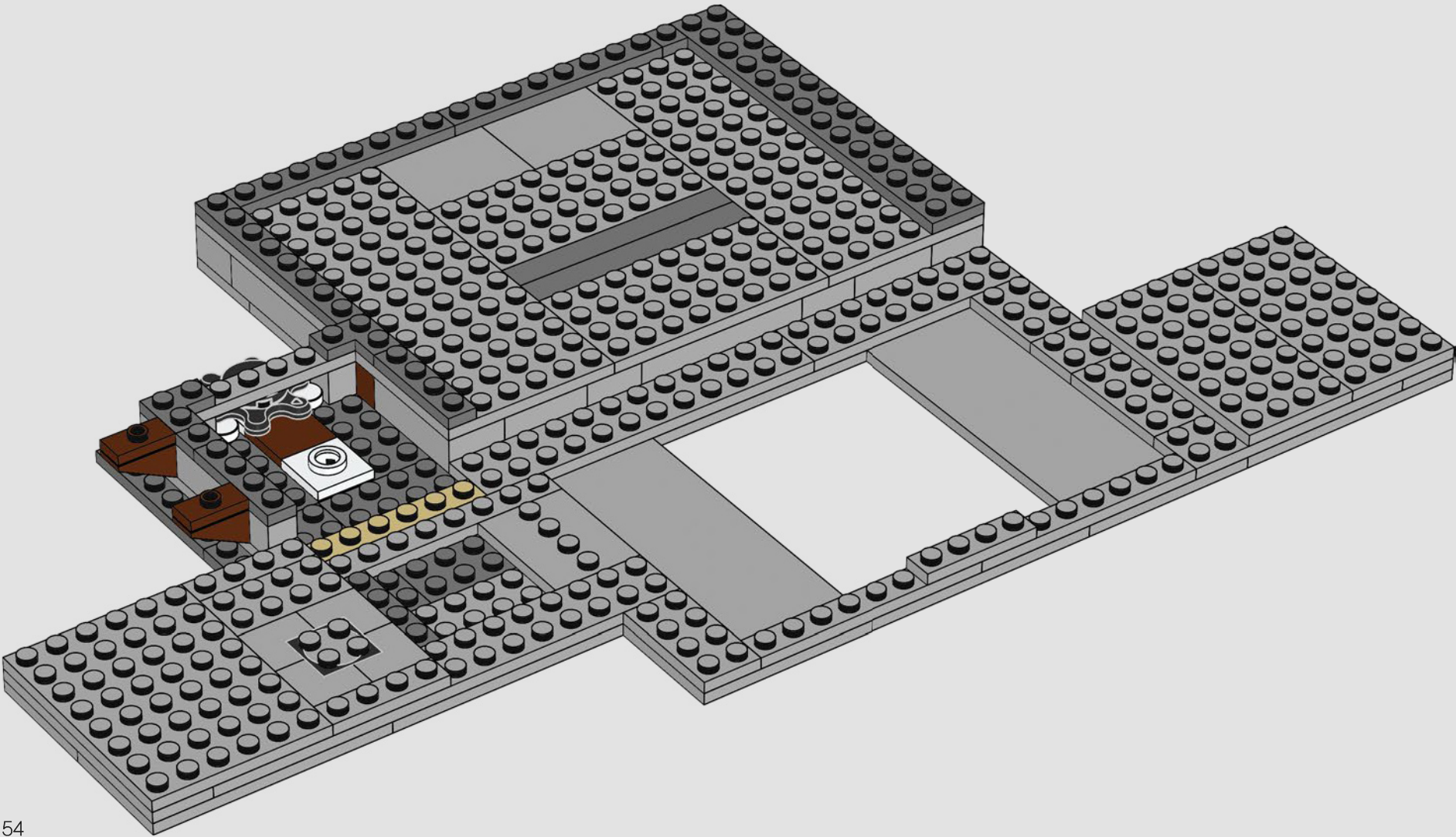

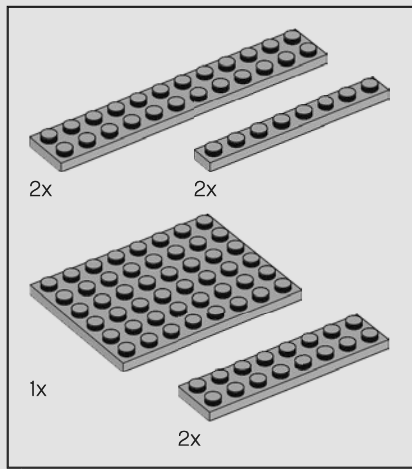

31

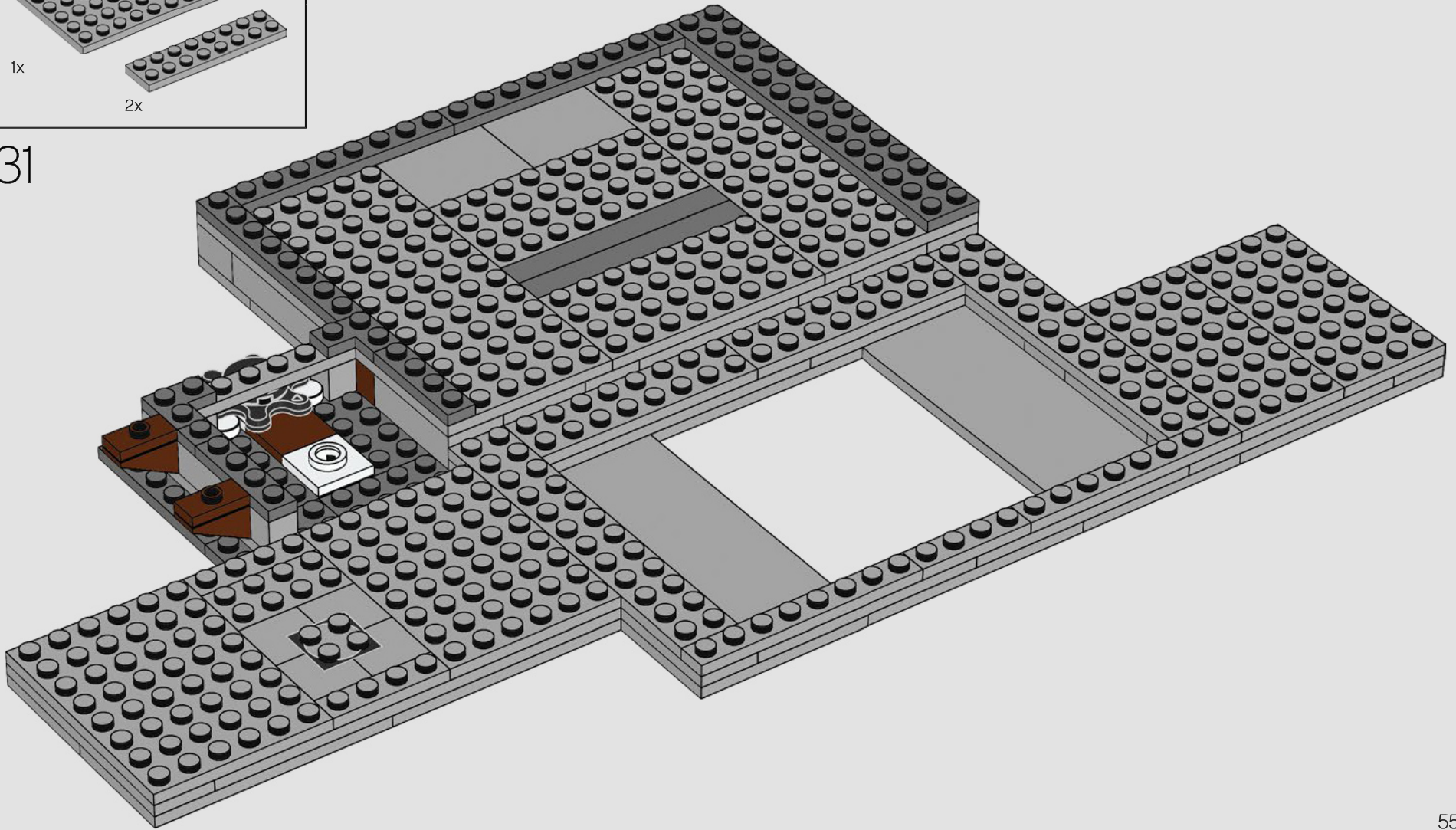

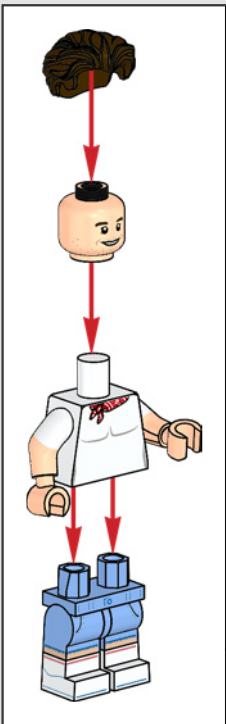
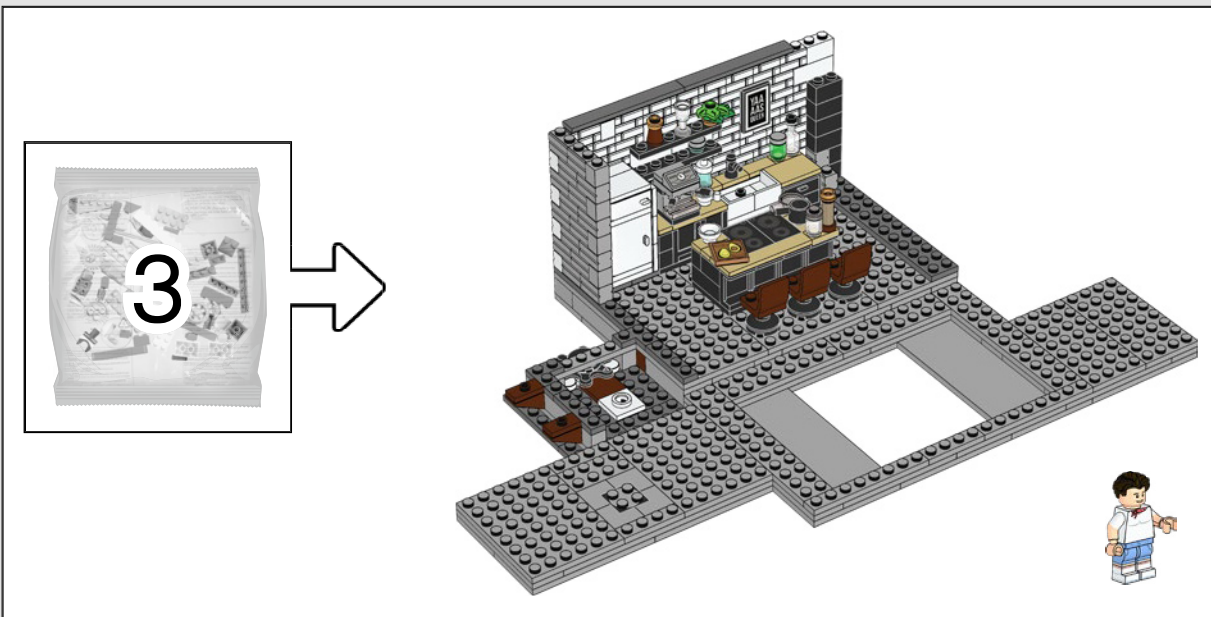

安东尼·波罗夫斯基

“非常喜欢那个小围巾，当然还有我的乐高配件：放着鳄梨的小案板。”

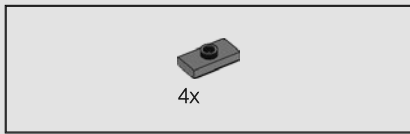

32

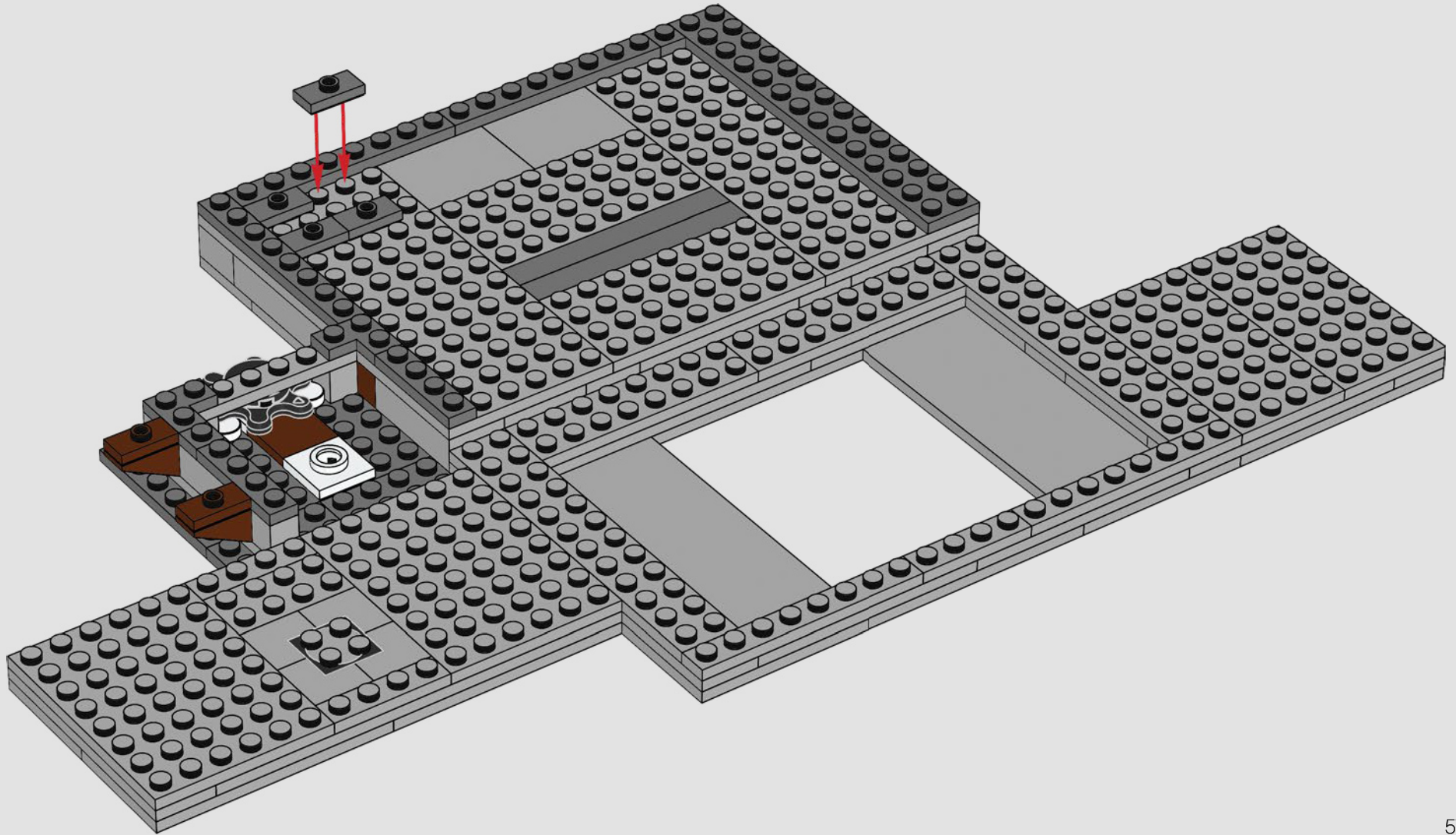

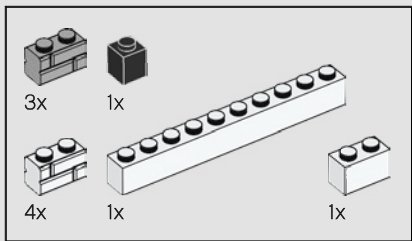

33

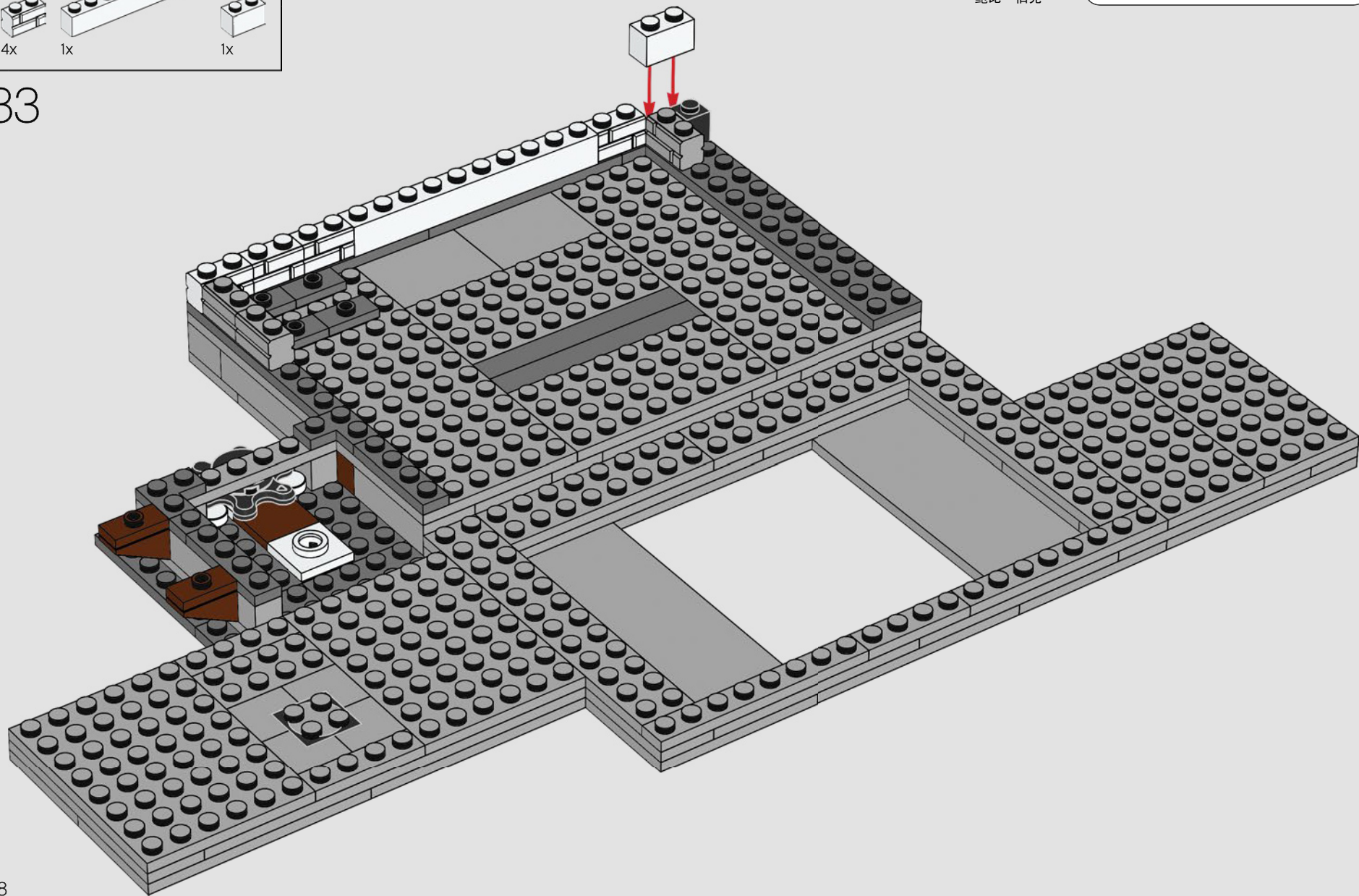

鲍比·伯克

“小时候，乐高®点燃了我内心的创意火焰，让我觉得生活中一切皆有可能，就像我能够用积木拼搭出无穷无尽的事物一样。”

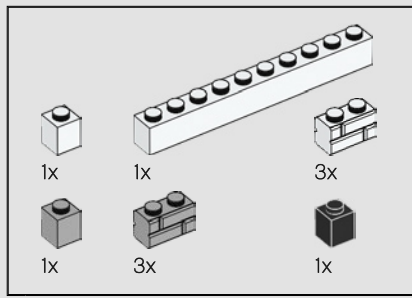

34

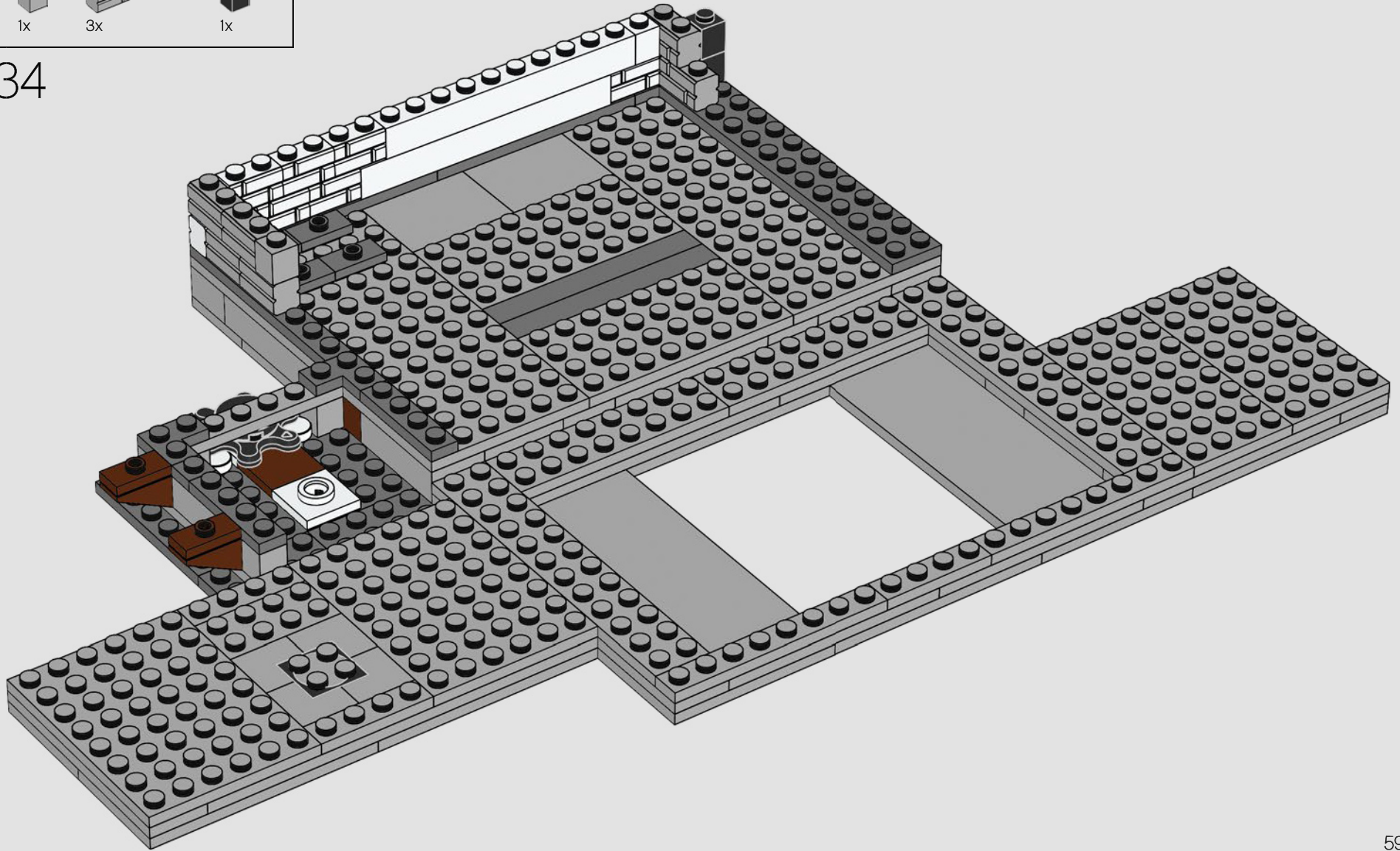

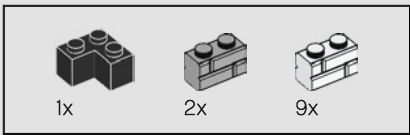

35

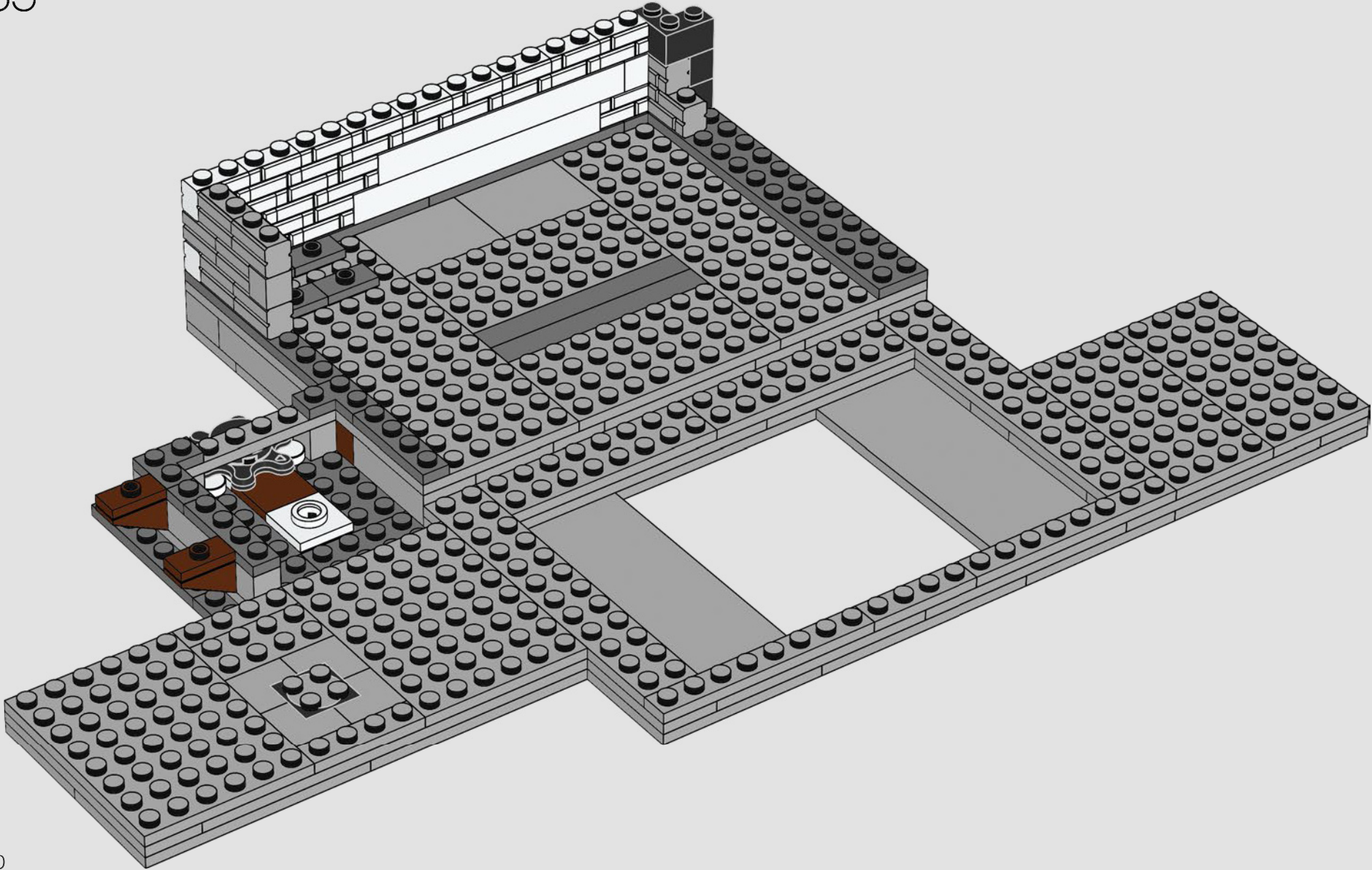

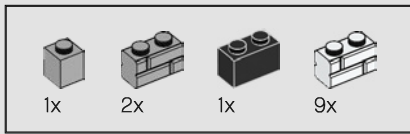

36

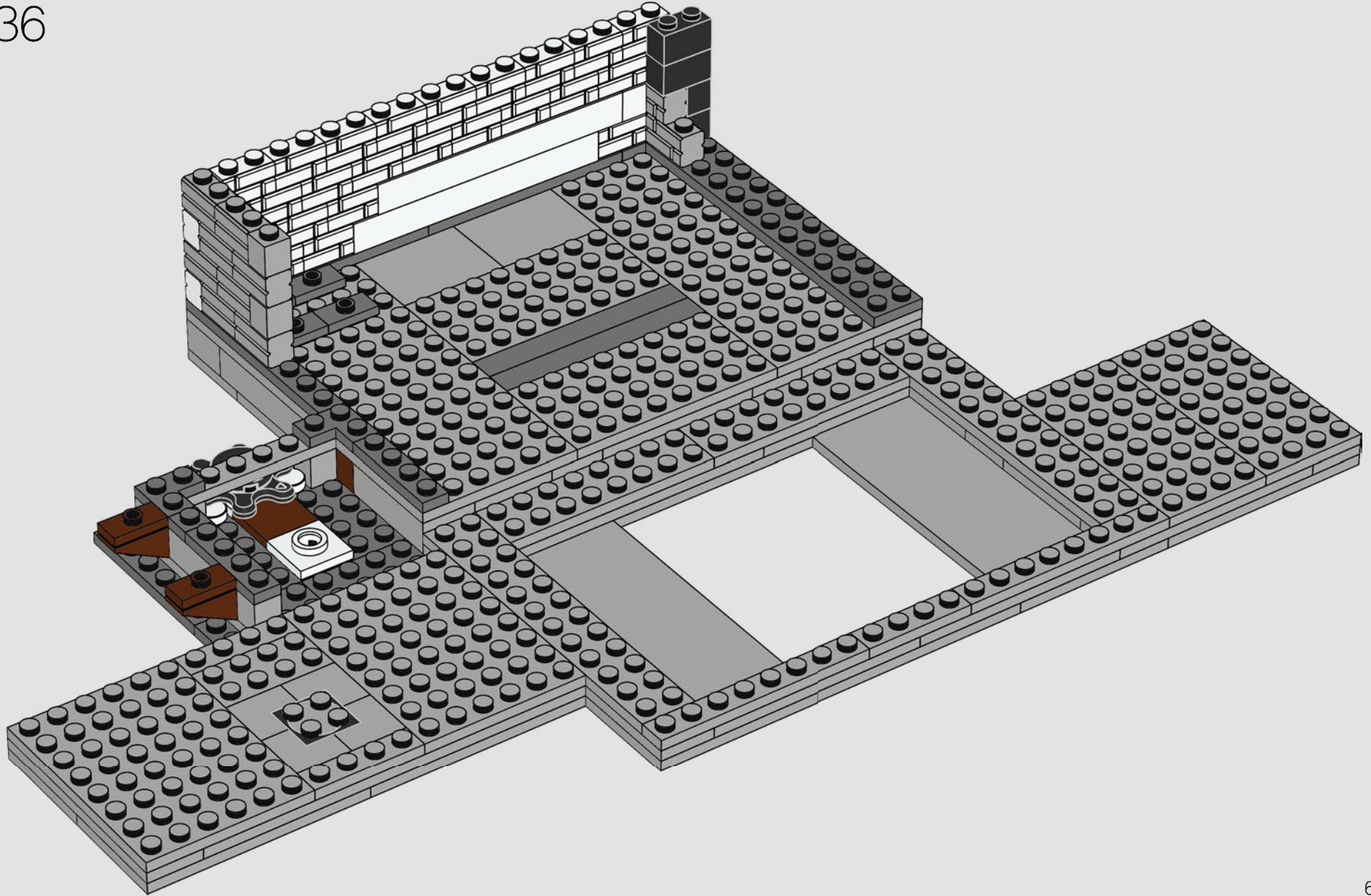

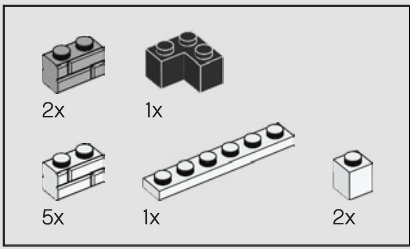

37



鲍比·伯克

“能够制作一个不仅成功而且能够帮助数百万人更加热爱自己和他人的节目，是我一生最大的荣幸。”

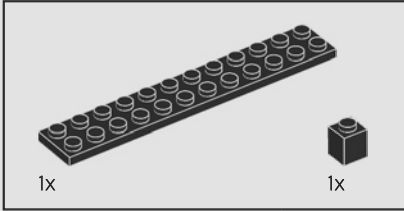
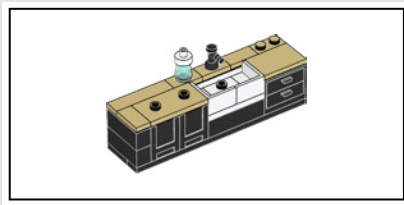

38

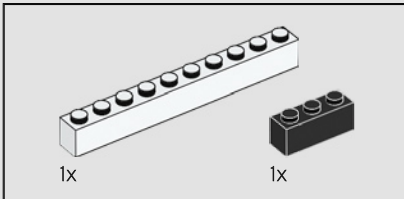
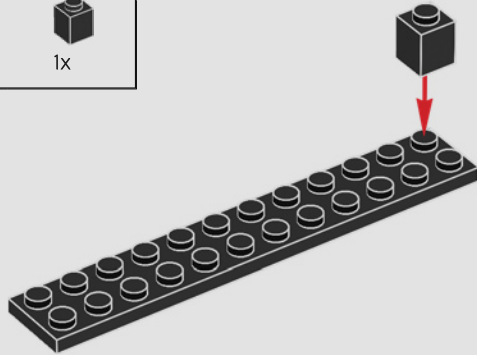

39

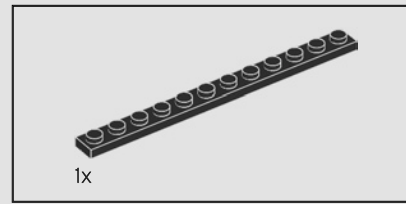
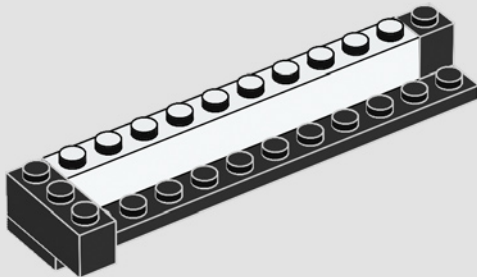

40

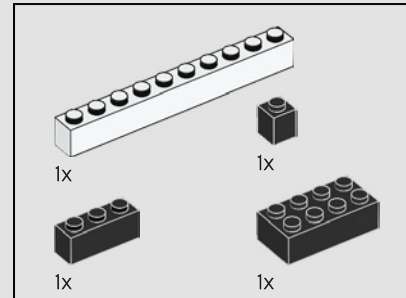
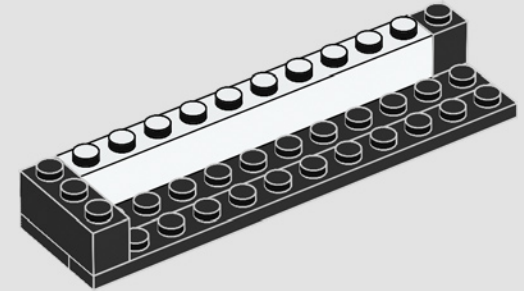

41

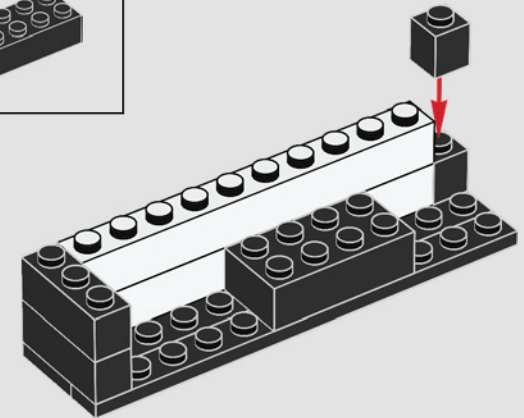

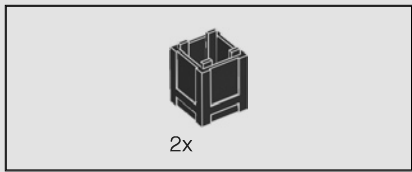

42

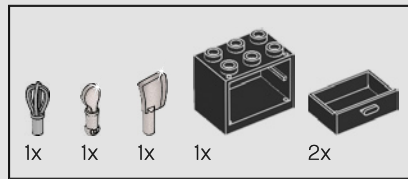
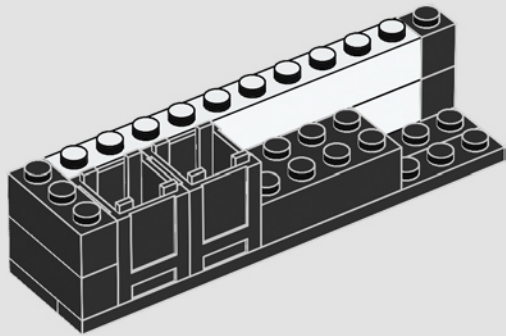

43

1

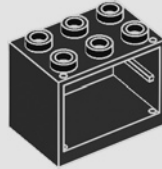

2

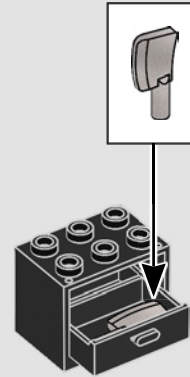

3

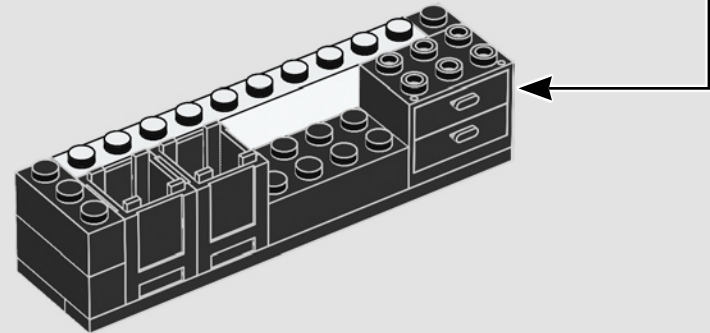
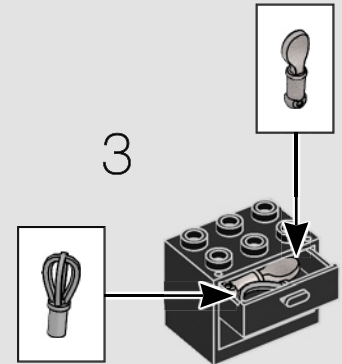

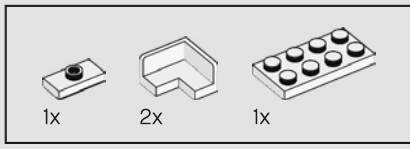

44

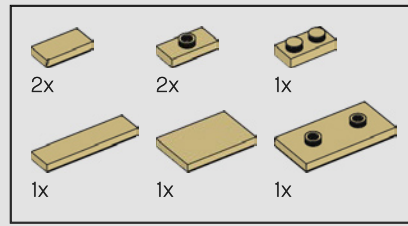
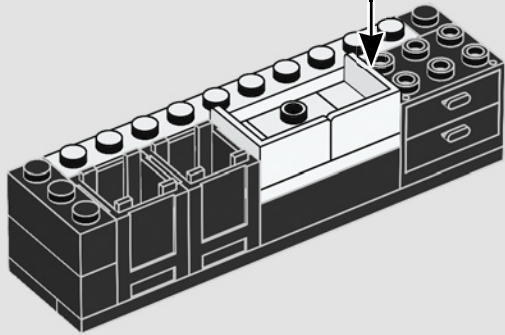
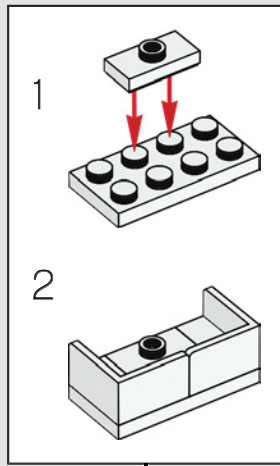

45

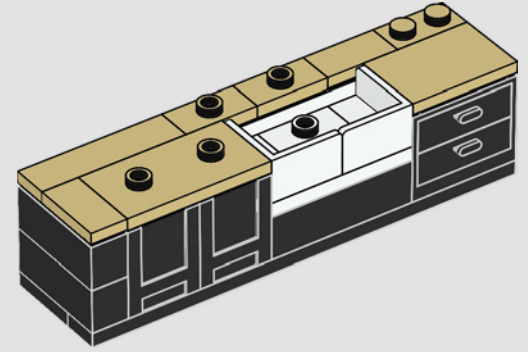

46

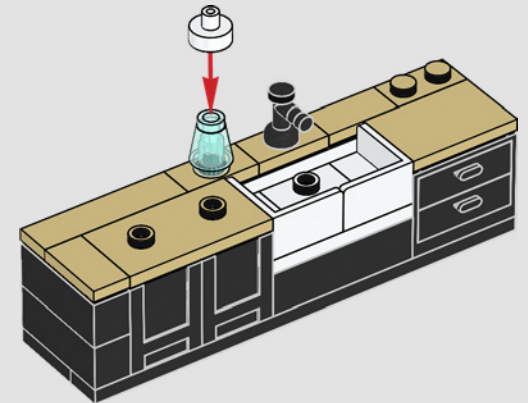

47

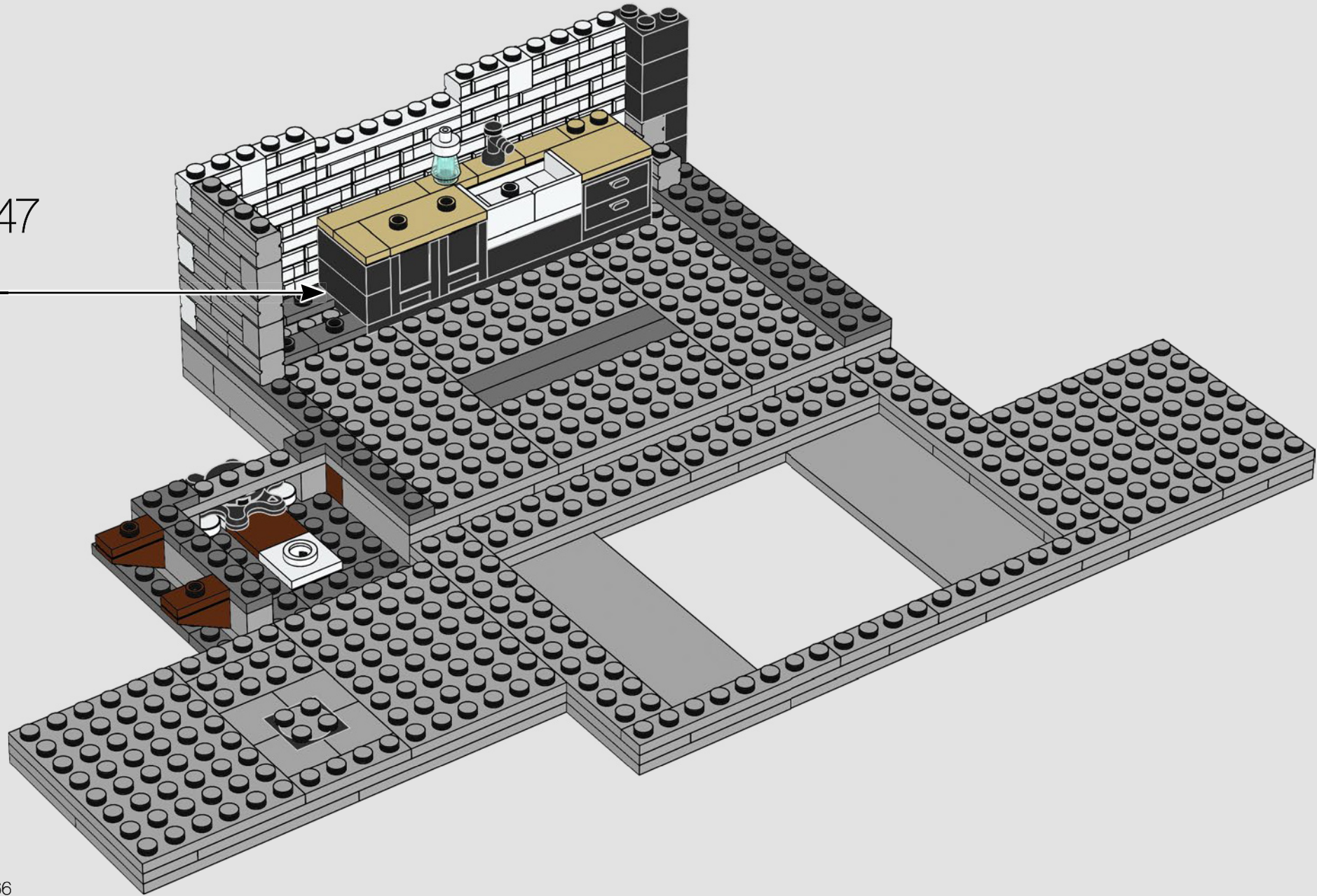

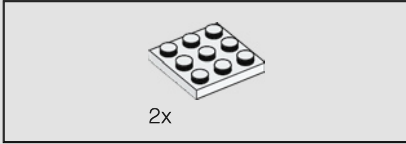
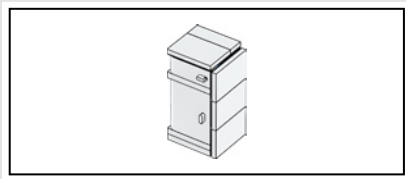

48

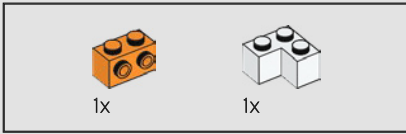
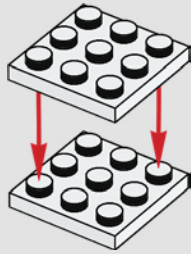

49

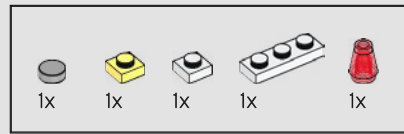
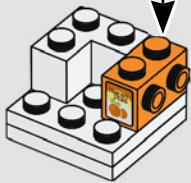
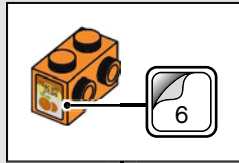

50

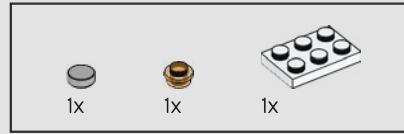
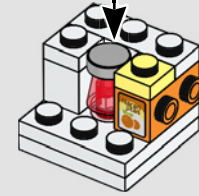
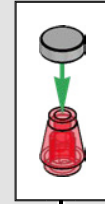

51

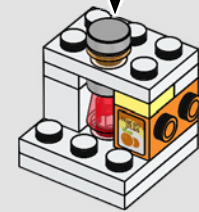
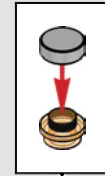

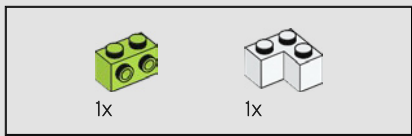

52

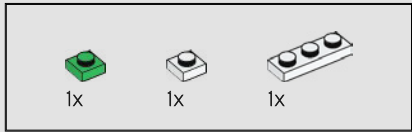
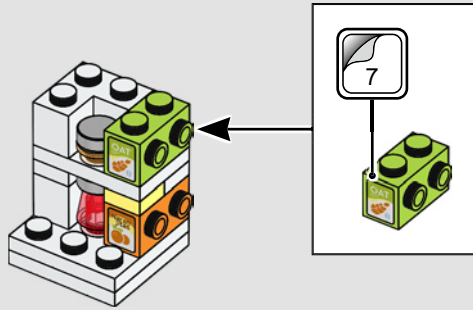

53

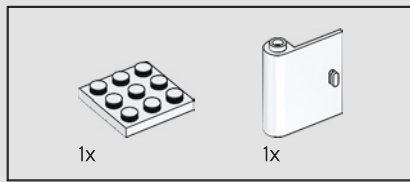

54

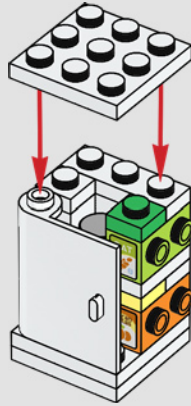

55

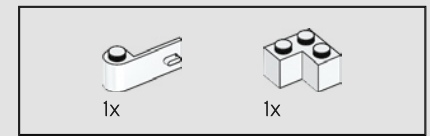
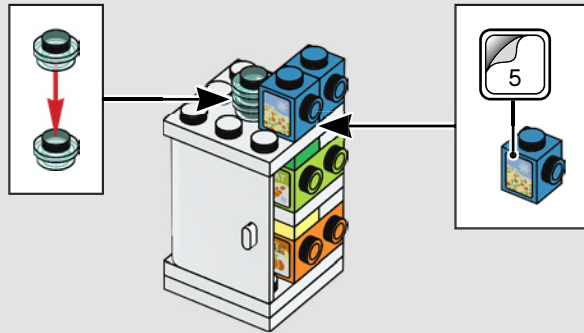

56

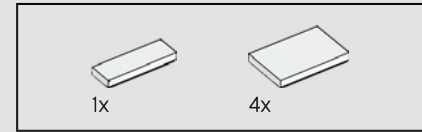

57





安东尼·波罗夫斯基

“拼搭乐高”积木在某些方面非常像做饭。当然，你既可以按照说明制作‘经过反复尝试和测试’的理想成品，也可以进行所有实验并创造出自己的作品。”



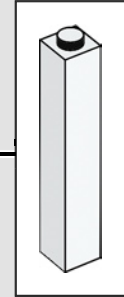
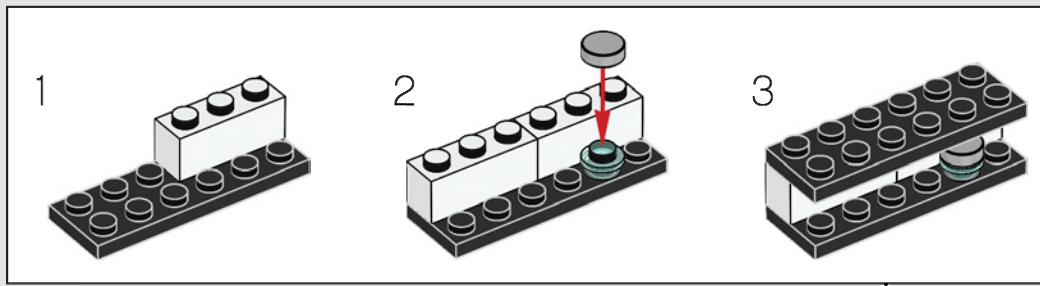
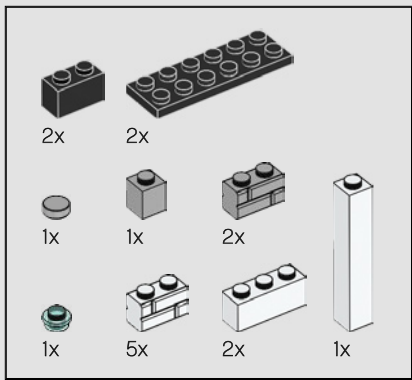

59

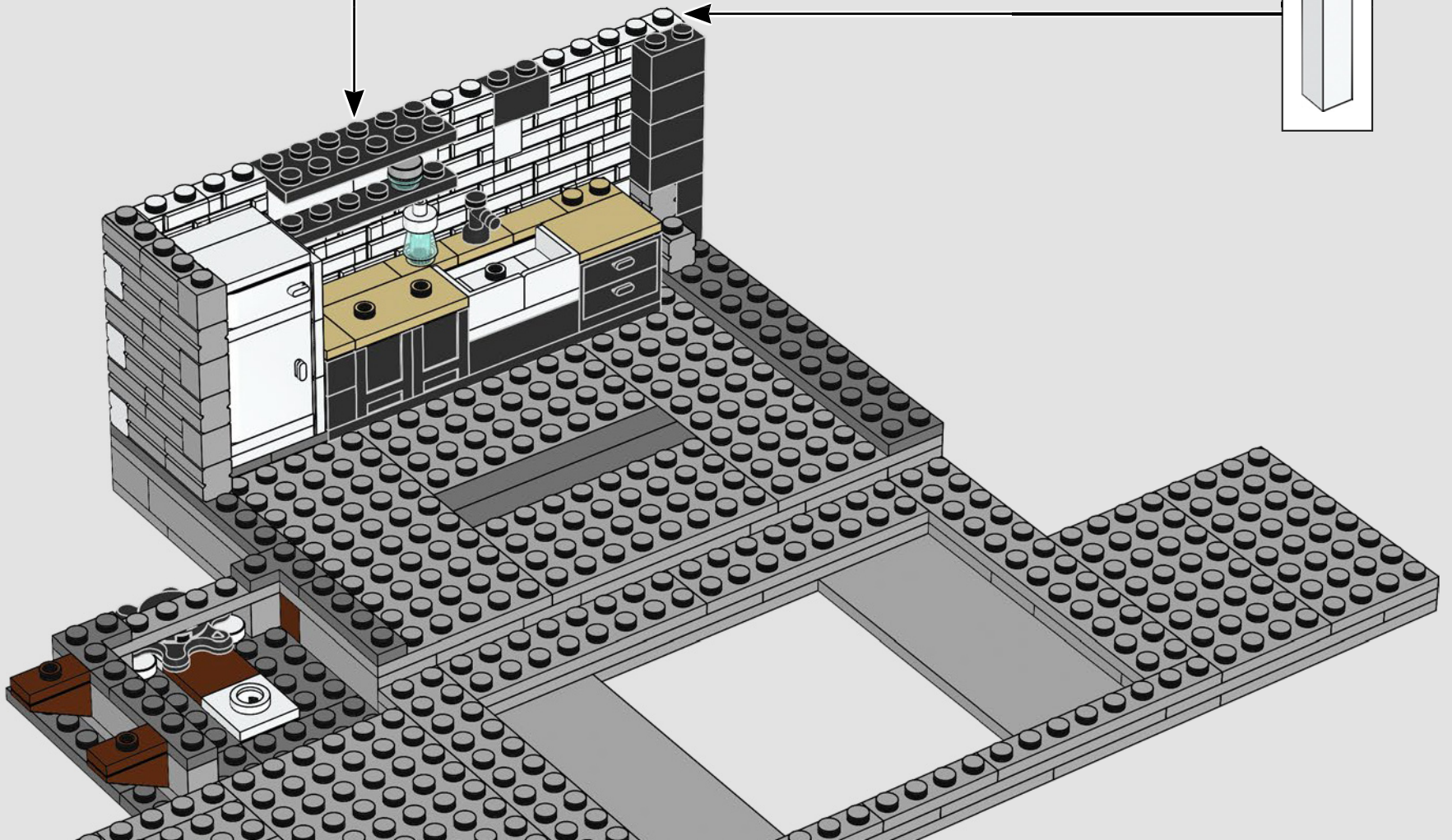

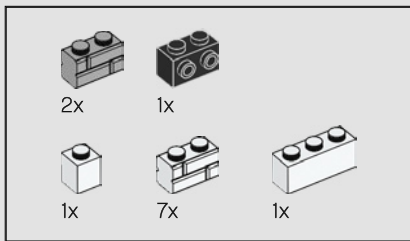

60

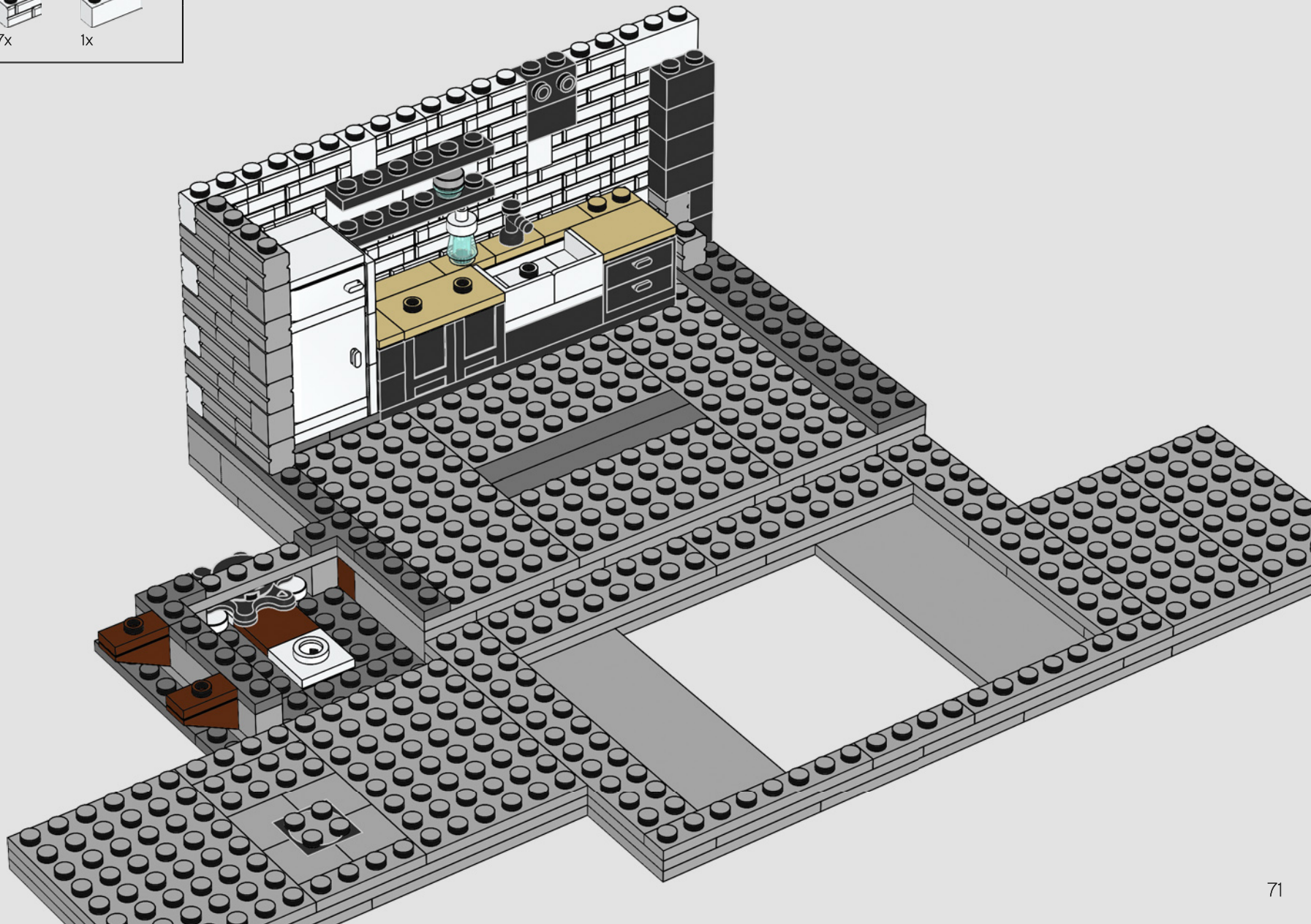

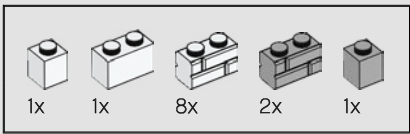

61



鲍比·伯克

“在《粉雄救兵》上，我们的工作流程一直都是：全新的开始，重塑，充分利用已有的物品——还有什么比乐高®更适合的玩具来展现这些呢？”



62

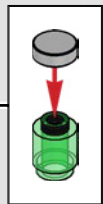
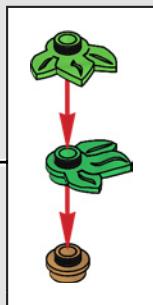
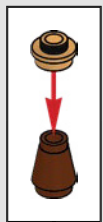
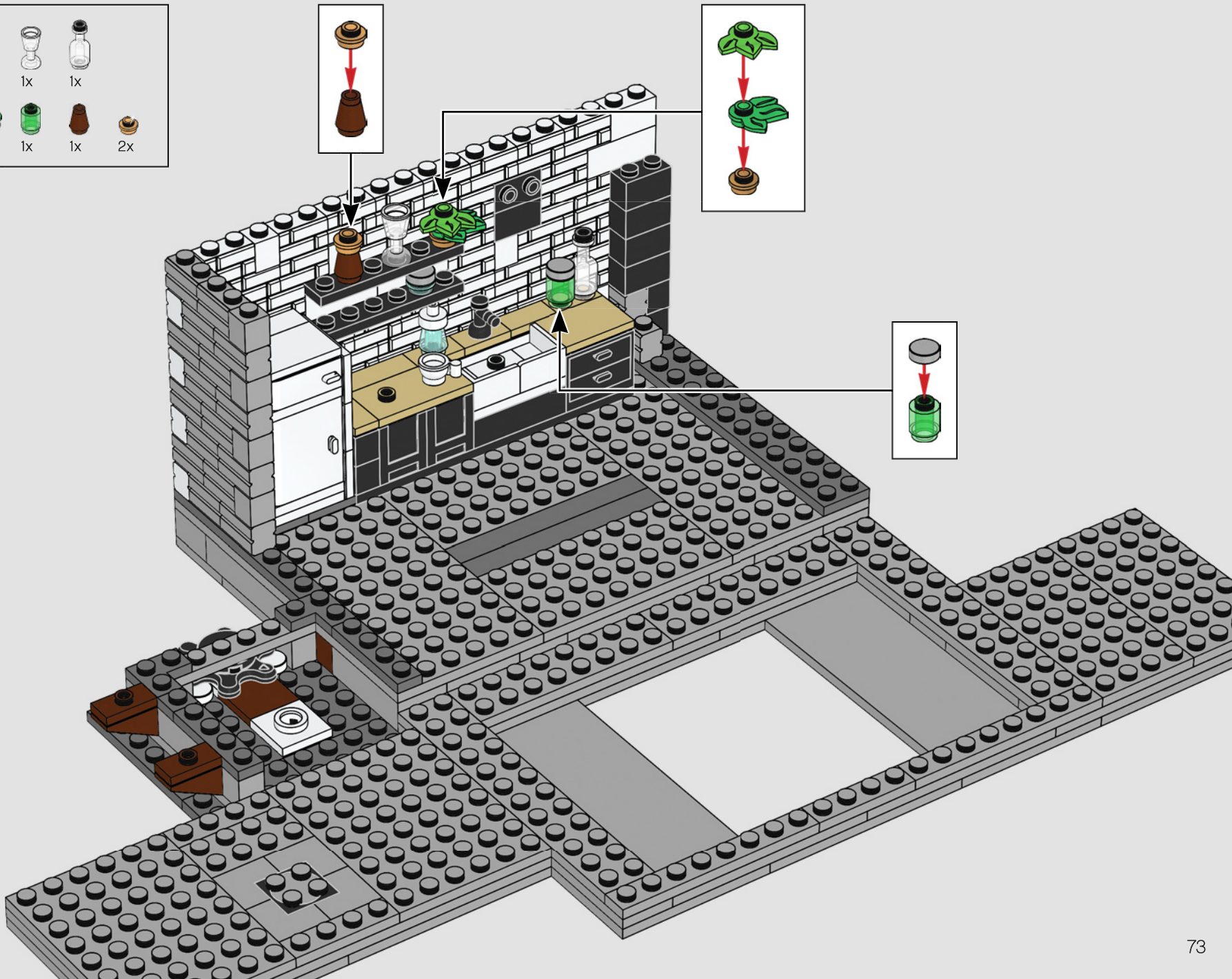

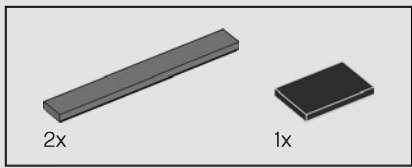

63

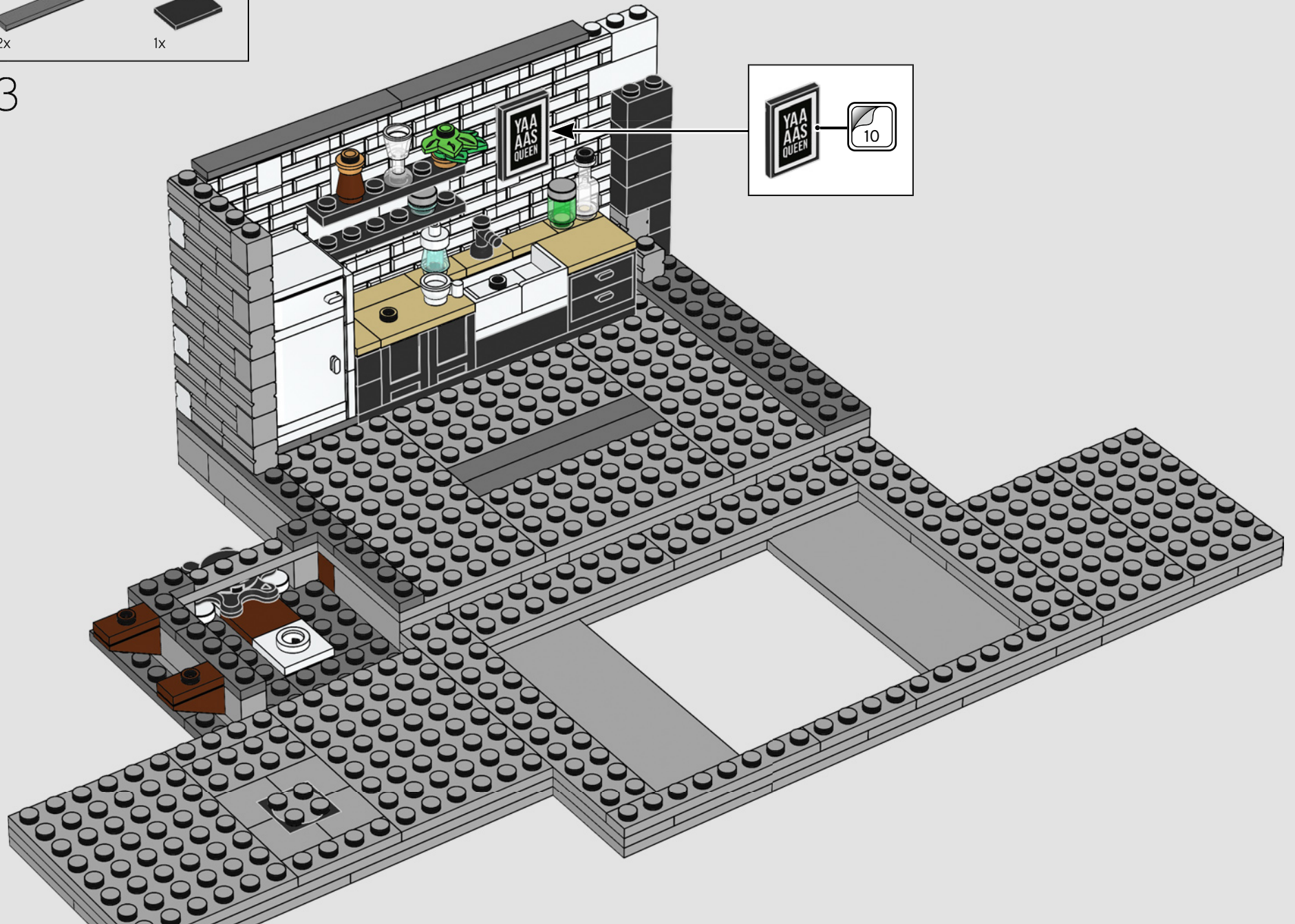

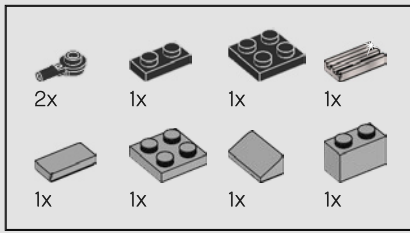

64

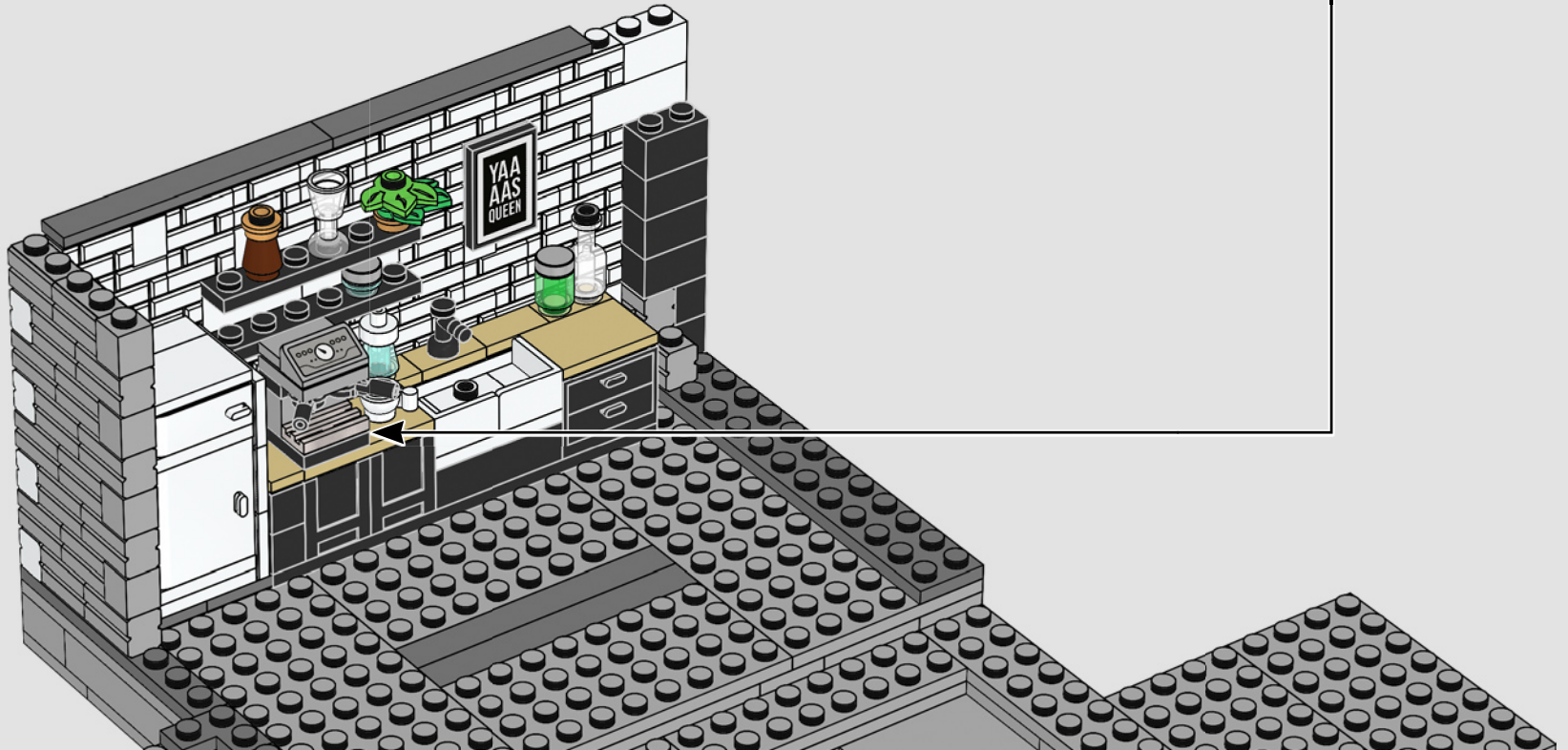
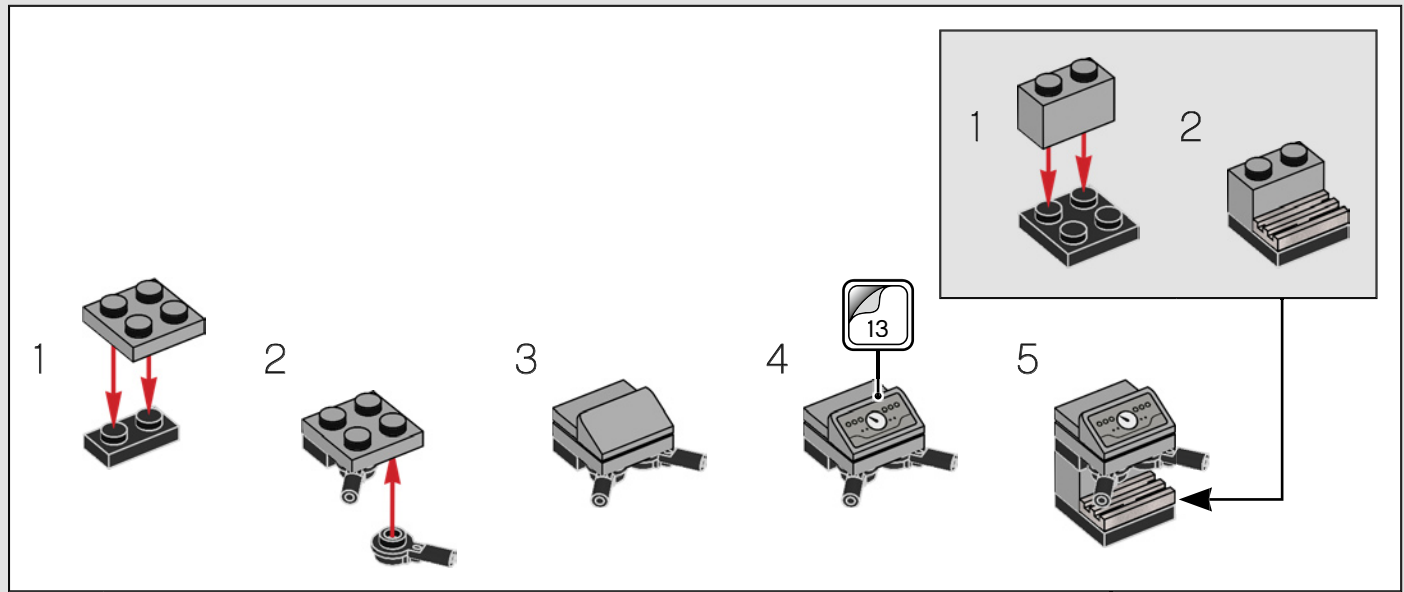

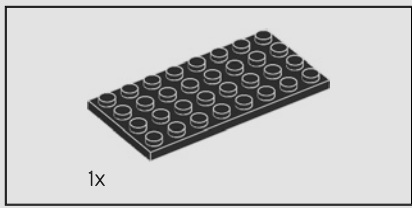

65

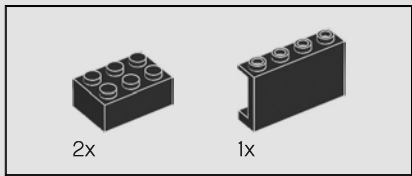
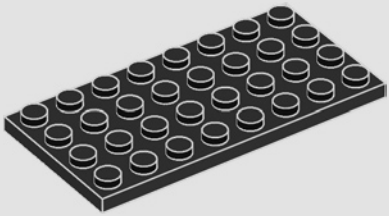

66

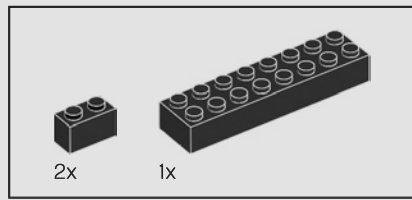
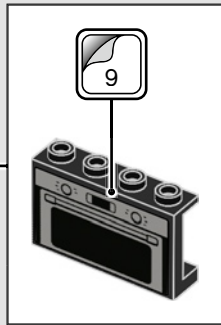
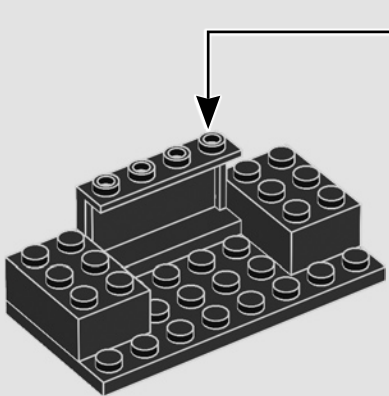

67

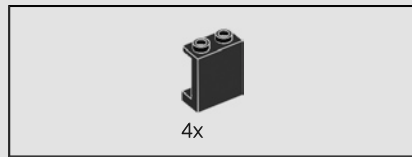
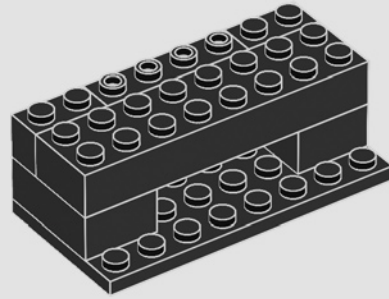

68

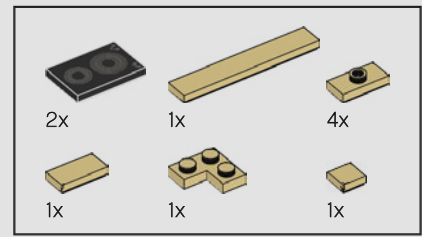
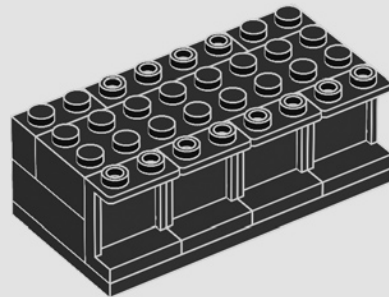

69

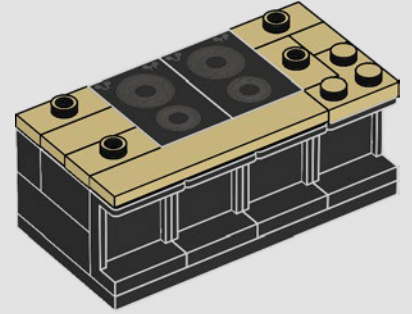

70

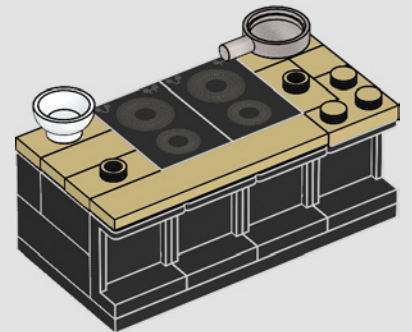

71

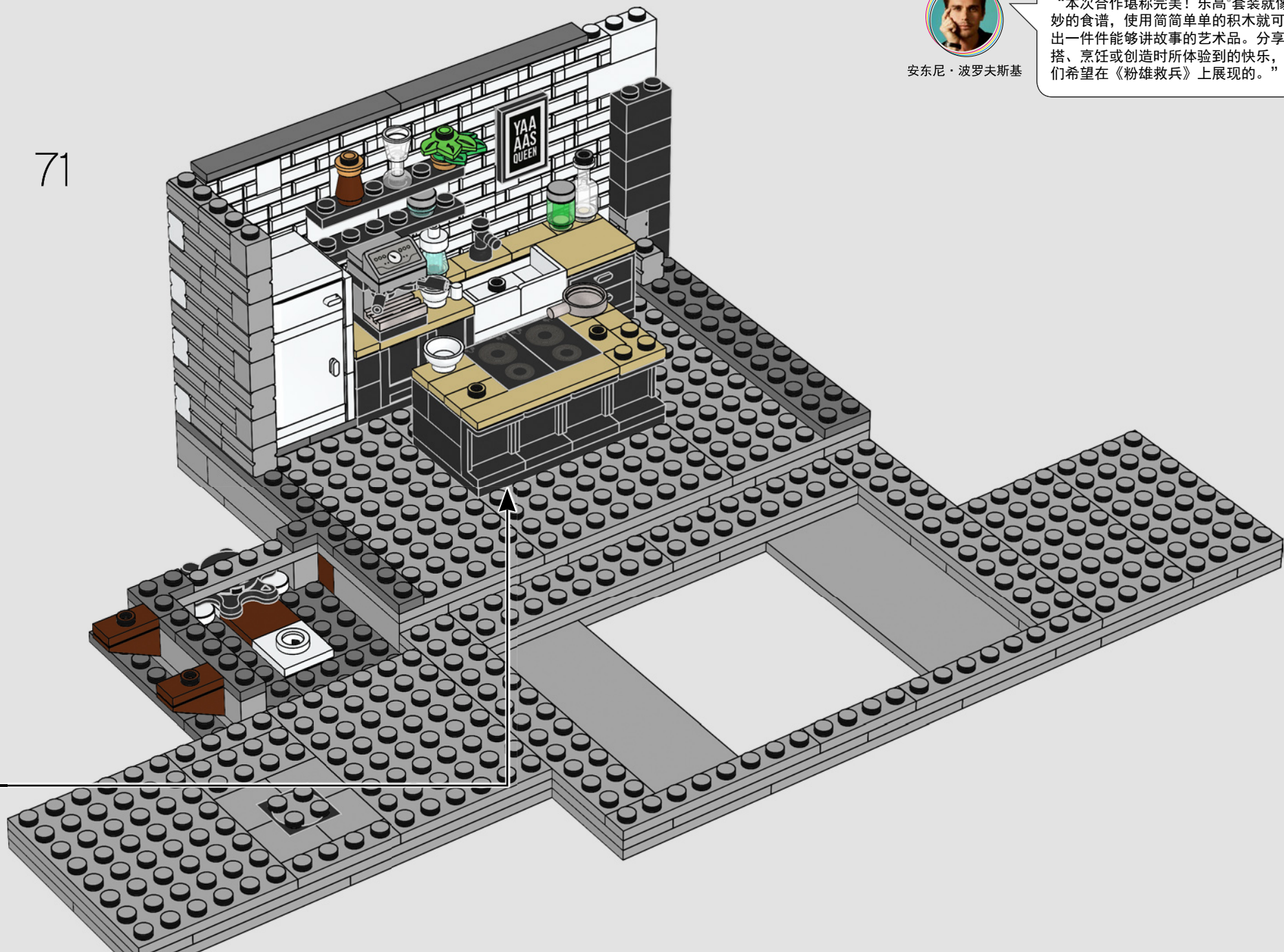

安东尼·波罗夫斯基

“本次合作堪称完美！乐高®套装就像一份美妙的食谱，使用简简单单的积木就可以拼搭出一件件能够讲故事的艺术品。分享你在拼搭、烹饪或创造时所体验到的快乐，正是我们希望在《粉雄救兵》上展现的。”

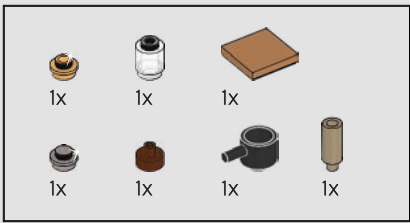

72

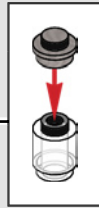
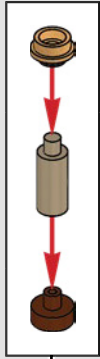
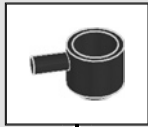
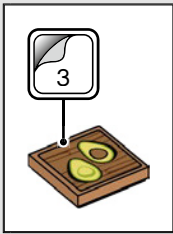

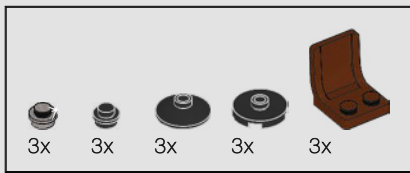

73

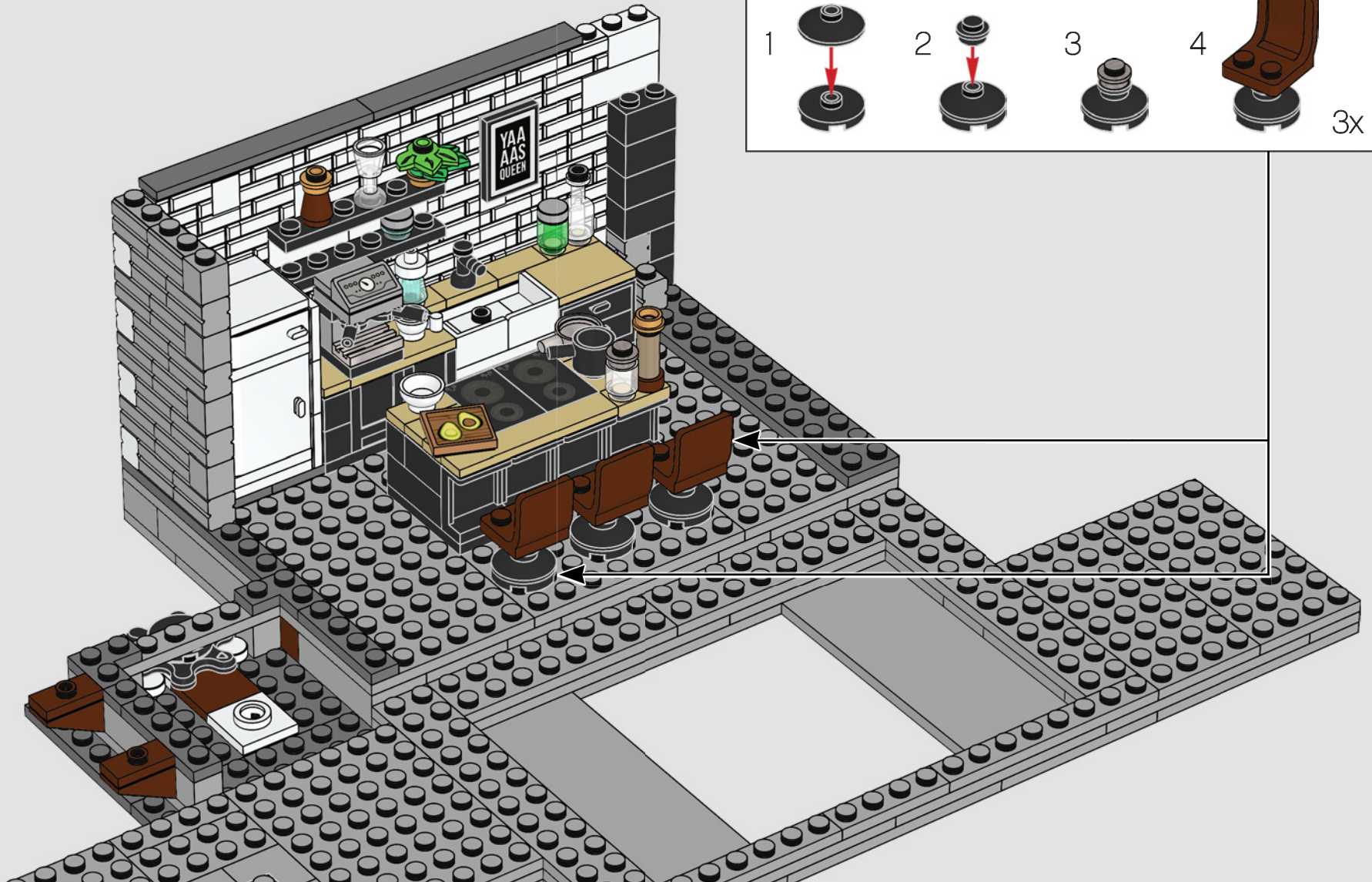
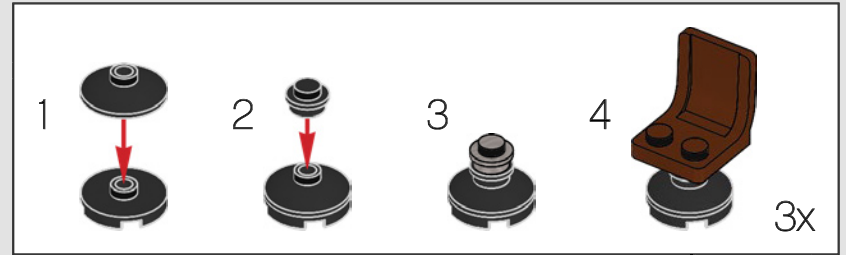

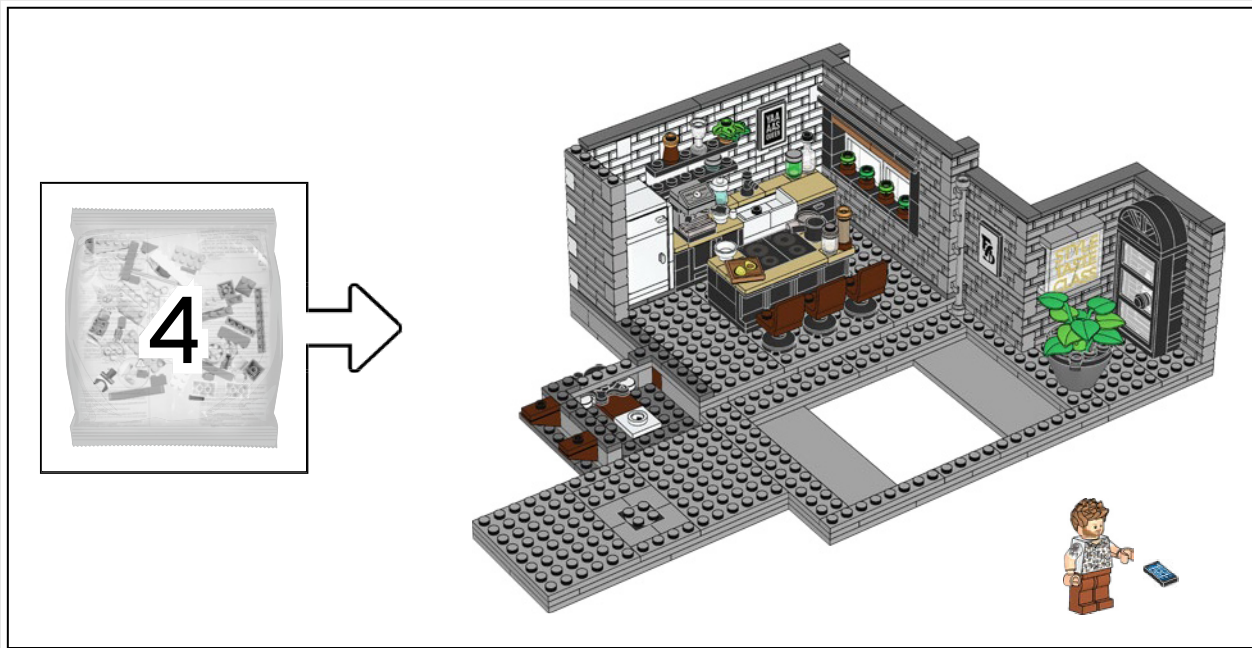

鲍比·伯克

“看到自己的乐高”小人仔版本，简直太超现实了！如果 7 岁的我知道这件事，肯定会开心得发狂！”



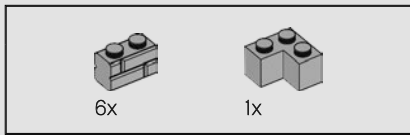

74



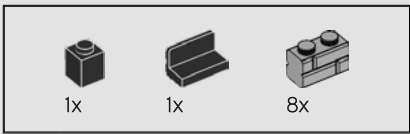

75

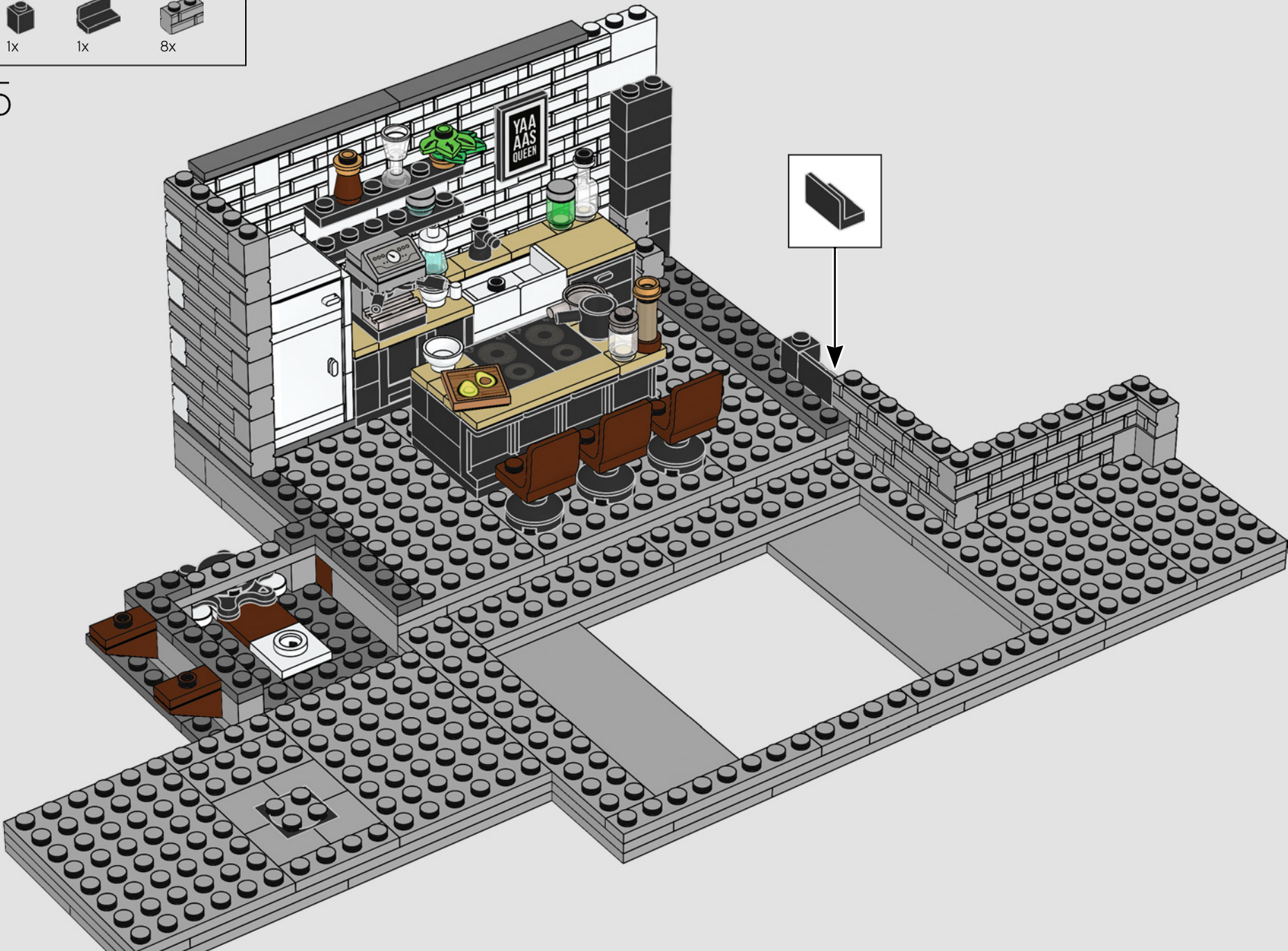

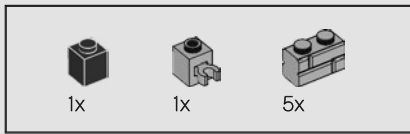

76

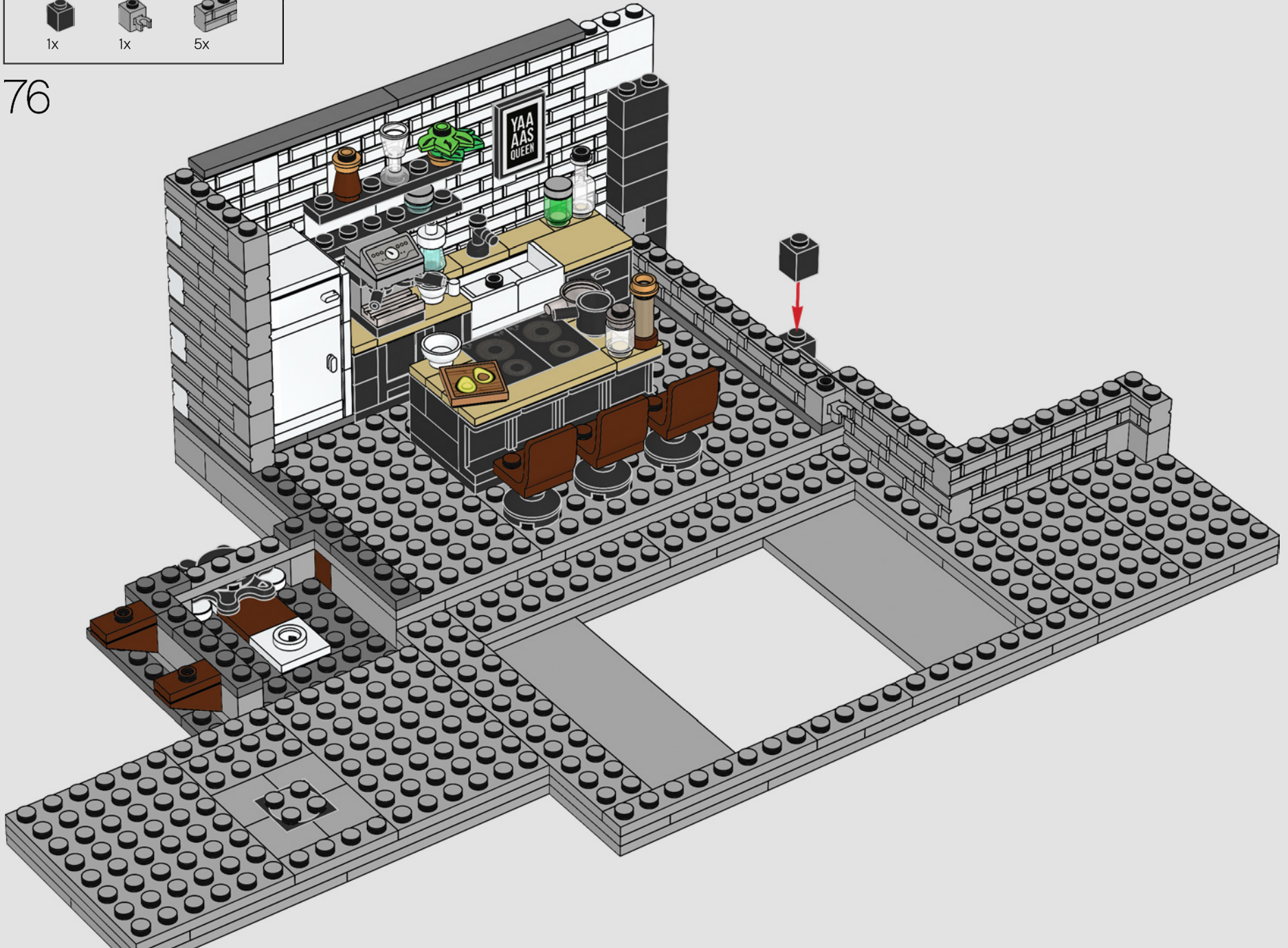

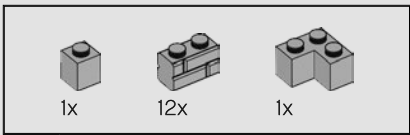

77

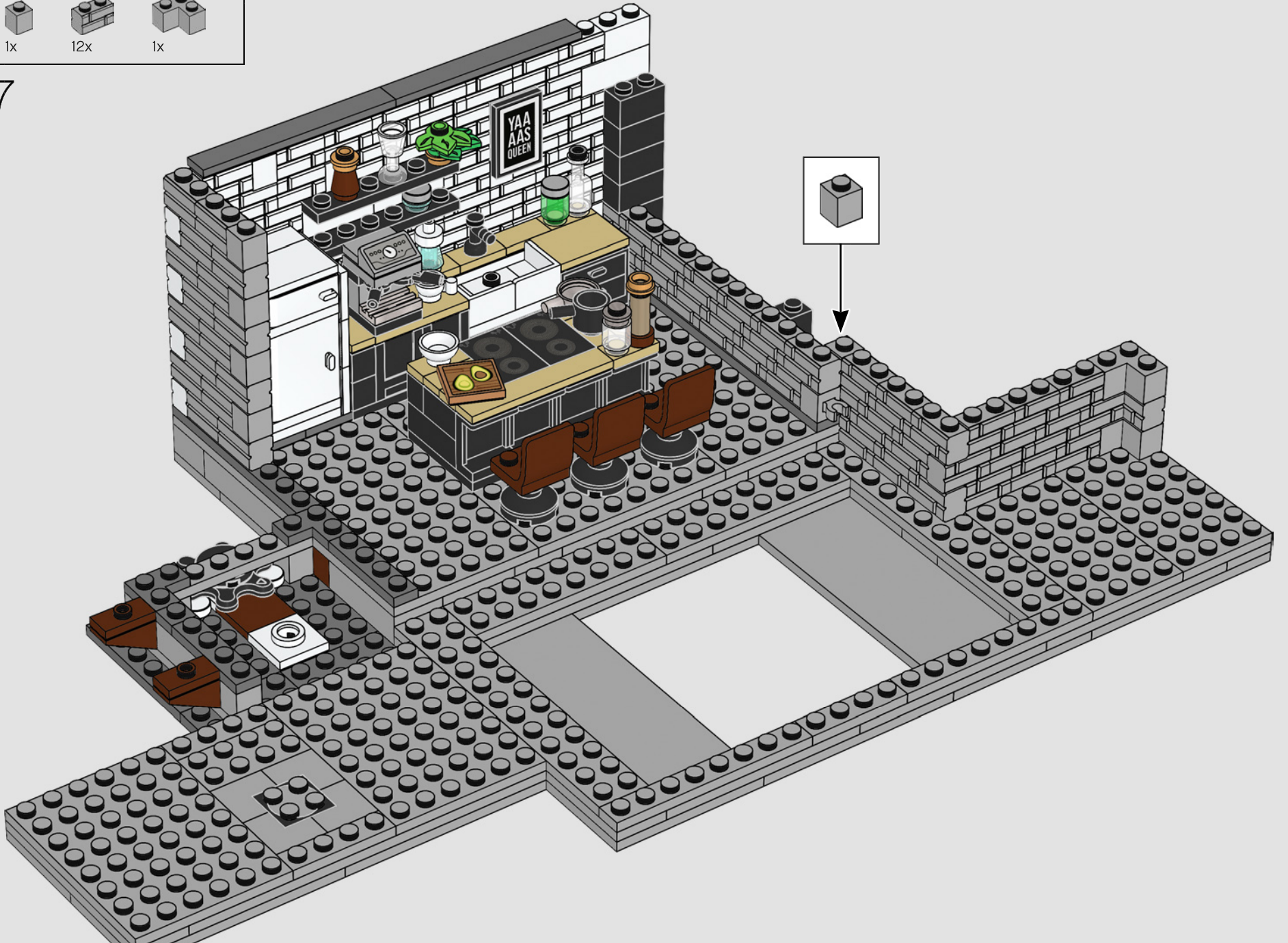



78

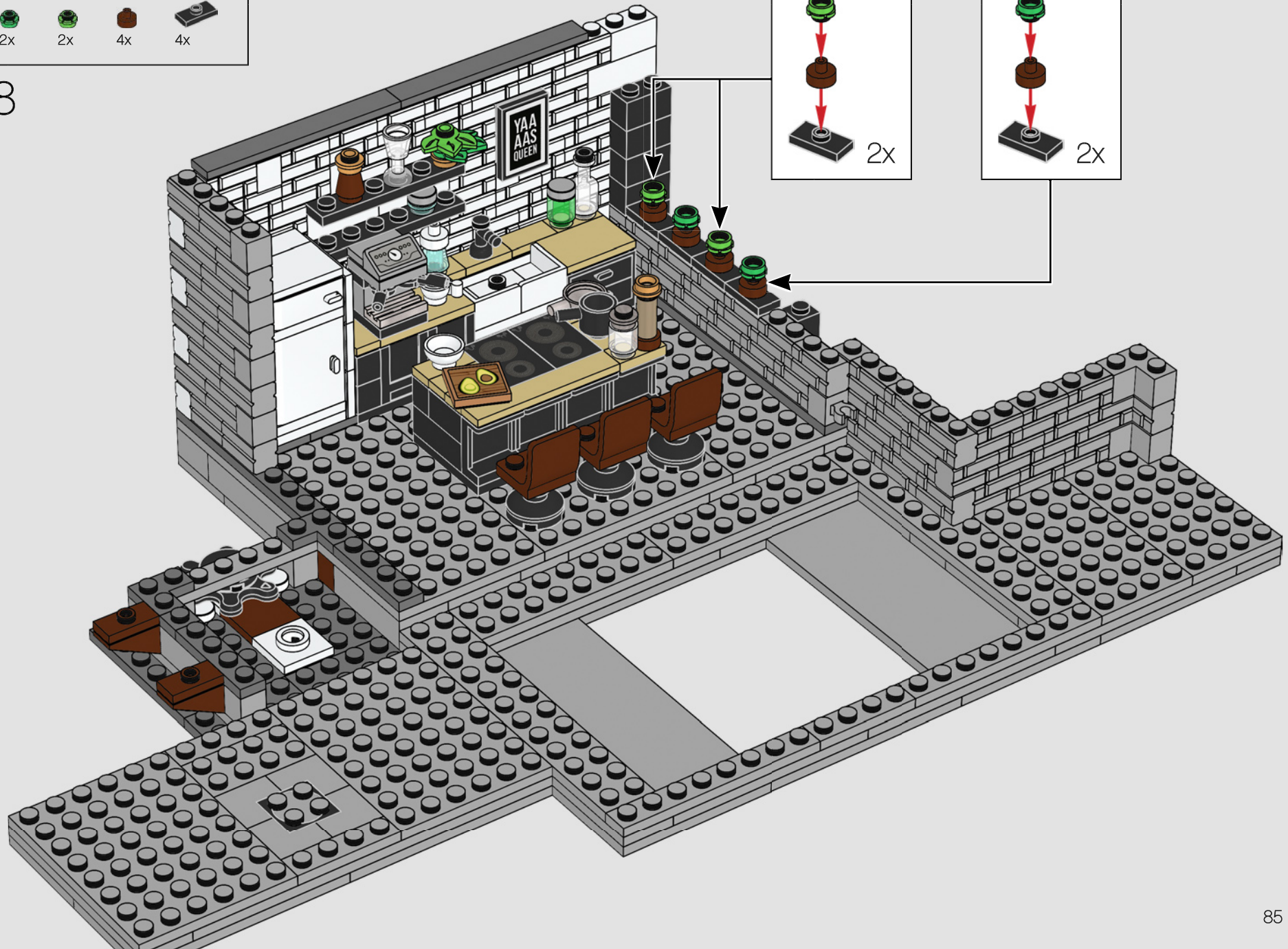
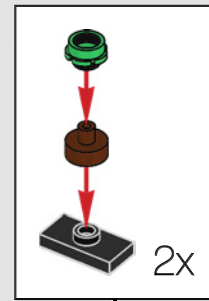
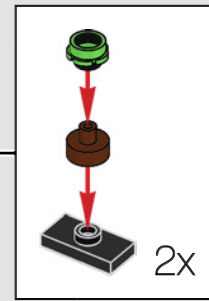

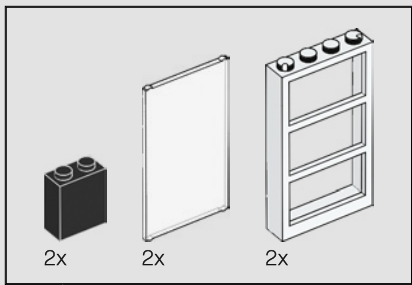

79

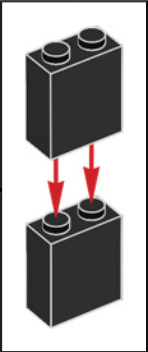
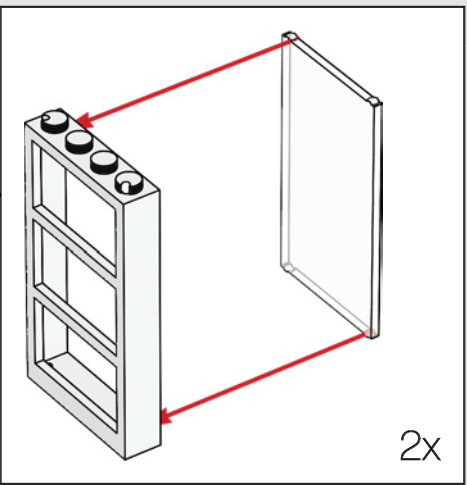
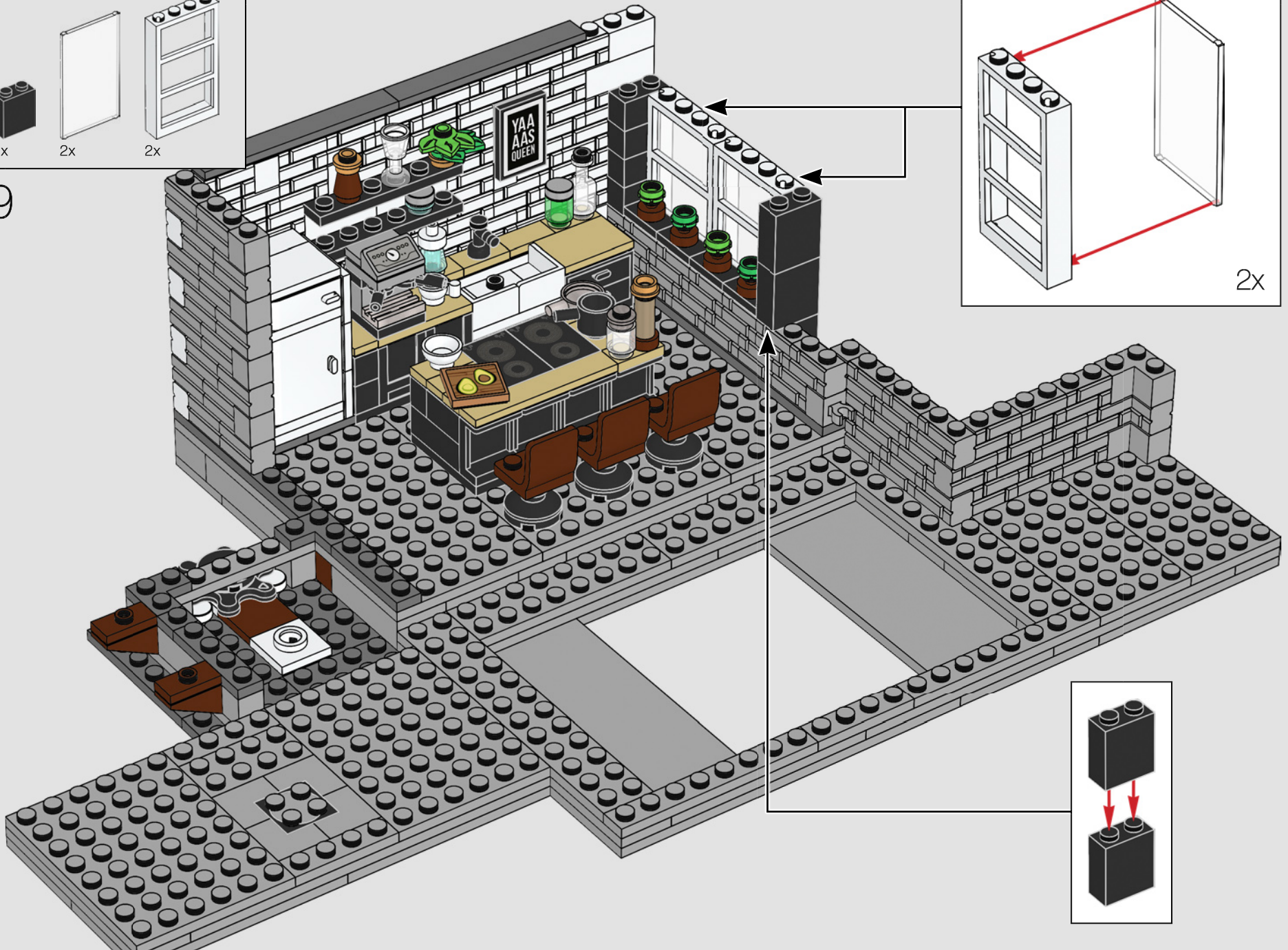

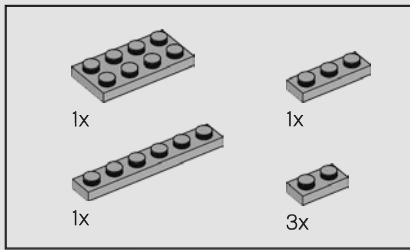

80

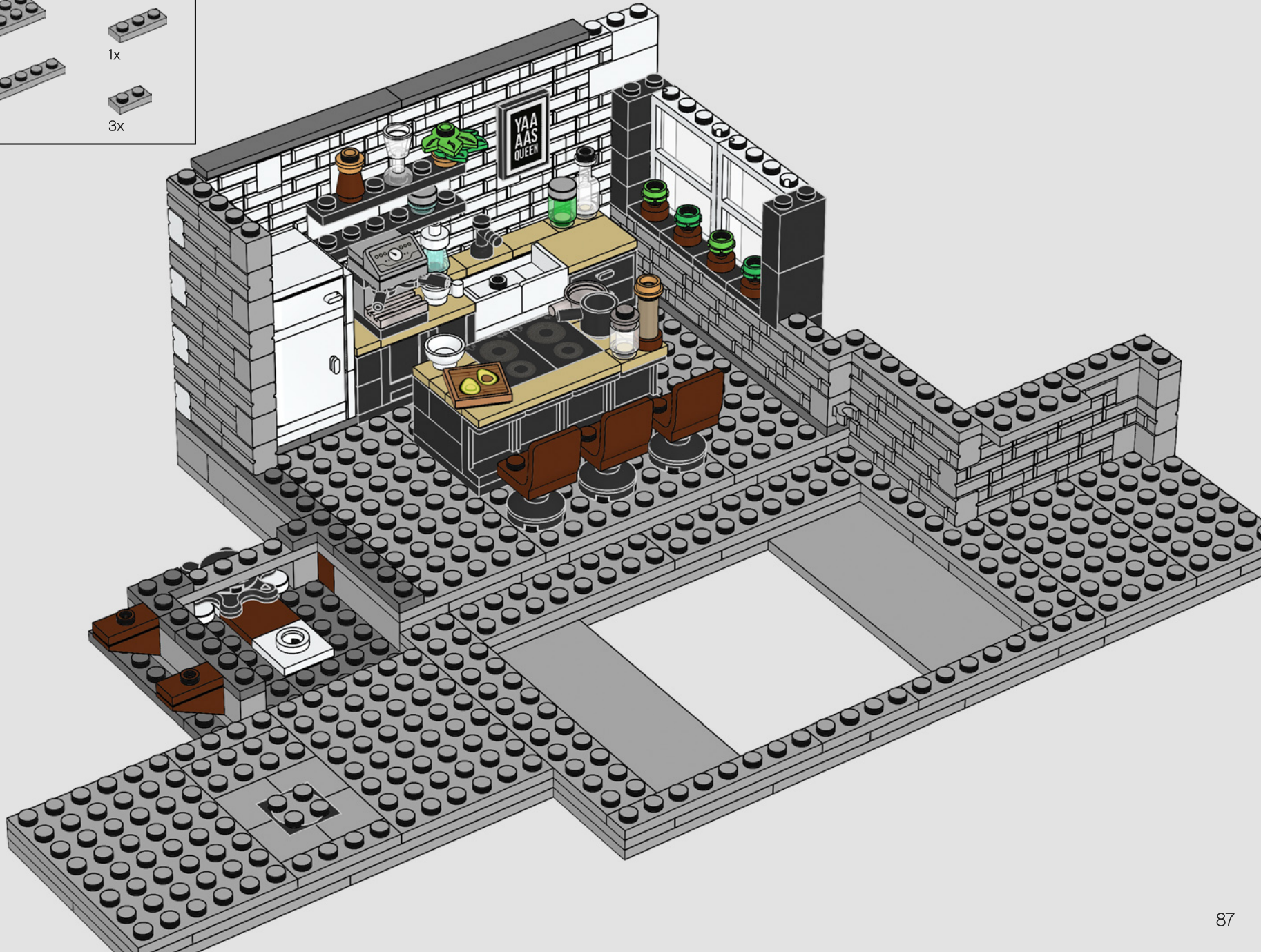

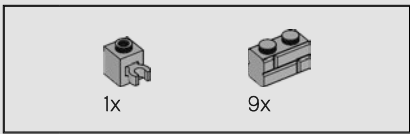

81



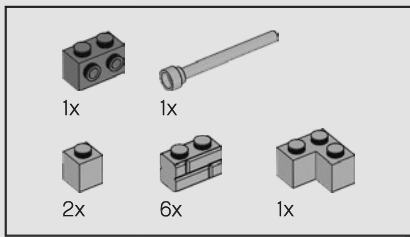

82

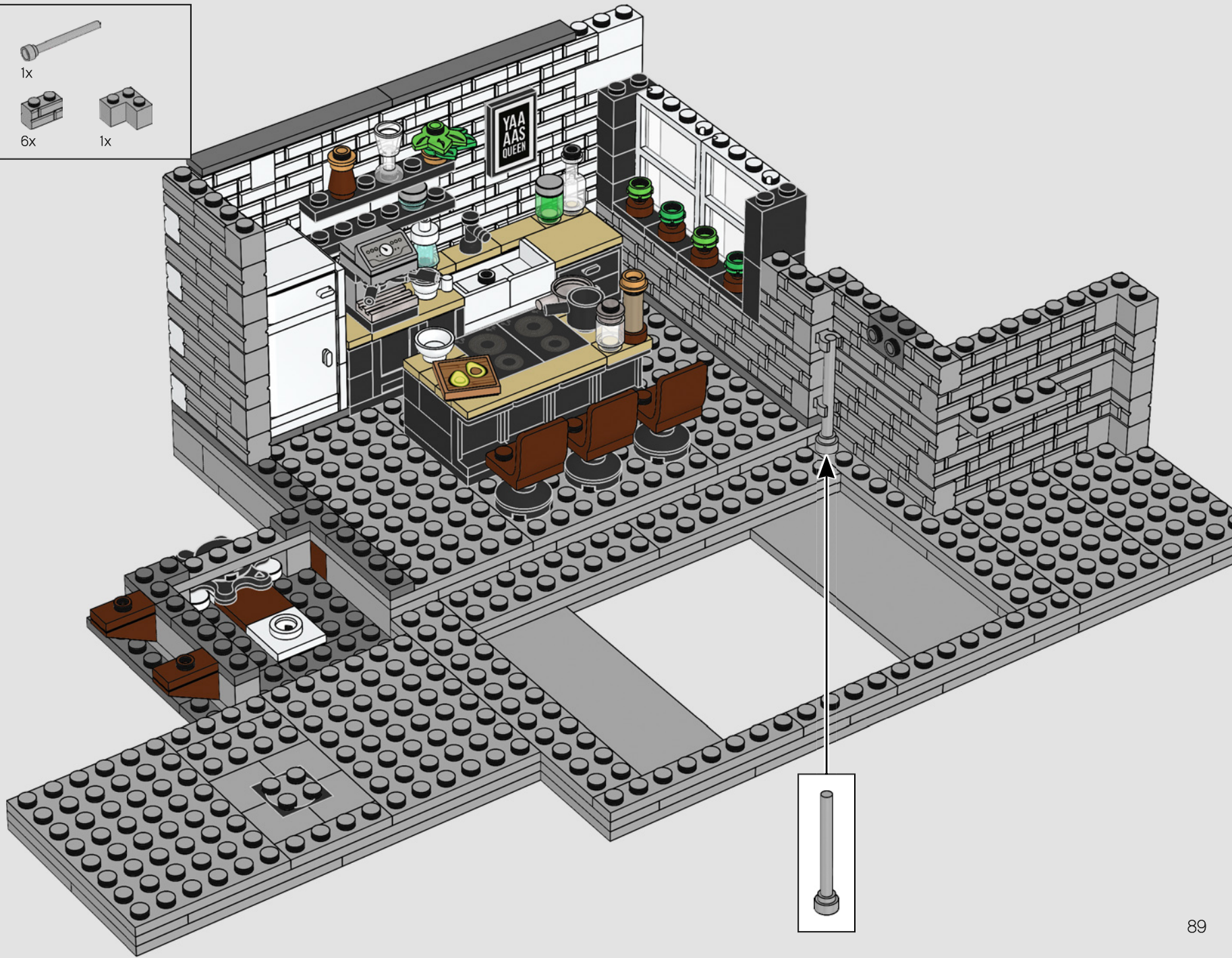

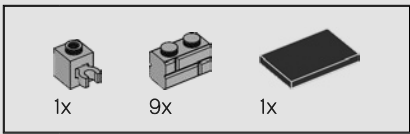

83

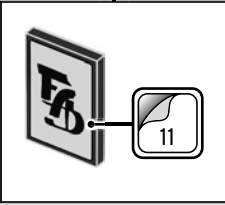
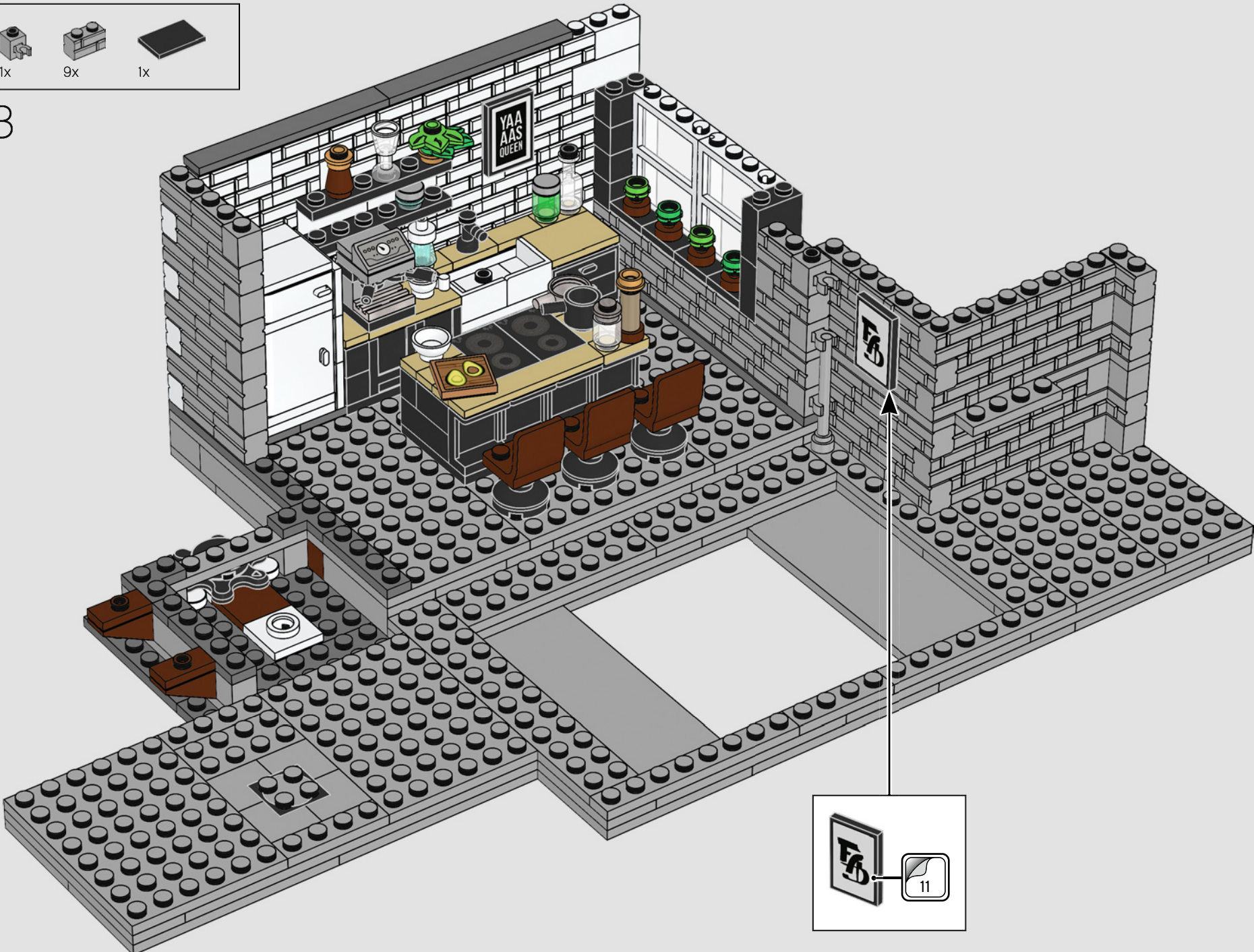

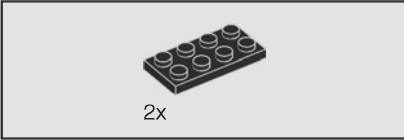
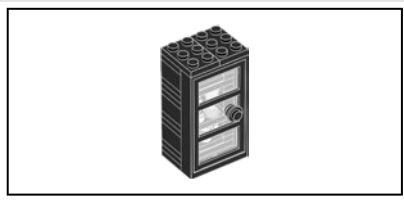

2x

84

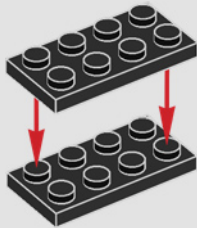

1x

2x

85

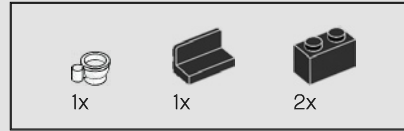
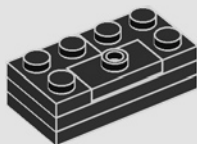

1x

1x

2x

86

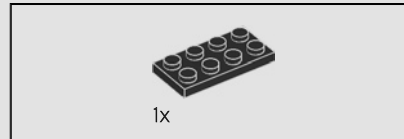
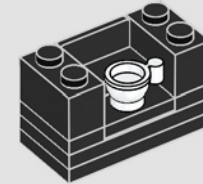

1x

87

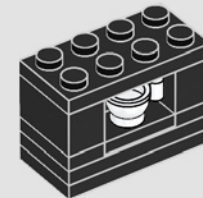



88

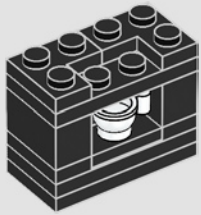

89



90

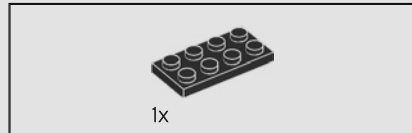

91

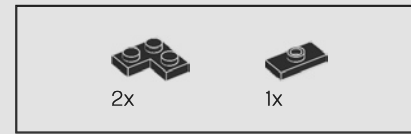

92

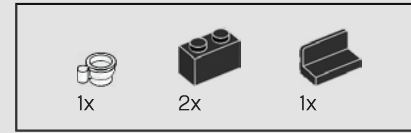

93



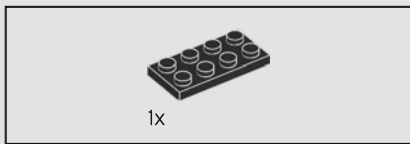

94

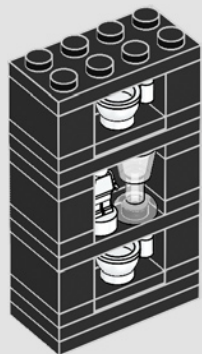

95

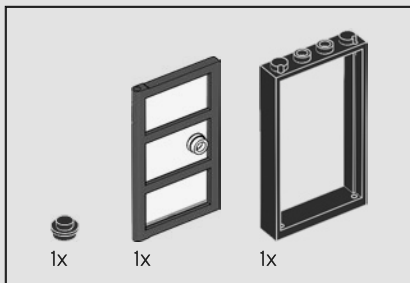
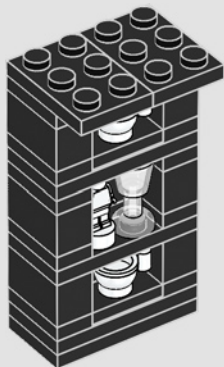

96

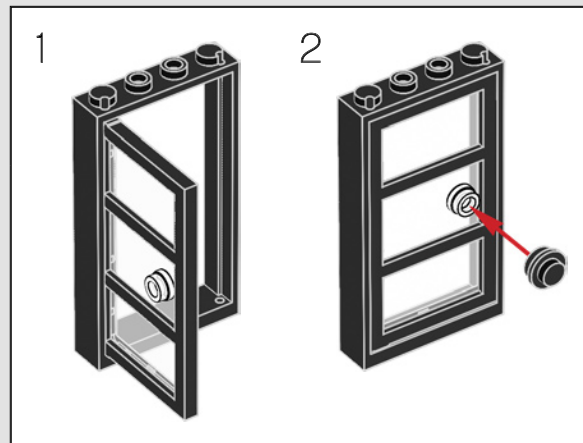
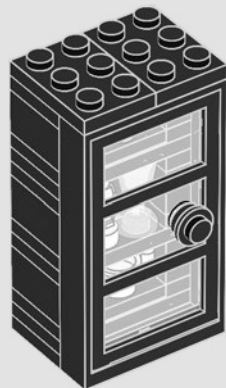

安东尼·波罗夫斯基

“乐高®一路陪伴我的成长，是我最喜欢的玩具。我会拼搭城市、海盗船，然后摧毁它们，再重新开始。想到年幼的孩子现在可以拼搭和玩乐 LGBTQ+ 主题的玩具，简直令人不可思议。我很荣幸能够成为这一特殊伙伴关系的一部分。十岁的安东尼的内心在嘶喊。”

97

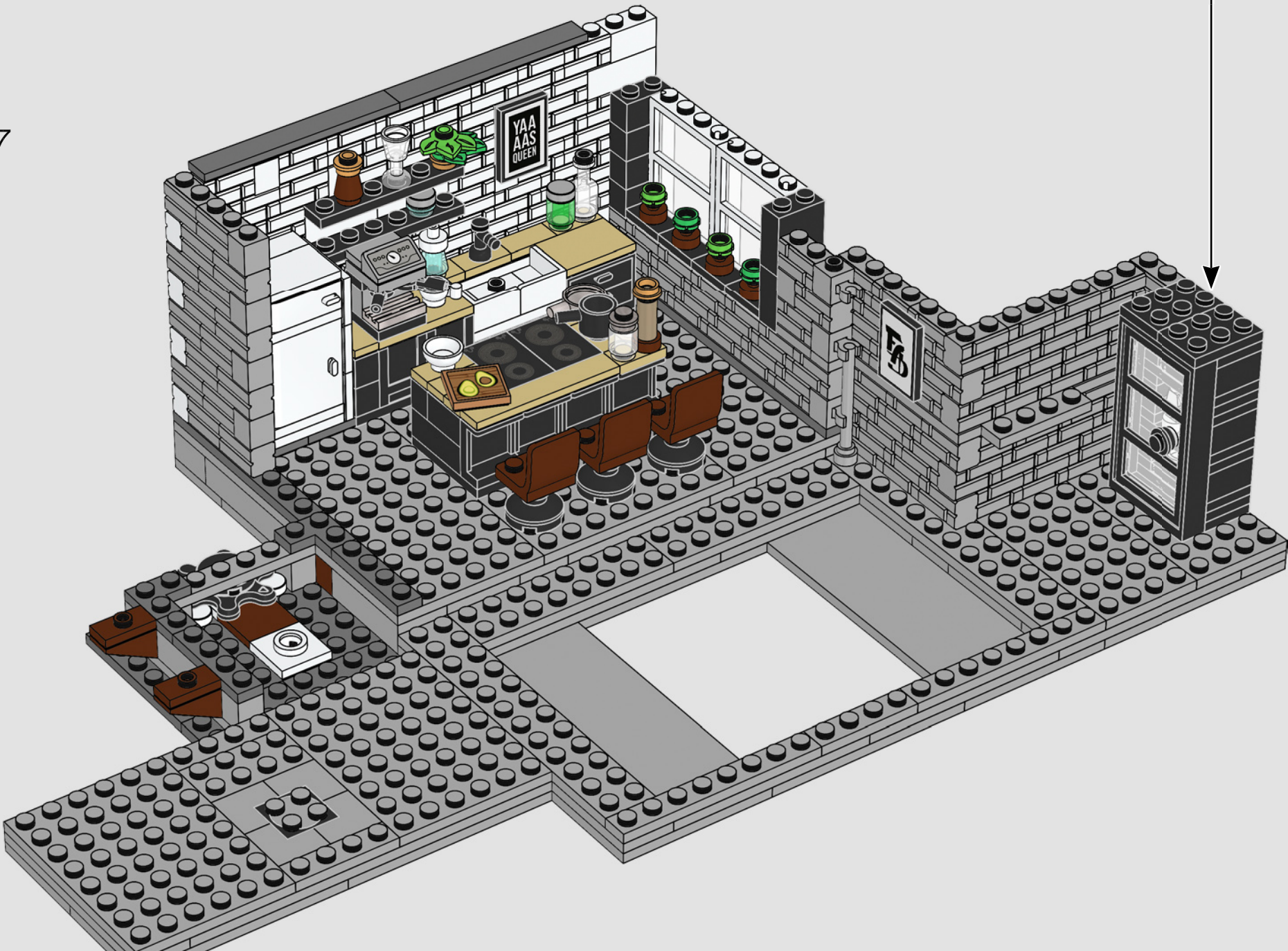

94

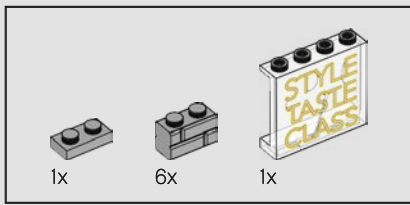

98

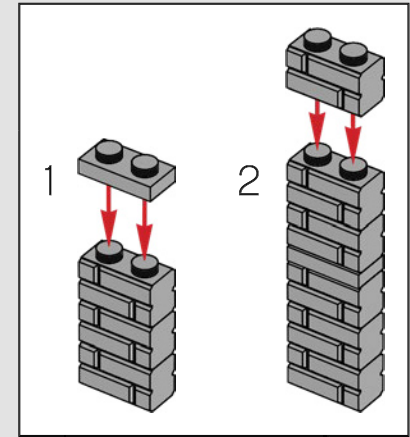
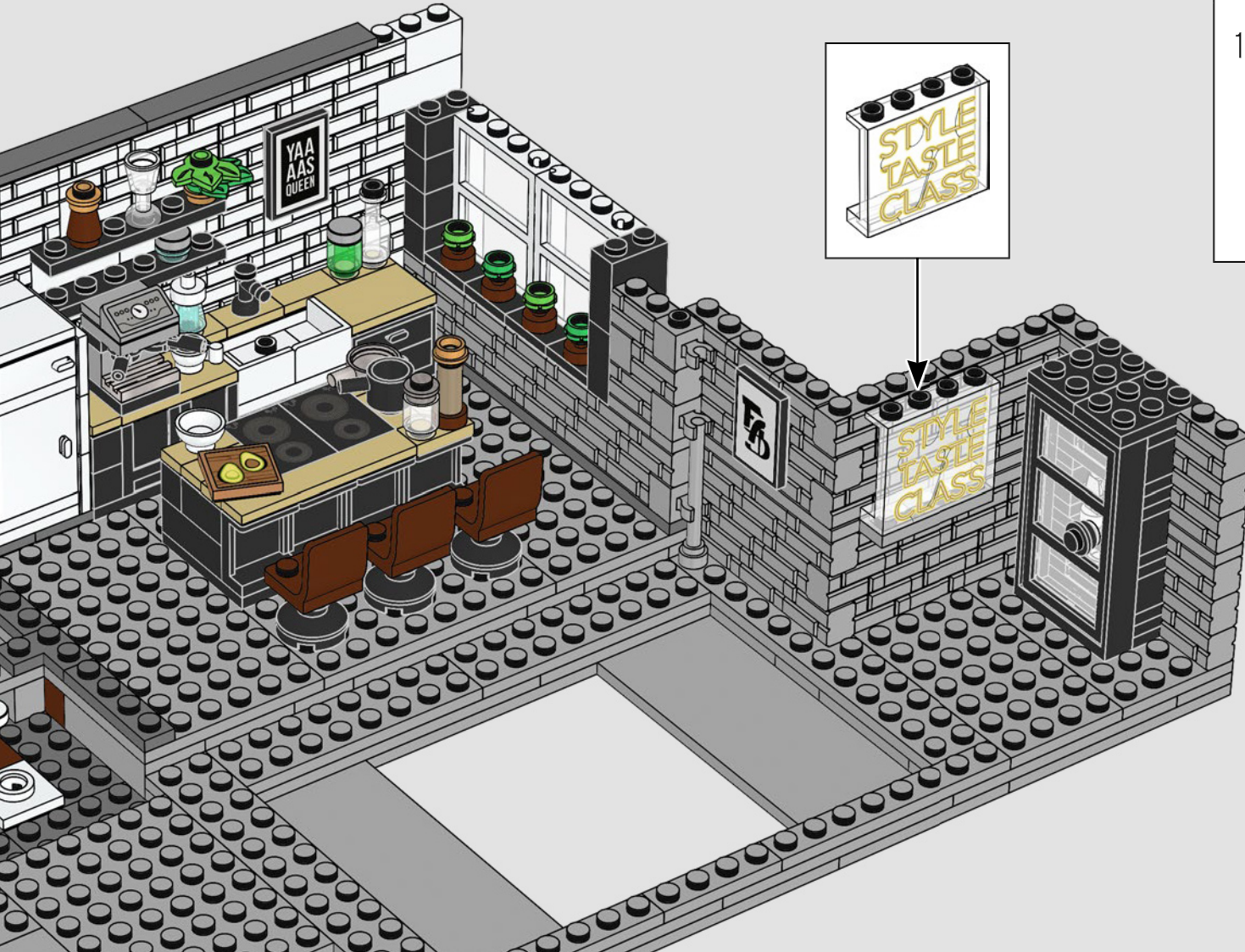

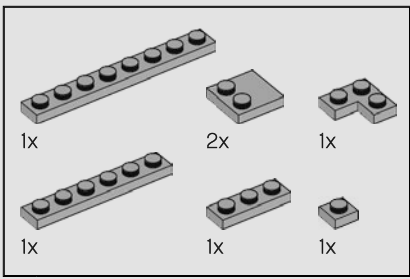

99



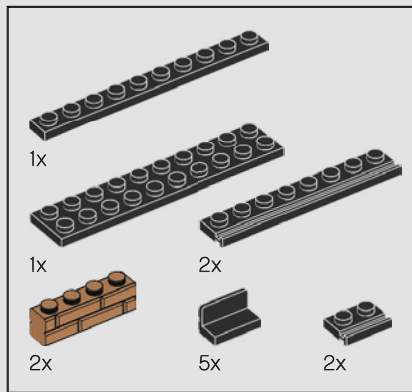

谭·法郎士

“我们神奇五人组在内心中都是小孩子，我们在《粉雄救兵》上做事情时有时感觉更像是在玩而不是工作。似乎我们非常适合与乐高®合作开发这款套装——一款深受所有年龄段孩子喜爱的玩具！”

100

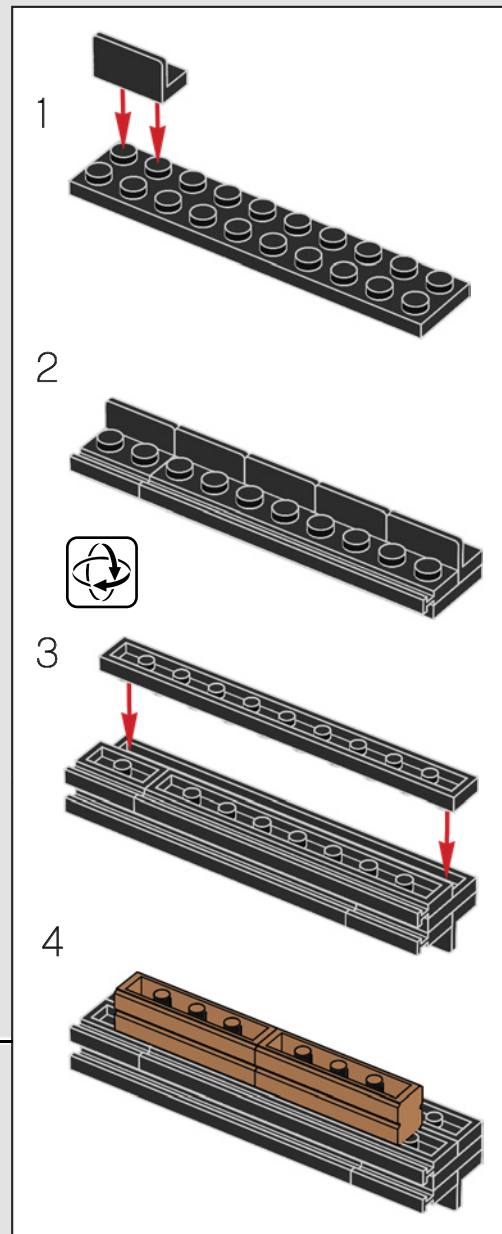



101



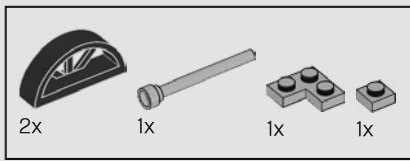

102

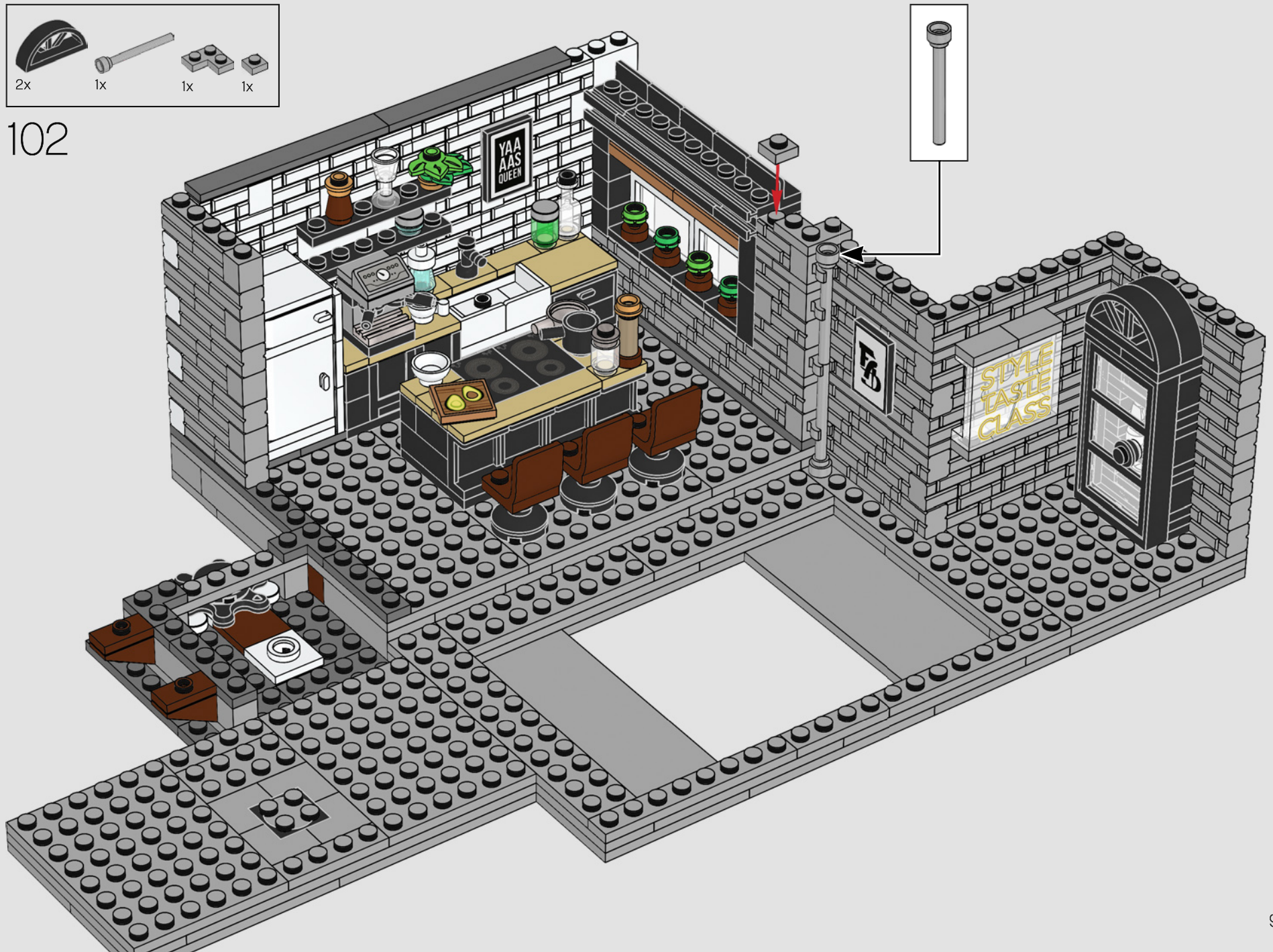



7x

103

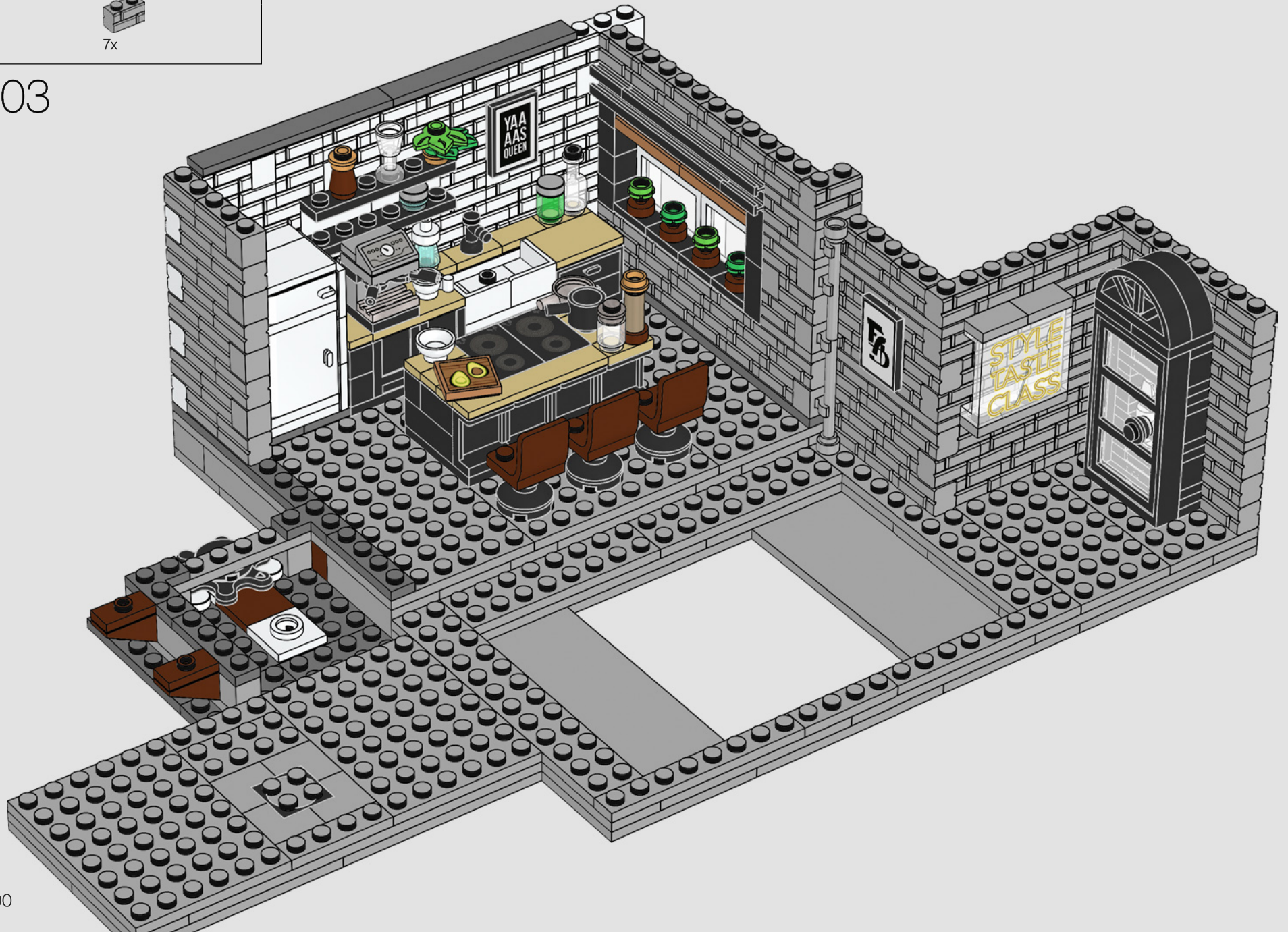

100

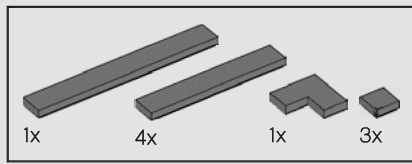

104



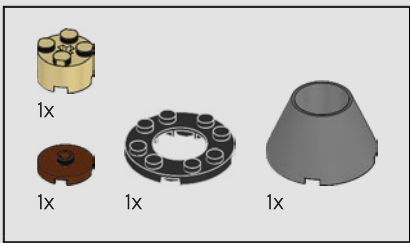

105

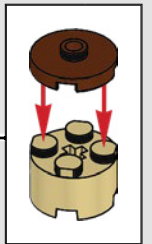
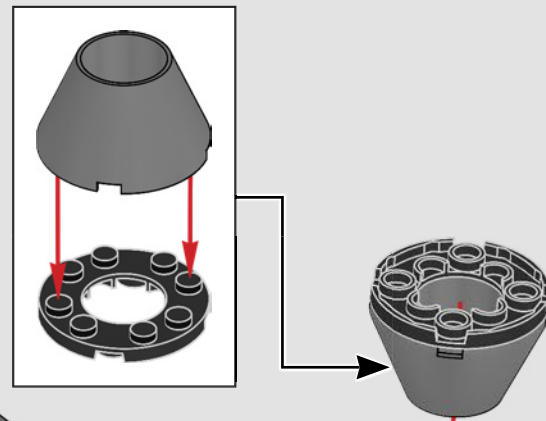

102

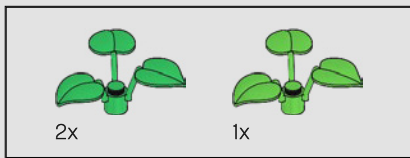

106

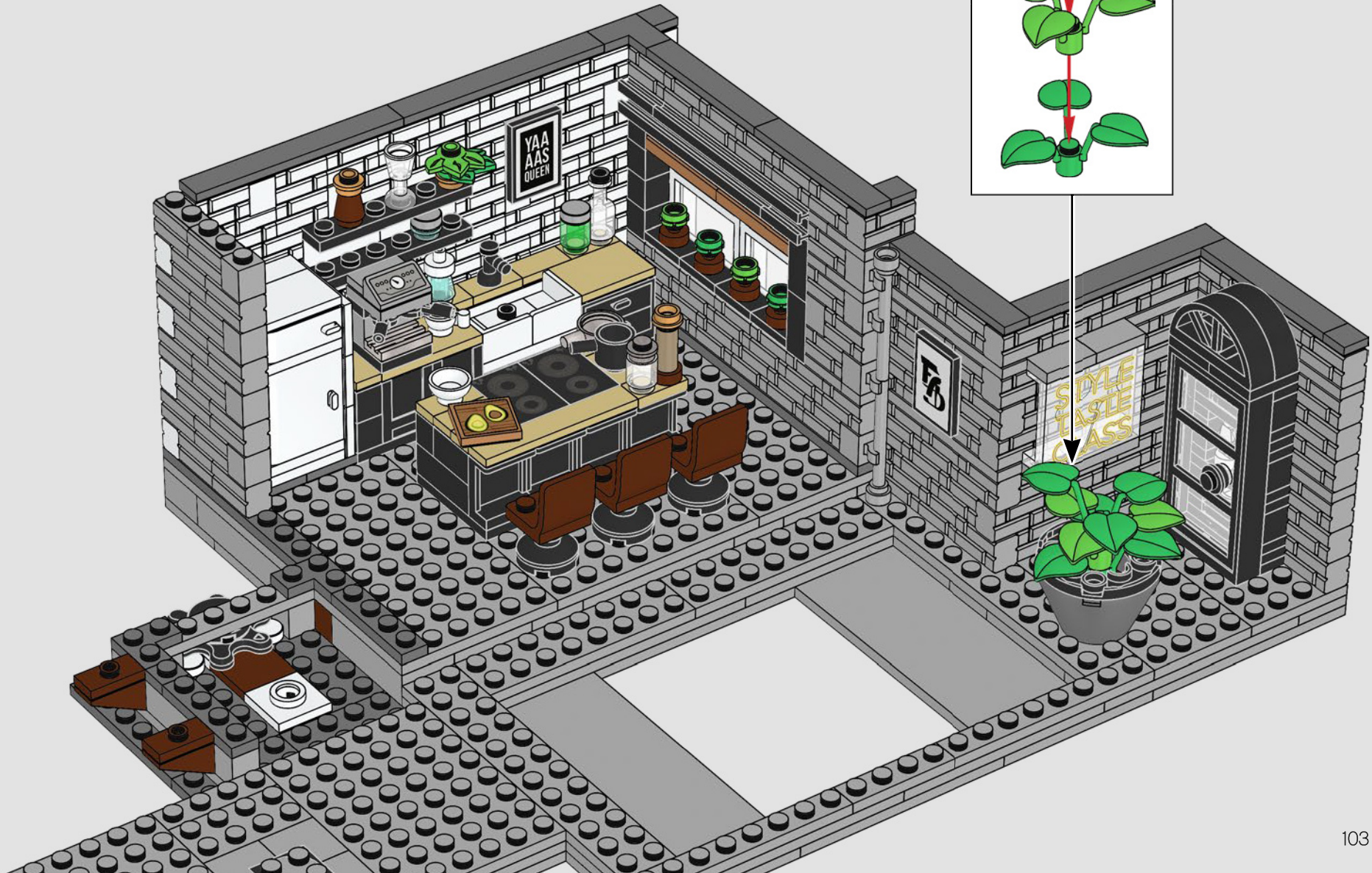

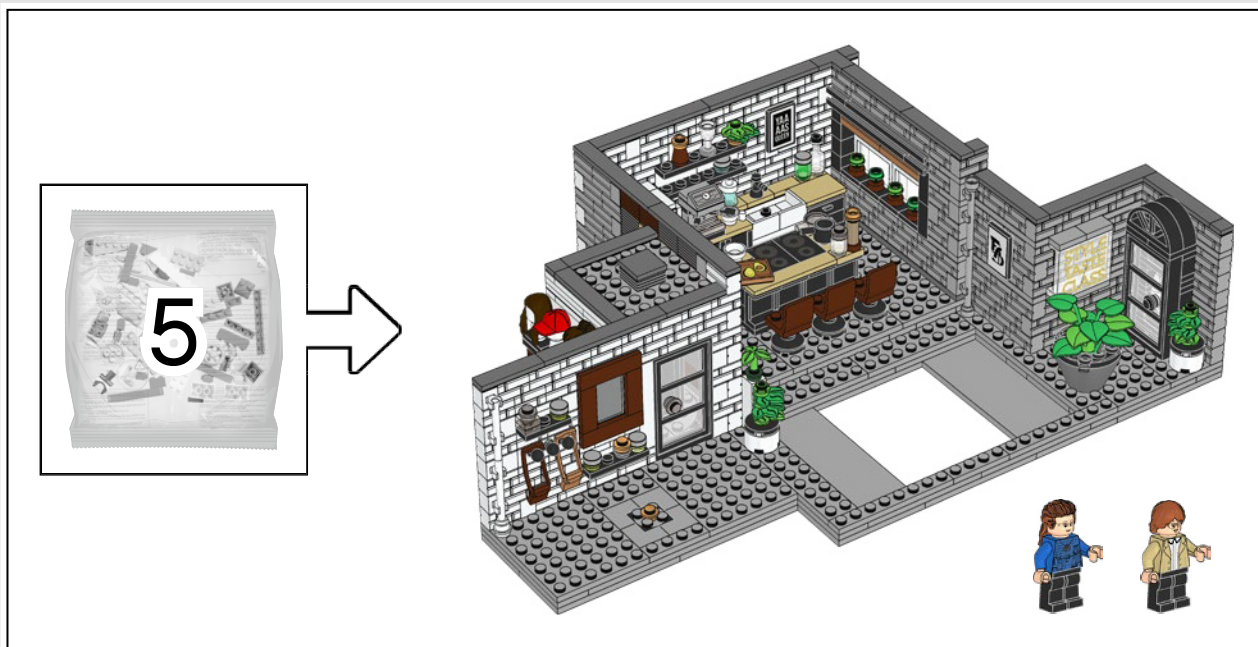

乔纳森·凡·奈斯

“非常高兴这款套装引入了 Kathi Dooley! 她是我儿时的英雄, 对我意义重大。另外, 我现在可以表演剪掉胭脂鱼发型了, 想剪多少次就剪多少次。”





107



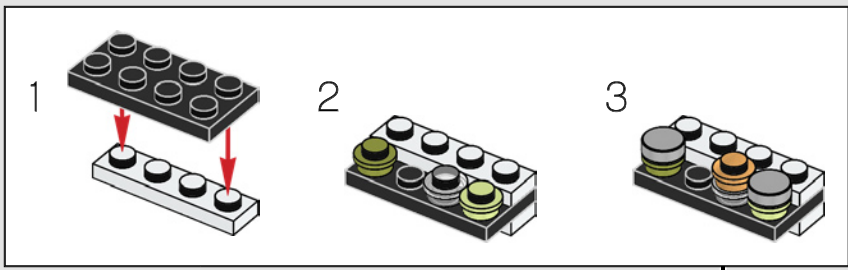
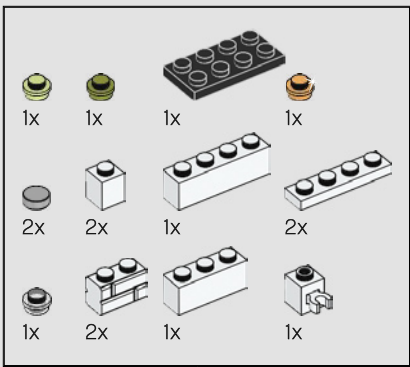

108



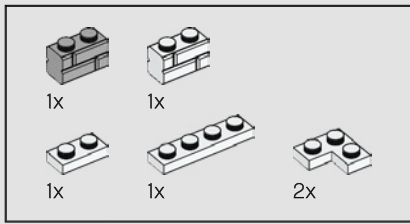

109



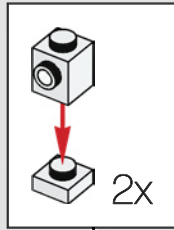
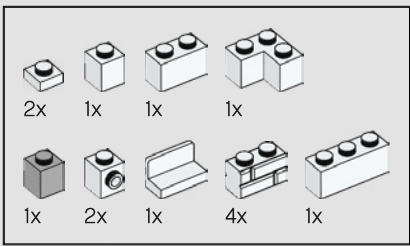

110



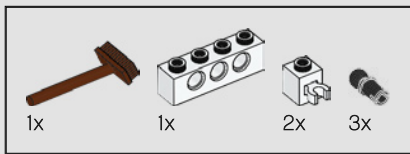

111

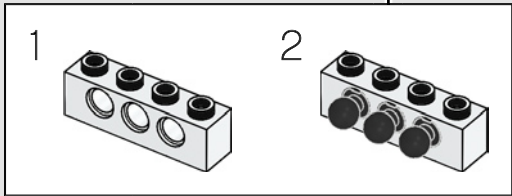
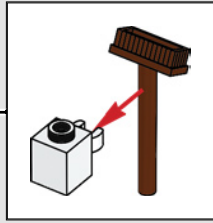

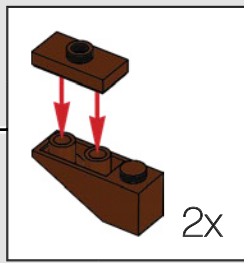
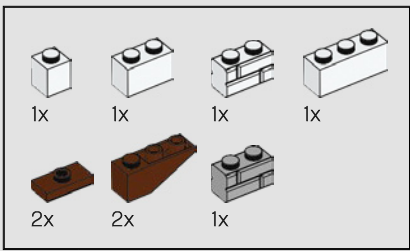

112



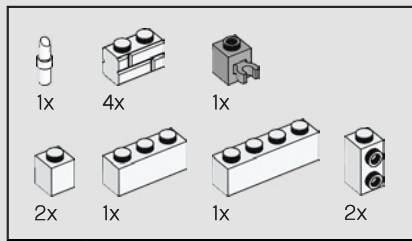

113

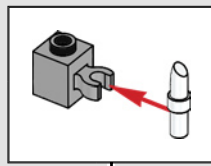

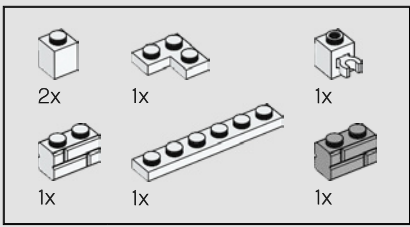

114



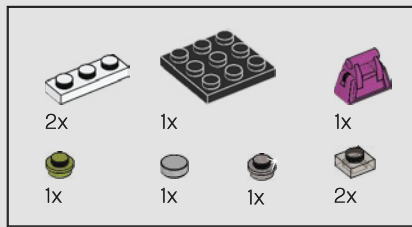

115

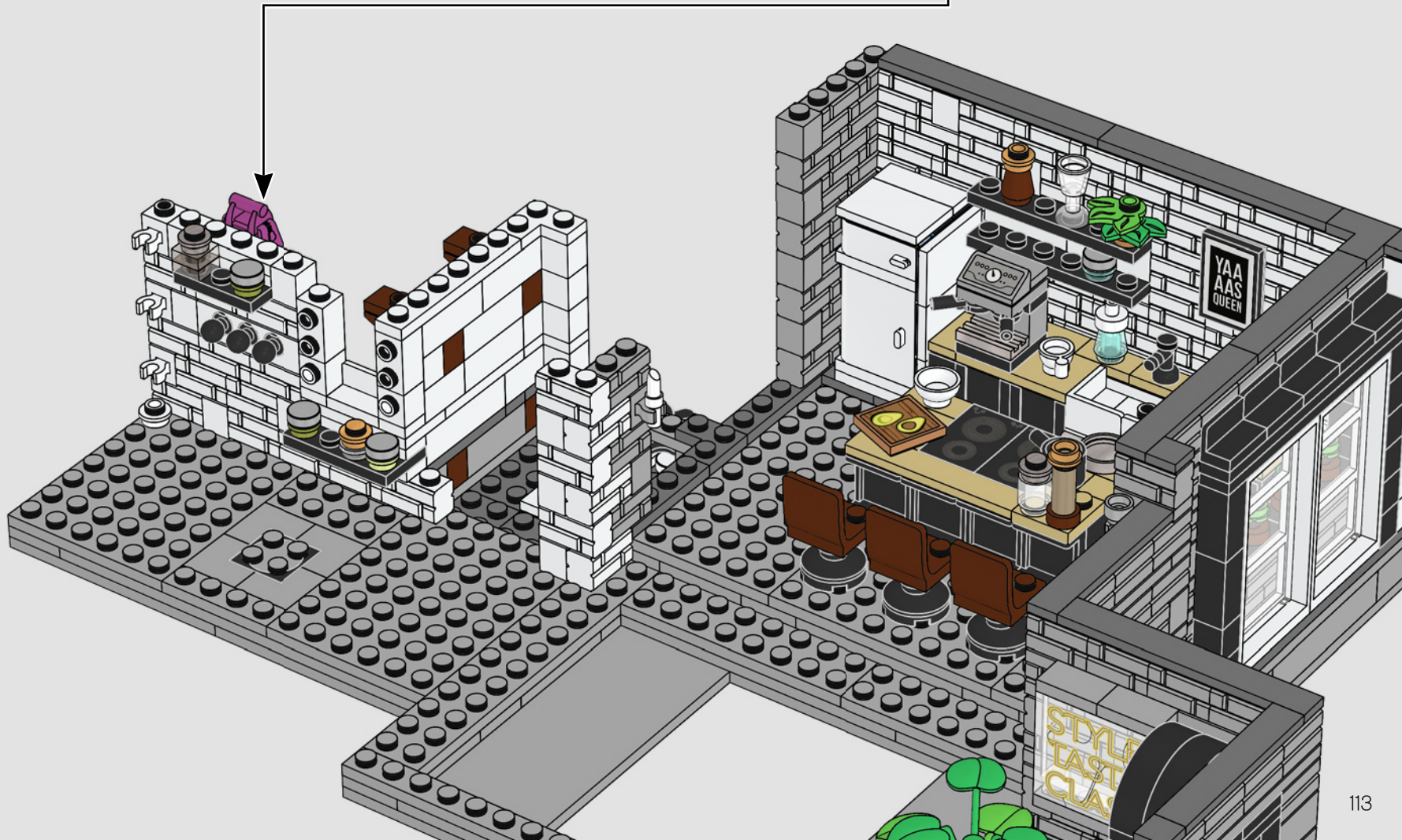
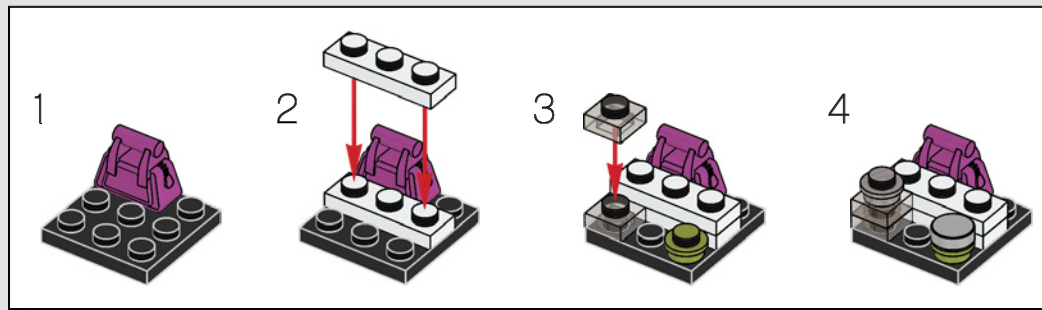

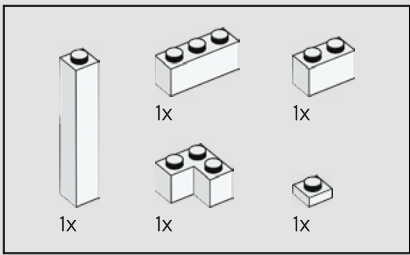

116



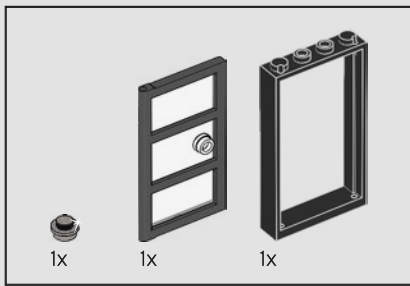

117

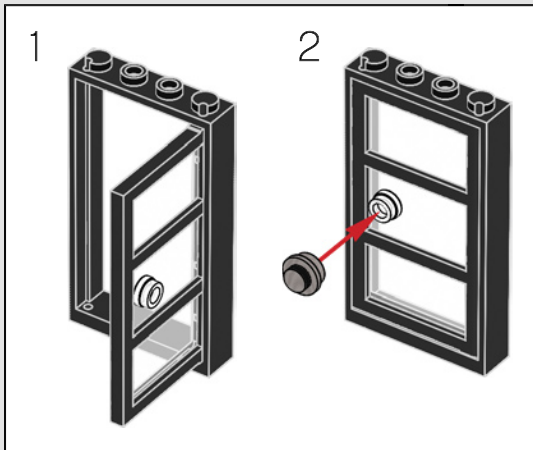

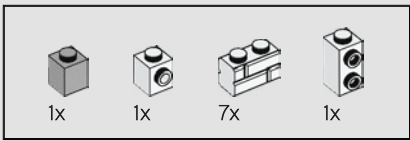

118



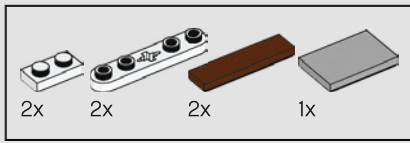

119

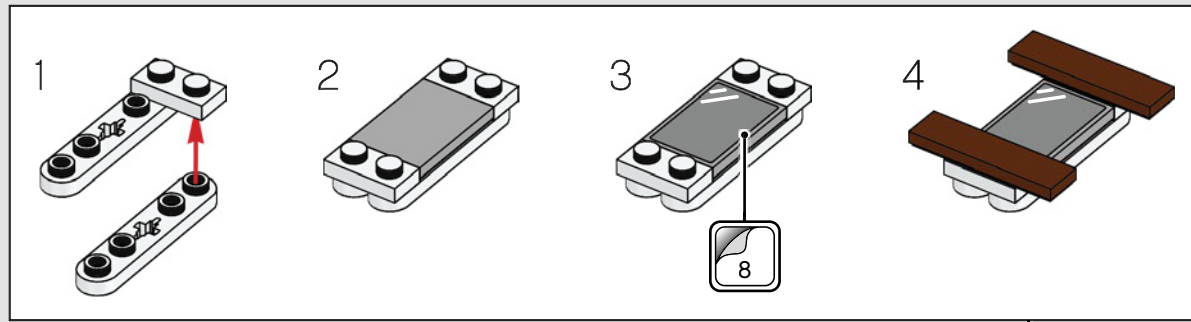

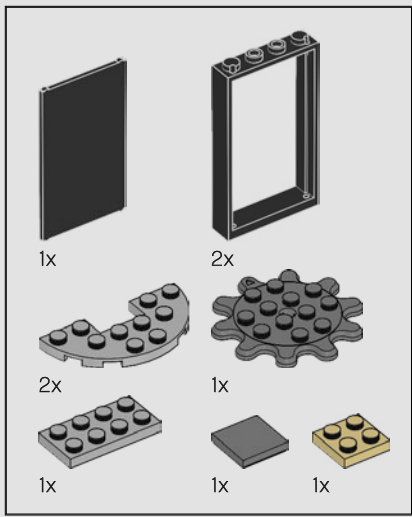

120

1

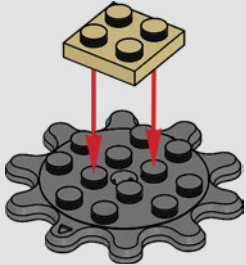

2

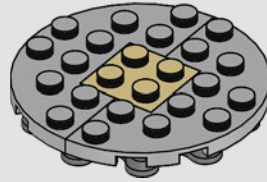

3

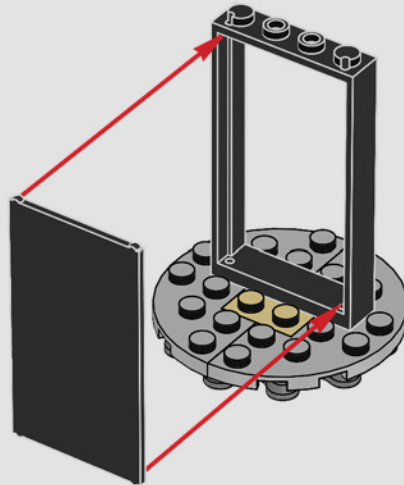

4

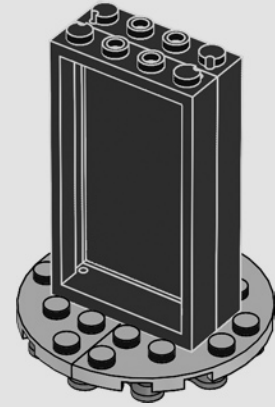

5

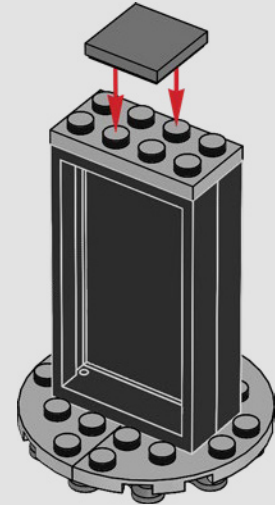



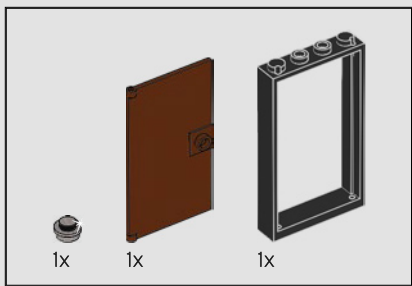

121

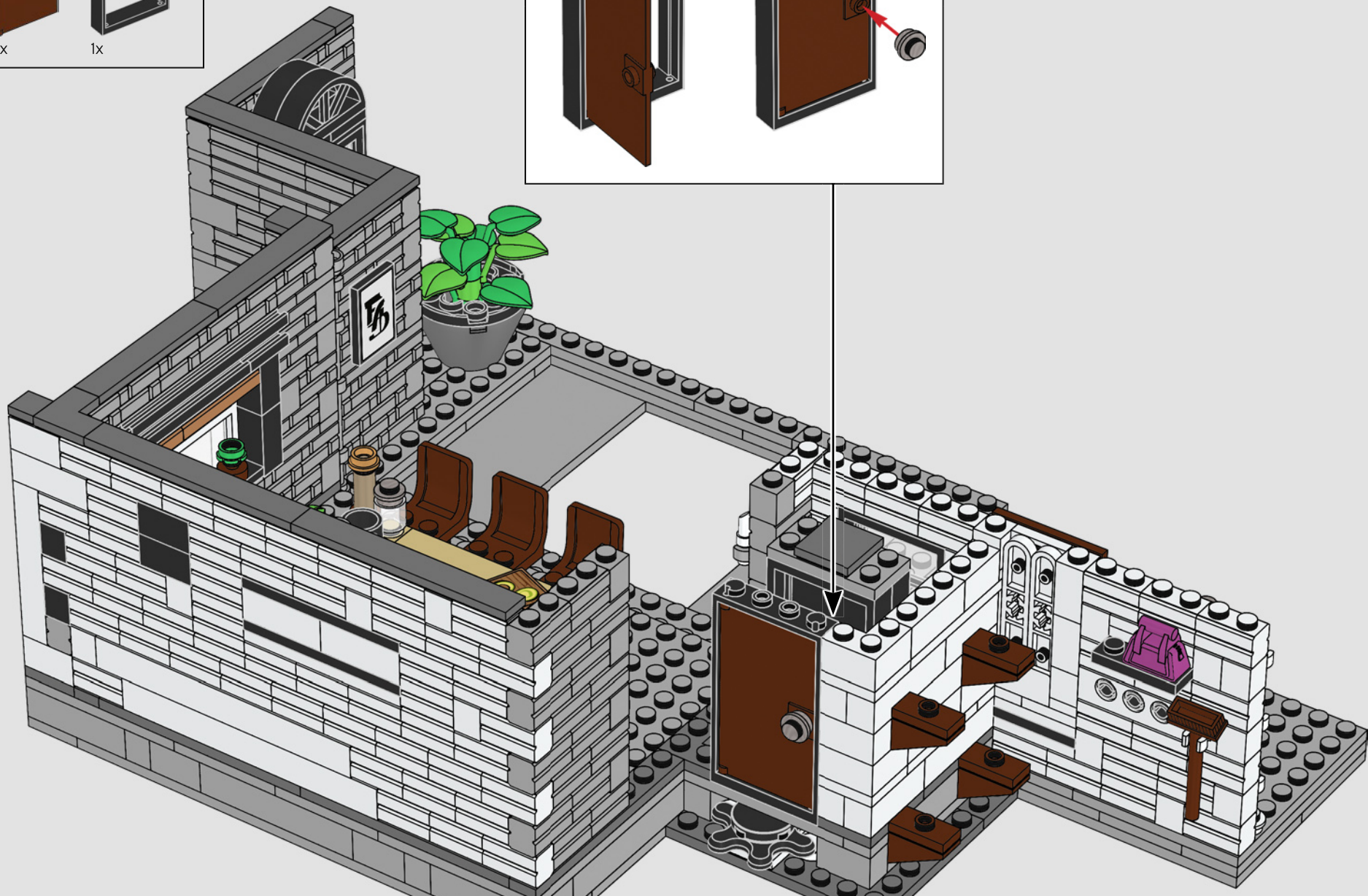
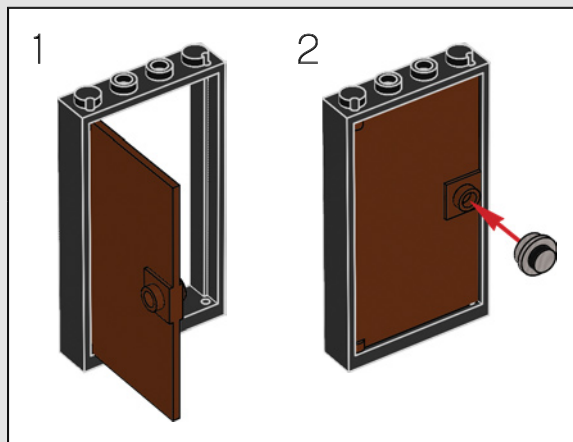

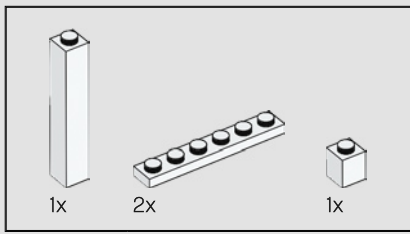

122

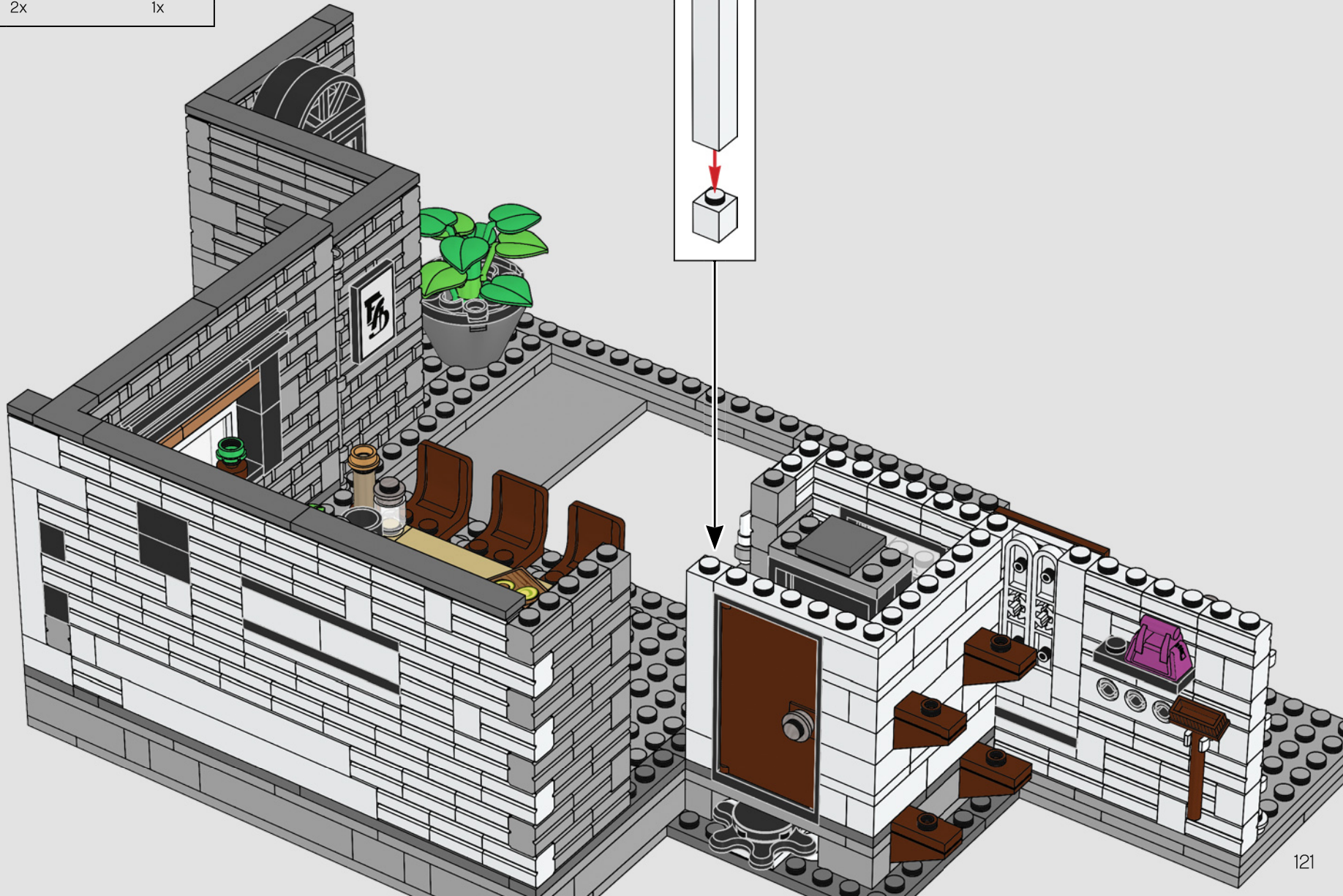

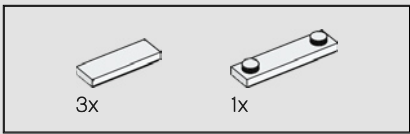

123

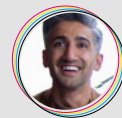

谭·法郎士

“我喜欢作为神奇五人组的一员，通过《粉雄救兵》，我可以向世人展示我们群体多样化之美。当我参加这个节目的试镜时，这是我的主要希望，我现在很感激能够拥有这个机会。”

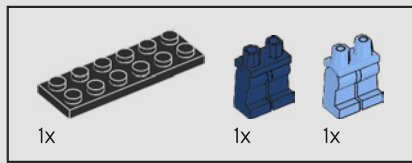

124

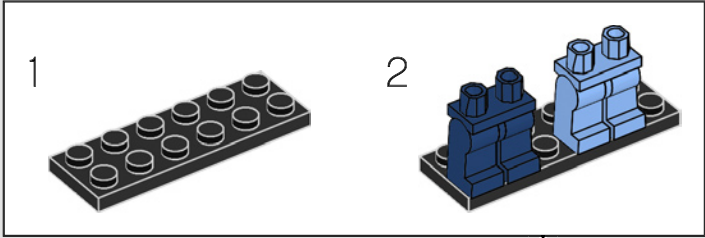
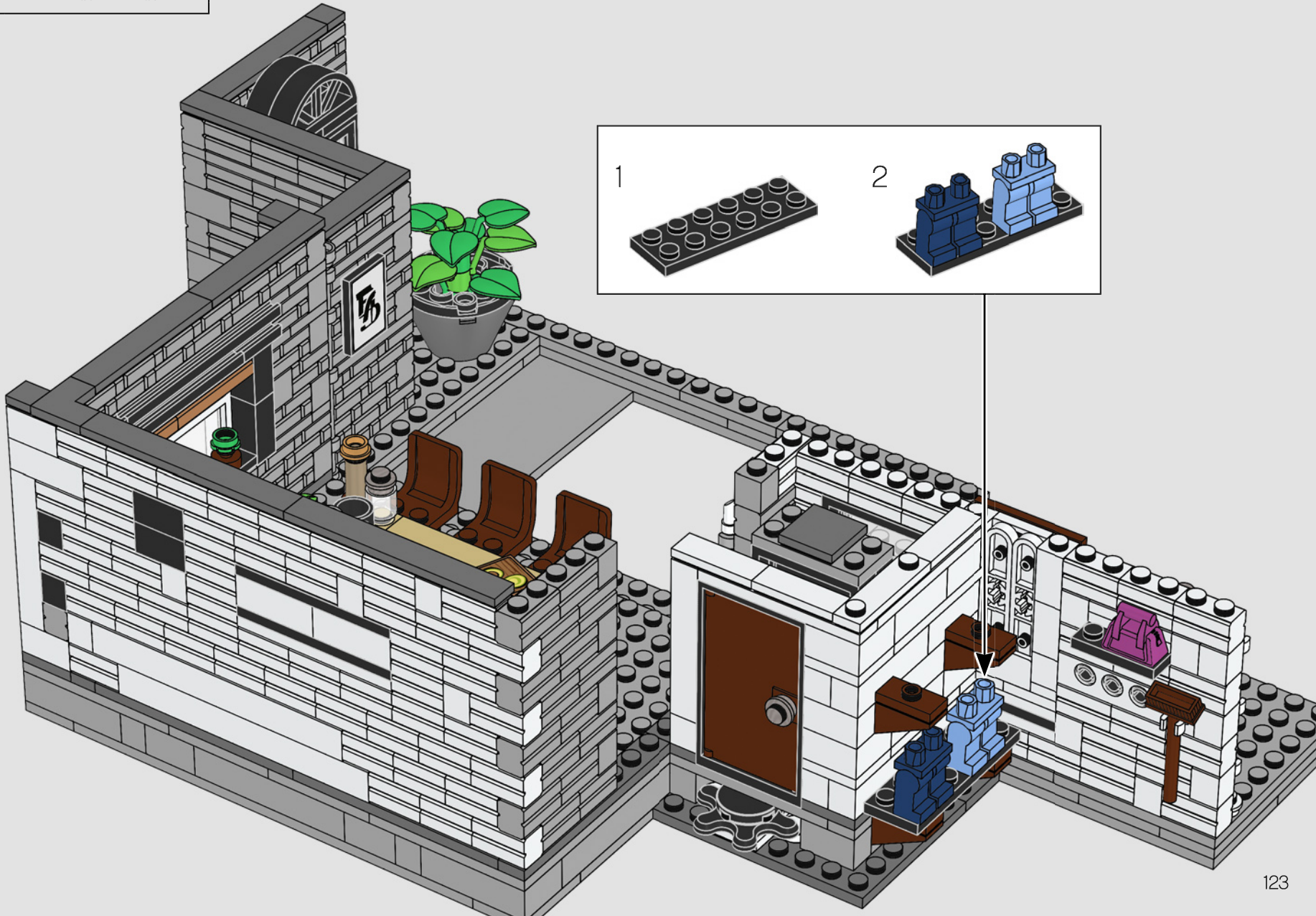

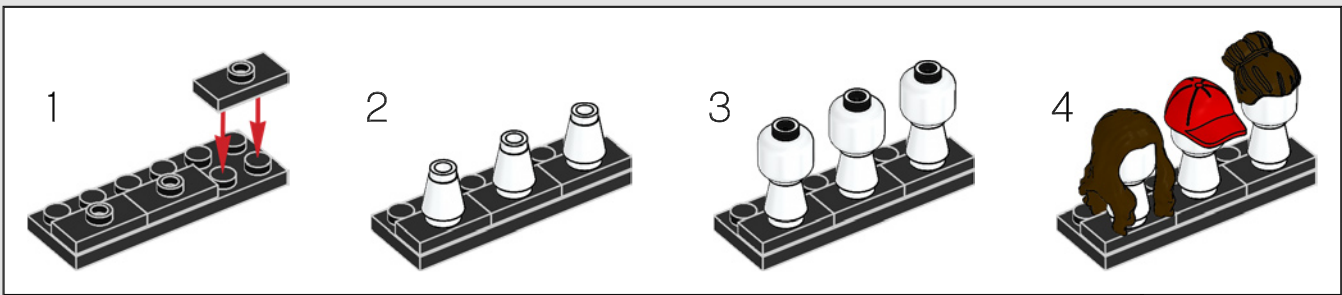
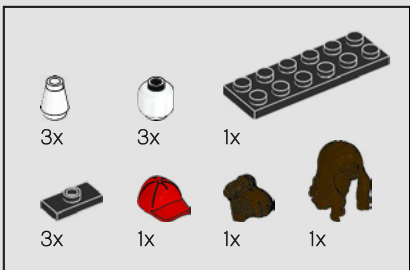

125



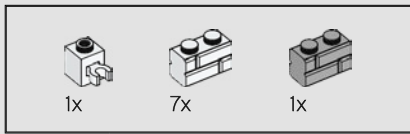

126



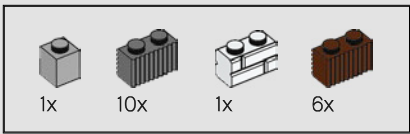

127

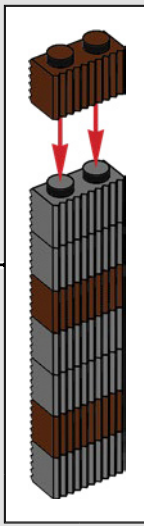
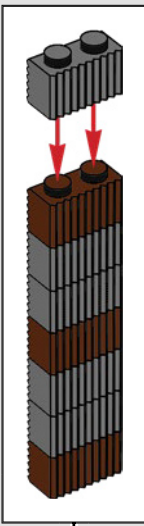

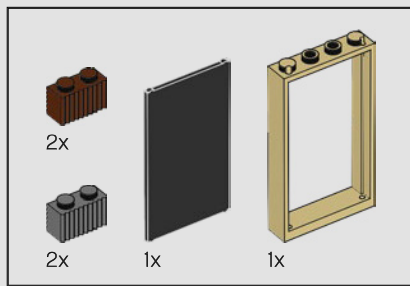

128

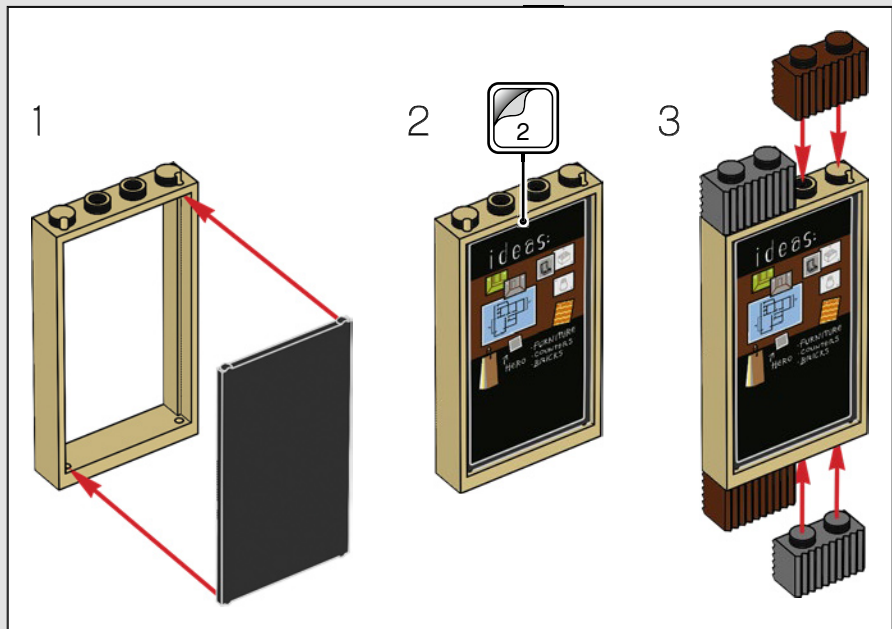

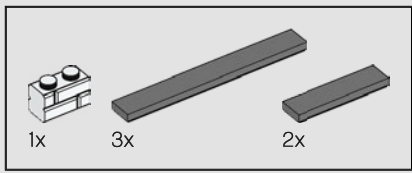

129

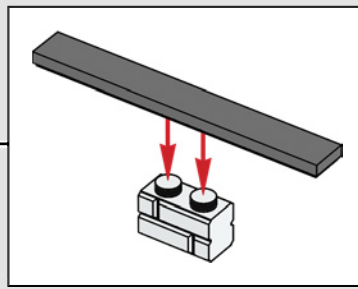

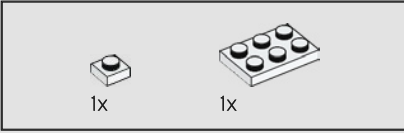
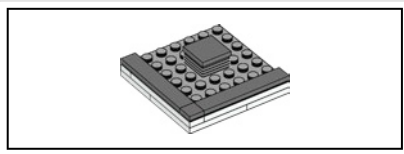

130

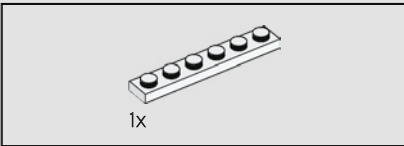
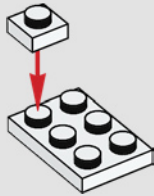

131

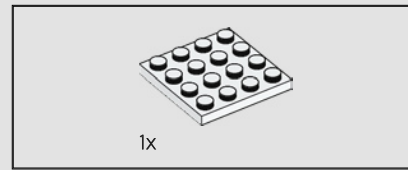
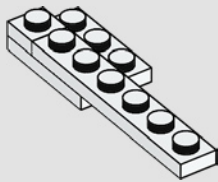

132

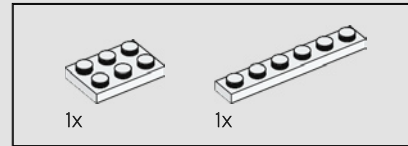
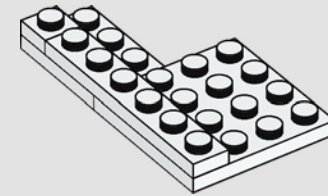

133

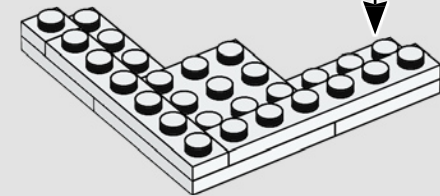
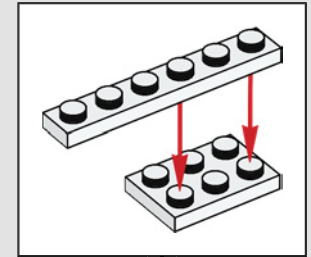

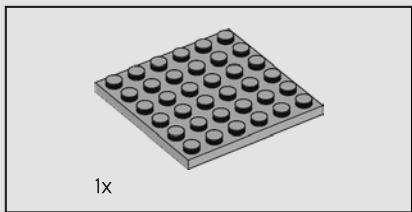

1x

134

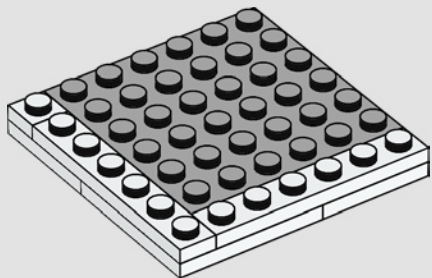

1x

1x

135

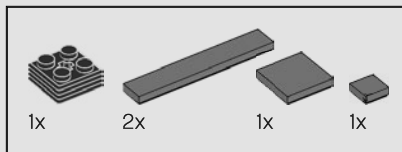
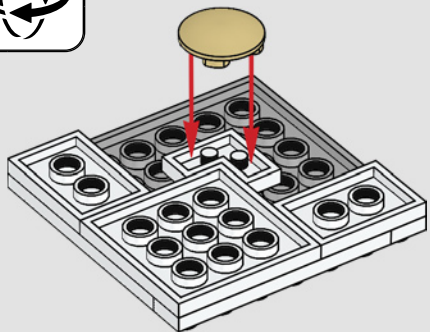

1x

2x

1x

1x

136

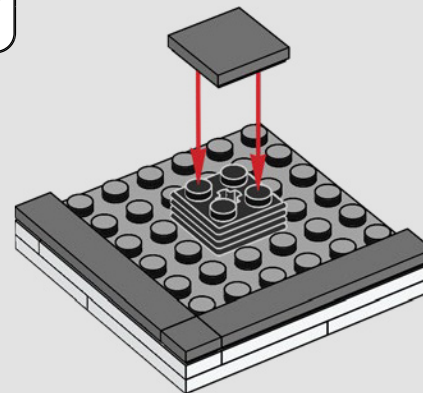

谭·法郎士

“那个改造房间太棒了！只需一转，‘Ta-daaa!’，奇迹出现！”

137



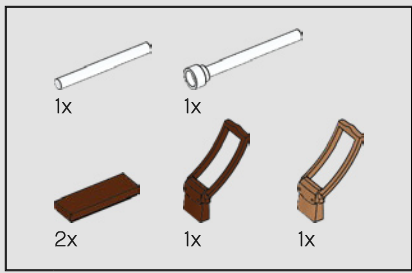

138



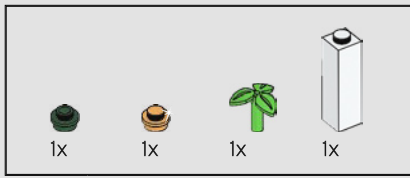

139

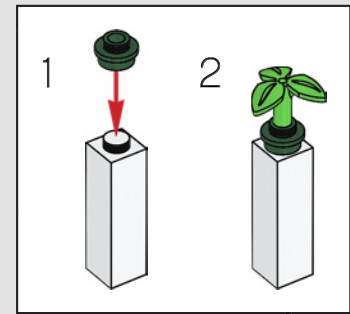

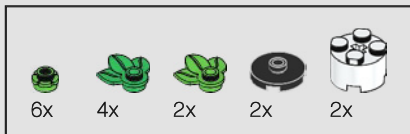

140

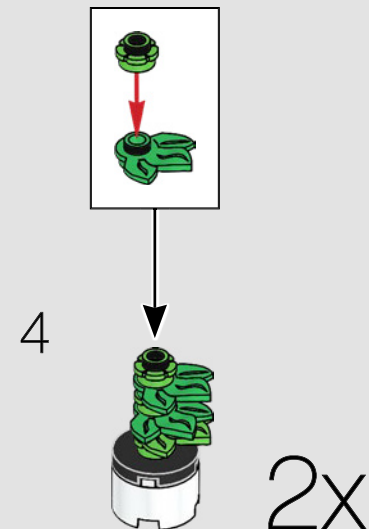
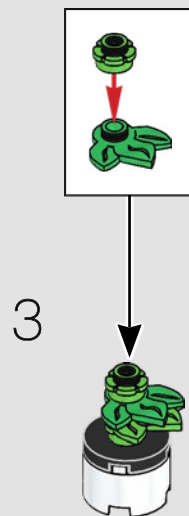
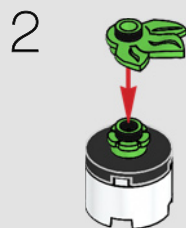
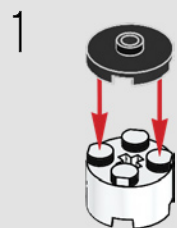

卡拉莫·布朗

“作为一个成人，任何创造过程都有助于你集中注意力，自由发挥创造力。使用乐高®进行拼搭是一种很好的放松和减压方式，同时你所创造的任何事物都可以为自己带来真正的成就感。就像我们的节目一样，乐高有助于从细微处衔接人们的生活。这是一次完美的合作。”





“看到最终的套装，我非常开心。我认为，我们已经全力捕捉真实阁楼中所有物品的精髓了！”

鲍比·伯克





FEEDBACK AND WIN



FEEDBACK AND WIN

Your feedback will help shape the future development of this product series.

Please visit:

FEEDBACK UND GEWINNEN

Dein Feedback trägt zur Weiterentwicklung dieser Produktreihe bei.

Geh auf:

COMMENTEZ ET GAGNEZ

Vos commentaires nous aideront à concevoir les futurs produits de cette gamme.

Rendez-vous sur :

COMENTA Y GANA

Tu opinión nos ayudará a dar forma al desarrollo de esta serie de productos en el futuro.

Visita:

反馈有奖

您的反馈将有助于我们在今后改进本系列产品。

请访问：

[LEGO.com/productfeedback](https://www.lego.com/productfeedback)

By completing, you will automatically enter a drawing to win a LEGO® set.

Terms & Conditions apply.

Durch Ausfüllen nimmst du automatisch an der Verlosung eines LEGO® Preises teil.

Es gelten die Teilnahmebedingungen.

En envoyant vos commentaires, vous serez automatiquement inscrit(e) à un tirage au sort qui vous permettra de remporter un prix LEGO®.

Offre soumise à conditions.

Al contestar, participarás automáticamente en el sorteo y podrás ganar un set LEGO®.

Sujeto a Términos y Condiciones.

完成我们的反馈调查，即可自动进入抽奖环节，赢取乐高®套装。

适用《条款和条件》。





Customer Service
Kundenservice
Service Consommateurs
Servicio Al Consumidor
LEGO.com/service or dial



: 00800 5346 5555
 : 1-800-422-5346



LEGO and the LEGO logo are trademarks of the LEGO Group. ©2021 The LEGO Group.

©2021, Scout Productions, Inc. and the Queer Eye logo are trademarks or registered trademarks of Scout Productions, in the United States of America and elsewhere. All rights reserved.